



2025 / 2026 CATALOGUE

WORKSPACE OF TOMORROW



**DSOP Office System &
Supplies Sdn. Bhd.**

198601004479 (153639-H)

CONTENTS

01. INTRO

- 002 Contents
- 004 About Us

- 005 Space Planning

02. MESH SEATING

- 006 Enjoy & Ioo Elite
- 007 Posh & Duora
- 008 Malfa & Zedia
- 009 Vision & Era
- 010 Skylar & Zeta
- 011 Agata & Baron
- 012 Luce & Finora
- 013 Trio White & Black
- 014 Runa & Rex
- 015 Marca & Lumino
- 016 Pixie, Assa, Alda & Ciro
- 017 Spot, Enza & Sylphy
- 018 Elora, Orion & Novus
- 019 Meze, Eco & Glo
- 020 Surface, Zenith, Icon, Otis & Pro Mesh
- 021 Other

03. PU LEATHER / LEATHER SEATING

- 022 Bloom & Ares
- 023 Janeiro & Santiago
- 024 Lagender & Mirezza
- 025 Lapaz & Bogota
- 026 Spina & Fulgo
- 027 Kados & Cron
- 028 Keno & Cuseo
- 029 Natal & Folia
- 030 Aion & Typhon
- 031 Zaffa & Kastel
- 032 Elini & Silo
- 033 Smarty, Folio & Prime
- 034 Bruno, Ricco, Beyond & Savino
- 035 Other

04. FABRIC SEATING

- 037 Enna & Elini
- 038 Petina & Zante
- 039 Klaus & Kastel
- 040 Motto & Orsin
- 041 Ersa & Affino
- 042 Firenze & Rascal
- 043 Hut 1 & Hut 2
- 044 Savona & Malfa
- 045 Other

05. PRODUCTION SEATING

- 047 Production, Drafting & Typist Chair

06. BENITHEM SEATING

- 048 Dynamic Plus & Hugo II
- 049 Palette II & B-Ximple Eco
- 050 Flow Basic, Z365 & Fein
- 051 Fein Lite & Body Lite
- 052 Knight Eco & Bc3
- 053 Flow-Premium, B-Ximple, Flow-White, B15 Plus, Palette II White & B11 Plus

07. SETTEE

- 054 Prestige, Tomato & Hector
- 055 Miller, Chime & Maxima
- 056 Kahiki, Zita & Kimberly
- 057 Urban, Louft & Shade
- 058 Rowena, Kris & Timeless
- 059 Focal, Basilo & Gelso
- 060 Mako, Yoyo & Nikola
- 061 Union, Key Factor & Saddle
- 062 Konnect, Milano, Lola, Ryder, Noor, Razar, Kamiivo, Myna, Key, Emboss, Lennox & Muzzie
- 063 Aglio, Borlotti, Carota, Mandorla, Mora, Susina, Arancia, Fragola, Limone, Zucca, Menta & Cipolla
- 064 Fluido, Sovo, Napa, Nismo Yarra, Komo, Jayna, Kasumi, Vesper, Akira, Pedro & Alita

08. COFFEE TABLE

- 065 Coffee Table

09. DIRECTOR / MANAGER / EXECUTIVE DESK

- 066 Lux
- 067 Grande
- 068 Havana
- 069 Veneto
- 070 Krest
- 071 Denver
- 072 Vortex
- 073 Evoke
- 074 Lutz
- 075 Alexis
- 076 Lattice
- 077 Maven
- 078 Archer
- 079 Mensa 88, Mensa 66, Mensa 55, Mensa 52 & Mensa 32
- 080 Belton, Alva, Capri, Sen II & Tentrix
- 081 Farrano, Beacon & Narita

10. HEIGHT ADJUSTABLE DESK

- 082 Pallado, Tarea & Virana
- 083 Other

11. WORKSTATION / CONFERENCE ACCESSORIES

- 084 Accessories

12. CONFERENCE / MEETING DESK

- 087 Krest & Java
- 088 Summit & Roxi
- 089 Beacon & Maven
- 090 Mila & Loop
- 091 Nova & Mitra
- 092 Ixia & Smile
- 093 Nistra II & Fuze
- 094 Vista & X-Cross
- 095 Anson, Leto & Orlando
- 096 Karl, SI55 & T22

13. GENERAL WORKSTATION & STORAGE

- | | |
|-----------------------------------|--|
| 097 Verda Series | 132 Hawk Series |
| 100 Maven Series | 133 Nova Series |
| 102 Mitra Series | 134 Snow Series |
| 104 Nova Black Series | 135 Hawk Nova Snow
-Wooden Storage |
| 106 Loop Series | 136 Eazy Series |
| 108 Mila Series | 137 Fs Maple Series |
| 110 Fuze Series | 139 Ziva Series |
| 112 Nistra II Series | 140 Miza Series |
| 114 Ixia Series | 141 Ziva & Miza-Wooden Storage |
| 116 Smile Series | 142 Fs Grey Series |
| 118 Vista Series | 144 Fs Thuja Light Series |
| 120 Mesh Series | 146 Zico Series |
| 121 Uzuo Series | 147 Moro Series |
| 122 Loop-Wooden Storage | 148 Zico & Moro-Wooden Storage |
| 123 Mila-Wooden Storage | 149 Hawk II Series |
| 124 Premier-Wooden Storage | 150 Fo Series |
| 126 Anson Series | 151 Fm Series |
| 127 Leto Series | 152 Fo & Fm-Wooden Storage |
| 128 Fx Series | |
| 130 Flex II Series | |

14. RECEPTION COUNTER

- | | |
|--------------------------------------|---|
| 153 Hydra, Pisces & Stanly | 156 Lesley, Phacelia & Pista |
| 154 Hexa, Shapley & Leo | 157 B-Scot, Exct, Panicum,
Exct-1715, Passiflora & Phalaris |
| 155 Simplicity, Elegant & Jay | |

15. PANEL SYSTEM

- | | |
|---|---|
| 158 Slim Block 40mm THK &
Slim Block 45mm THK | 160 Block 60mm THK |
| 159 Block 54mm THK &
Block 55mm THK & | 161 Tiles 60mm THK &
Tiles 80mm THK |
| | 162 Partition Specification |

16. RACKING SYSTEM

- | | |
|--------------------------------|------------------------------------|
| 163 Light Duty | 165 Gondola Shelving System |
| 164 Medium & Heavy Duty | |

17. STEEL STORAGE

- | | |
|--|---|
| 166 Filing & Lateral Filing Cabinet | 173 Steel Desk & Library Racking |
| 167 Card Record Plan File Cabinet,
Mobile Pedestal & Shoe Rack | 174 Smart Lock, ABS Locker,
Metal Platform Hand Truck &
Glide a Side |
| 168 Full Height & Half Height Cabinet | 175 Mechanical Compactor |
| 169 Wardrobe | 176 Handpush Compactor |
| 170 Single & Half Height Locker | 177 Mobile Compactor |
| 171 Multi Locker | |
| 172 Passport Handphone Locker &
Pigeon Hole | |

18. WOODEN LOCKER

- | |
|----------------------------------|
| 178 Wooden Choice Lockers |
|----------------------------------|

19. PUBLIC & TRAINING SEATING

- | | |
|--|----------------------------------|
| 181 Waiting Bench | 183 Training Room Seating |
| 182 Plastic Fabric Link Chair & Bench | |

20. TRAINING DESK

- | |
|---|
| 184 Acacia, Flick, Flick II & Knox |
|---|

21. CAFE & DINING

- | | |
|--|-----------------------------------|
| 185 Banquet Table & Banquet Chair | 188 Wooden Cushion Chair |
| 186 Design Chair & Fibre Glass Series | 189 Polypropylene Chair |
| 187 High Low Bar Stool | 190 Mix & Match Cafe Table |

22. EDUCATION

- | | |
|--|--|
| 192 Computer Study Table | 195 Classroom Seating |
| 193 Student Chair | 196 Presentation & Display Supplies |
| 194 School Desks & Chair (ABS
High Density Melamine Board) | |

23. REFUSE & RECYCLE BIN

- | |
|--|
| 198 Stainless Steel & Recycle Bin |
|--|

24. AUDITORIUM SEATING

- | |
|--|
| 199 Auditorium Seating,
Hostel Furniture, Lab Furniture &
Cafeteria Folding Table |
|--|

25. ESD / CLEAN ROOM SEATING

- | | |
|-----------------------|---|
| 200 ESD Series | 201 Drafting, Typist Chair & Stool |
|-----------------------|---|

26. FIRE RESISTANT SAFE

- | | |
|------------------------|--|
| 202 Chubb Safes | 203 Ofis Premier & Premier Plus |
|------------------------|--|

27. OUTDOOR FURNITURE / POD / CARREL

- | | |
|---------------------------------------|---------------------------------|
| 204 Designer Outdoor Furniture | 206 Carrel-Office & Home |
| 205 Roof Pod | 207 Carrel-Discussion |

28. OFFICE MACHINE

- | | |
|--|--|
| 208 Shredder | 211 LCD Projector, Electronic
Whiteboard, Franking Machine,
Watchman Clock &
Text Perforator |
| 210 Note-Coin Counter, Laminator
Machine, Cheque Writer,
Comb Binding & Time Attendance | |

ABOUT US

TRUSTED OFFICE FURNITURE SOLUTIONS SINCE 1982

With over 40 years of experience, DSOP Office System & Supplies Sdn. Bhd. has grown to become a trusted name in the office furniture industry. Established in 1982, we are proud to have built a strong reputation for delivering quality, reliability, and exceptional service to businesses of all sizes across Malaysia.

Our comprehensive range includes workstations, executive desks, office seating, storage solutions, boardroom tables, and custom-made furniture tailored to meet the evolving needs of modern workspaces. Whether you're outfitting a corporate office, home office, or co-working space, we offer thoughtfully designed products that combine functionality, comfort, and style.

At DSOP, our commitment goes beyond furniture —we aim to create inspiring work environments that promote productivity and well-being. Backed by decades of industry expertise, a dedicated team, and a passion for excellence, we continue to innovate and support our clients every step of the way.



Strong delivery network and well-established delivery system ensuring timely and secure delivery.



Carefully sourced materials and strict quality control standards to maintain high performance products.



Supportive sales and after-sales team and experienced delivery and installation crew work with care to bring your vision to life.



SPACE PLANNING

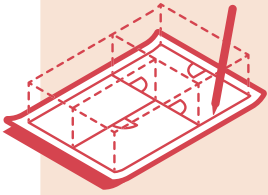

Correct planning ensures you are getting the most out of your workspace. We offer space planning services which utilise the maximum capacity of your workspace safely and efficiently.

Our experienced team uses the latest software to ensure full planning services, from site surveys and 2D plans to walk-through 3D visualisations. Just give us your measurements, and we will create and suggest possible layouts to enhance your existing office space.

2D PLANS

Our 2D plans turn your measurements into a well thought out working area to suit your particular requirements. Once your furniture plan is complete, we can be as detailed as you need and display network points, lighting, power, and anything else you may require. Want to hang on to a few things? Our 2D plans can show a mix of old and new furniture designed by our experienced team.

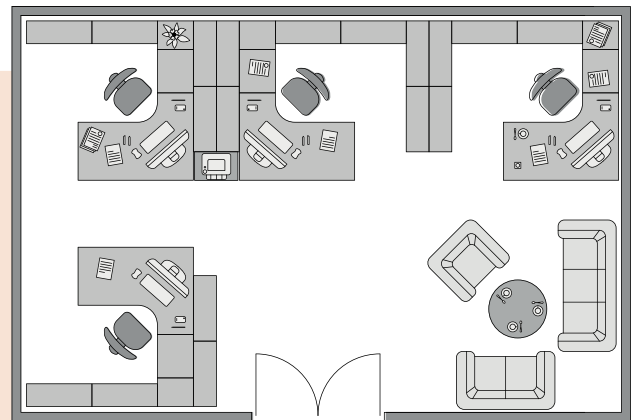

3D PLANS

We can take the 2D plan drawings a stage further by adding carpets and wall finishes, together with colour ideas to suit your corporate identity - or build on your ideas. Once created, we can produce a 3D walk-through visualisation, which enables you to see the result in a clear, concise way.

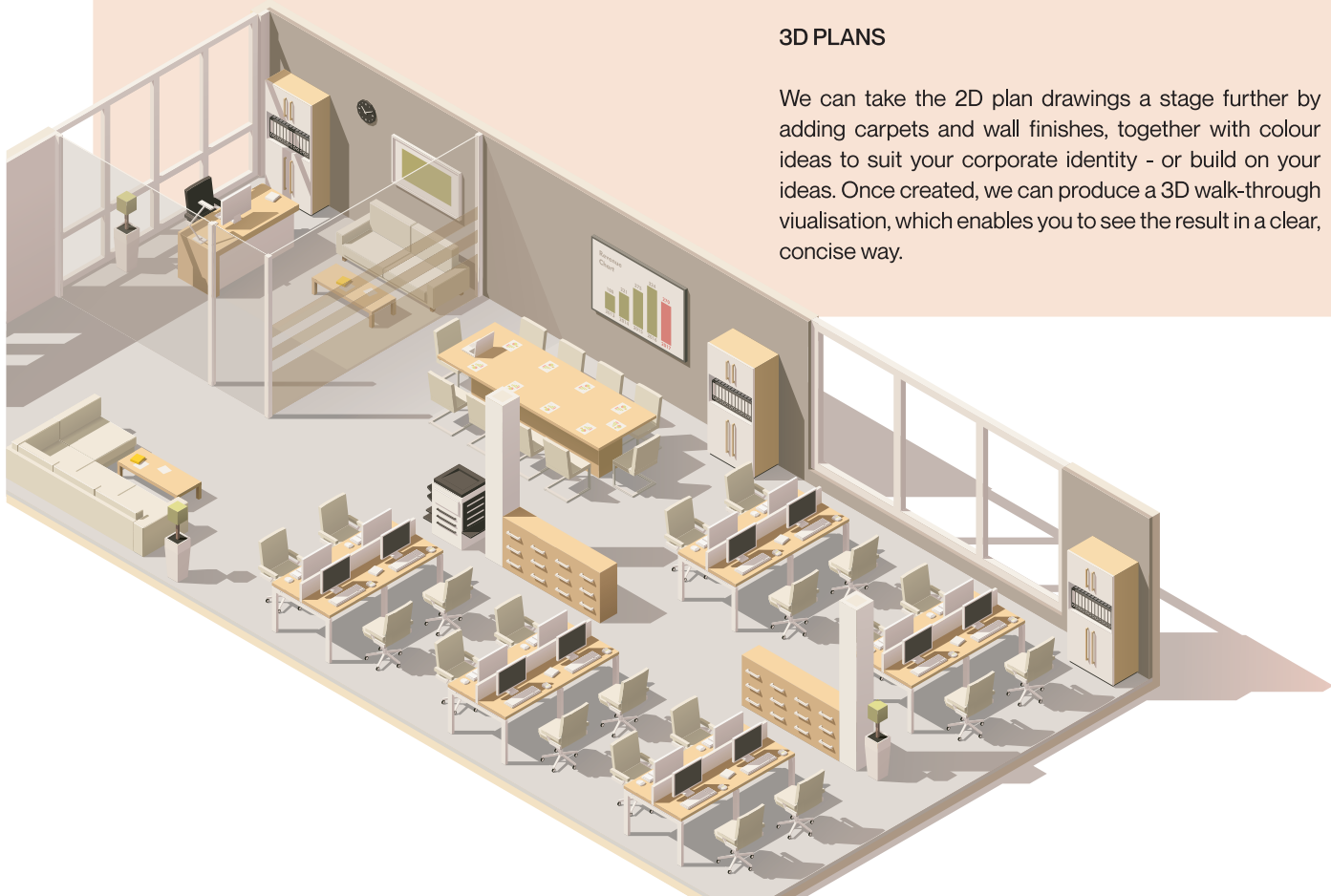

ENJOY

ELITE 2.0

MESH Colour



SEATER Colour



FRAME Colour



Engineered with durability in mind, the chair's sturdy construction ensures long-lasting reliability, supporting you through countless productive days. **ENJOY's** adjustable features allow for personalized comfort, with customizable armrests and a multi-functional tilt mechanism that adapts to your body's needs.



Seat Depth Adjustment



Forward Tilt Adjustment



Backrest Height Adjustment



Tactile Control Identification



RM 2,028



IOO

ELITE 2.0

MESH Colour



SEATER Colour



FRAME Colour



Revolutionize your seating experience with the **IOO's** cutting-edge features. A fully functional and adjustable office chair that promotes dynamic posture and reduces strain. Equipped with 5 Points Smart Motion technology, this chair intuitively responds to your movements as you shift and adjust throughout the day.



5 Points Smart Motion

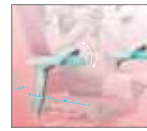

5D Fully Adjustable Armrest

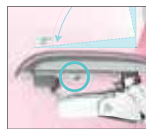

Forward Tilt Adjustment Seat Back & Cushion



Seat Depth Adjustment



RM 2,228



POSH

POSH's full mesh design ensures optimal breathability, keeping you cool and comfortable throughout your workday. Its robust construction gives stability and reliability, providing enduring support for years to come. Embrace a new era of comfort and productivity with POSH.

3D HEADREST DESIGN

The headrest can be tilted, height, forward and backward adjusted to suit the user's individual requirements.

3D ARMREST

Raise, lower, angle and depth adjustments to allow forearms to rest comfortably whilst taking the weight off your shoulders.

LUMBAR SUPPORT HEIGHT ADJUSTMENT

The lumbar support can be positioned for the optimum ergonomic support on user's lumbar at any sitting positions.

BACKREST TILT TENSION ADJUSTMENT

Adjusts angle of back & base proportionally encouraging body movement - increasing blood circulation, therefore reducing fatigue. Additional lock allows you to relax back in one of three positions.

BACKREST TILT TENSION ADJUSTMENT

Adjusts back tension to allow the back to tilt comfortably supporting your body weight when reclining.

SEAT HEIGHT ADJUSTMENT

Raise or lower the seat height on the chair so feet rest flat on the floor allowing the chair to fit individuals of different heights.

SEAT SLIDE ADJUSTMENT

This feature allows you to change the depth of the seat to accommodate the length of the user's legs.



MESH Colour



SEATER Colour



FRAME Colour



High Back Chair
RM 1,988



MESH CHAIR SERIES



Adjustable height headrest

High Back Chair
RM 1,328

Adjustable lumbar support

4D Adjustable Armrest

Self weight Adjustment synchronized mechanism with seat slide (Multi-locking)

High density PU Foam Seat

Aluminium Base with 60mm Nylon Castor

Meet **DUORA**—your perfect work companion. With an adjustable headrest, customizable lumbar support, and a high-density PU foam seat, **DUORA** offers unmatched comfort and support for long hours of productivity.

Types



Medium Back Chair
RM 1,268



DUORA

X-TREME Colour



LANEII & SATELLITE MESH Colour



MALFA

Designed with a solid, supportive headrest and a breathable mesh backrest, **MALFA** ensures optimal comfort and ventilation throughout your workday. Whether you're working, meeting, or brainstorming, the **MALFA** chair combines durability with sleek aesthetics, offering you the perfect balance of support and modern elegance.



Types



MX8111N-18D58
Medium Back Chair
RM 1,478



MX8110N-18D58
High Back Chair
RM 1,558

Adjustable headrest

Adjustable lumbar support

3D Aluminium adjustable armrest with PU pad

Rotary synchronized mechanism (Multi-Locking)

Aluminium base with 60mm nylon castor

X-TREME Colour



LANEII & SATELLITE MESH Colour



ZEDIA

Upgrade your workspace with the perfect combination of comfort, style, and durability. **ZEDIA** offers exceptional support with its ergonomic design, breathable backrest, and adjustable armrests, ensuring all-day comfort for executives and professionals. **ZEDIA** conference chair adds a touch of sophistication to meeting rooms and waiting areas.



Types



ZN8211L-18D36
Presidential Medium Back
RM 938



ZN8213L-89CA
Visitor / Conference chair with arm
RM 798

ZN8210L-18D36
Presidential High Back
RM 999



Adjustable Headrest

2D Adjustable armrest with Polyurethane armpad

Self-weight adjustment synchronized mechanism (3Locks)

Aluminium base with 60mm nylon castor

CARA Colour



LANEII & SATELLITE MESH Colour





Experience ergonomic excellence with **VISION**. Its distinctive backrest design stands out from all the rest and the streamlined, flowing silhouette adds a modern touch to any workspace. Whether you're tackling important tasks or attending virtual meetings, this chair keeps you focused, comfortable, and stylish.

V I S I O N



OF-VISI-H
Highback Chair
RM 468

MESH Colour



SEATER Colour



Types



OF-VISI-M
Medium back Chair
RM 428



MESH CHAIR SERIES



ERA embraces the concept of holistic well-being with its adjustable lumbar support system. The dynamic lumbar adjustment conforms to the natural curve of your spine, providing unparalleled support and promoting healthy posture throughout the day.

E R A



ERA-H
High back Chair
RM 418

MESH Colour



SEATER Colour



Types



ERA-M
Medium back Chair
RM 398

SKYLAR

The adjustable headrest of **SKYLAR** adds another level of personalized comfort. Whether you need extra neck support during intense work sessions or a moment to relax and unwind, the headrest can be easily adjusted to your desired angle, providing optimal support and relieving tension.



MESH Colour



SEATER Colour



Types



SKYLAR-M
Medium Back Chair
RM 438



SKYLAR-H
High Back Chair
RM 458

ZETA

Stay cool and fresh throughout your workday, even during those intense moments of productivity with **ZETA**. The mesh material provides optimal airflow, preventing discomfort and enhancing your overall well-being.



Types



ZETA-H
High Back Chair
RM 538

MESH Colour



SEATER Colour



ZETA-M
Medium Back Chair
RM 438



ZETA-V
Visitor Chair
RM 358

Types



Designed for peak productivity and all-day comfort, **AGATA** features an ergonomic mesh backrest with lumbar support, ensuring perfect posture and breathability. The auto-tension mechanism with a 3-locking system adapts to your movement paired with a high-density foam seat make long hours at the desk feel effortless.

**A
G
A
T
A**



Auto tension mechanism with 3 locking system



STAR 40 FABRIC Colour



SUPER NET Colour (MESH)

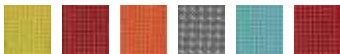

MESH CHAIR SERIES

Types



BARON is an office chair series designed for professionals who demand both style and support. **BARON** offers an ergonomically contoured back mesh that provides targeted lumbar support while keeping you cool throughout long hours.

**B
A
R
O
N**



Imported synchronized mechanism with 1 locking system



STAR 40 FABRIC Colour



SUPER NET Colour (MESH)



LUCE

Resting on a sturdy yet sleek chrome metal base, **LUCE** isn't just a chair—it's a statement of productivity and refined taste. Upgrade your workspace with the luxury you deserve.

Types



OF-LUCE-M
Medium back Chair
RM 588



OF-LUCE-V
Visitor Chair
RM 548

STAR 40 FABRIC Colour



SUPER NET Colour (MESH)

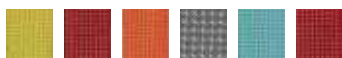

FINORA

Command your workspace with confidence with **FINORA**, a masterpiece of ergonomic innovation and modern aesthetics. Designed for those who lead from their desks, this chair blends lightweight breathability with firm support, thanks to its airy mesh back and contoured frame.

Types



OF-FINORA-M
Medium back Chair
RM 558



OF-FINORA-V
Visitor Chair
RM 518

STAR 40 FABRIC Colour



SUPER NET Colour (MESH)





With its sleek grey netting and pristine white frame, **TRIO** is a true embodiment of modern sophistication. It effortlessly complements any office decor, making a bold statement about your refined taste and attention to detail.

TRIO WHITE



MESH Colour



SEATER Colour



TRIO-H
Highback Chair
RM 438

Types



TRIO-M
Mediumback Chair
RM 398



TRIO-V
Visitor Chair
RM 358



MESH CHAIR SERIES



TRIO's durability and stability are unparalleled. Crafted with high-quality materials and a sturdy frame, it is built to withstand the demands of a busy office environment. Invest in **TRIO**, and you'll enjoy years of reliable support and dependable performance.

TRIO BLACK



MESH Colour



SEATER Colour



TRIO-H
Highback Chair
RM 368

Types



TRIO-M
Mediumback Chair
RM 328



TRIO-V
Visitor Chair
RM 318

R U N A

Break away from ordinary office seating with **RUNA**, a bold fusion of innovation and comfort. Designed to keep up with your dynamic workday, its sculpted frame and ergonomic lumbar support promote natural spinal alignment, ensuring long-lasting comfort.

Types



OF-RUNA-M
Medium back Chair
RM 518



OF-RUNA-V
Visitor Chair
RM 498



STAR 40 FABRIC Colour



SUPER NET Colour (MESH)

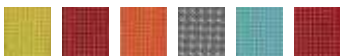

R E X

Step into a seat designed for leaders. The **REX** isn't just about sitting—it's about owning your space. Crafted for all-day support, its breathable mesh back keeps you cool, while the high-density molded foam seat delivers plush comfort.

Types



OF-REX-LB
Low back Chair
RM 518



OF-REX-V
Visitor Chair
RM 478



STAR 40 FABRIC Colour



SUPER NET Colour (MESH)



Anchored by a sturdy polypropylene base, **MARCA** is not just a chair—it's a statement of effortless style and ergonomic excellence. Take a seat, and feel the difference.

MARCA

Types



OF-MARCA-M
Mediumback Chair
RM 418



OF-MARCA-V
Visitor Chair
RM 398



OF-MARCA-H
Highback Chair
RM 438

STAR 40 FABRIC Colour



SUPER NET Colour (MESH)

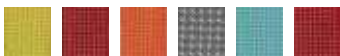

MESH CHAIR SERIES



LUMINO-H
High Back Chair
RM 358

Introducing **LUMINO**, the luminary among mesh office chairs that illuminates your workspace with brilliance. The sleek lines and contemporary silhouette effortlessly elevate the ambiance of your workspace.

Types



LUMINO-M
Medium Back Chair
RM 248



LUMINO-V
Visitor Chair
RM 228

MESH Colour



SEATER Colour



LUMINO

PIXIE

PIXIE's innovative design transcends the ordinary. Its sleek and contemporary aesthetic adds a touch of elegance to any office environment, captivating attention and inspiring awe. Elevate your workspace with the allure of **PIXIE**.

Types



PIXIE-M
Medium Back Chair
RM 328



PIXIE-V
Visitor Chair
RM 228



PIXIE-H
High Back Chair
RM 358

SEATER Colour



MESH Colour



ASSA

SEATER Colour



MESH Colour



High Back Chair
RM 498

2D adjustable armrest

Fixed lumbar support

Nylon Rocket Base

ALDA

SEATER Colour



MESH Colour



High Back Chair
RM 698

2D adjustable armrest

Adjustable lumbar support

Chrome leg

CIRO

SEATER Colour



MESH Colour



High Back Chair
RM 598

Fixed armrest

Fixed lumbar support

Chrome leg

S P O T



Lowback Chair
RM 398



MESH Colour



SEATER Colour



MESH CHAIR SERIES

E N Z A



Lowback Chair
RM 268



MESH Colour



SEATER Colour



S Y L P H Y



Lowback Chair
RM 288

STAR 40 FABRIC Colour



SUPER NET Colour



E L O R A

MESH Colour



SEATER Colour



O R I O N

MESH Colour

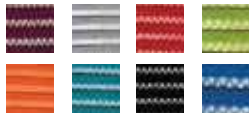

SEATER Colour



N O V U S

MESH Colour



SEATER Colour



M E Z E

SUPERNET Colour

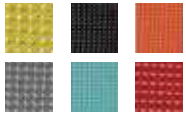

GALAXY SEATER Colour

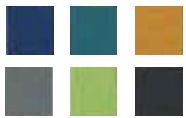

Low Back Chair
RM 268



MESH CHAIR SERIES

SUPERNET Colour

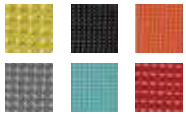

GALAXY SEATER Colour



Low Back Chair
RM 248

Visitor Chair
RM 238

E C O

MESH Colour



SEATER Colour



Low Back Chair
RM 198

Visitor Chair
RM 195

G L O

SURFACE



SFLS 8401N - D34
Presidential High back
Adjustable Armrest

RM 648



SFLS 8410N - D34
Presidential High back
Adjustable Armrest

RM 648



SFLS 8411N - D34
Presidential Medium back
Adjustable Armrest

RM 578



Adjustable Armrest
Fixed Armrest



SFLS 8401N - A60
Presidential High back
Fixed Armrest

RM 608



SFLS 8410N - A60
Presidential High back
Fixed Armrest

RM 608



SFLS 8411N - A60
Presidential Medium back
Fixed Armrest

RM 538

ZENITH



ZNLS 8210N - D36
Presidential High back
Adjustable Armrest

RM 648



ZNLS 8211N - D36
Presidential Medium back
Adjustable Armrest

RM 578



Adjustable Armrest



Fixed Armrest



ZNLS 8210N - A62
Presidential High back
Fixed Armrest

RM 608



ZNLS 8211N - A62
Presidential Medium back
Fixed Armrest

RM 538

ICON



ICLS 8910N - D36
Presidential High back
Adjustable Armrest

RM 658



ICLS 8911N - D36
Presidential Medium back
Adjustable Armrest

RM 588



Adjustable Armrest



Fixed Armrest



ICLS 8910N - A62
Presidential High back
Fixed Armrest

RM 618



ICLS 8911N - A62
Presidential Medium back
Fixed Armrest

RM 548

OTIS



OTLS 8810N - D95
Presidential High back
Adjustable Armrest

RM 688



OTLS 8811N - D95
Presidential Medium back
Adjustable Armrest

RM 618



Slide Armrest



Fixed Armrest



OTLS 8810N - A75
Presidential High back
Fixed Armrest

RM 658



OTLS 8811N - A75
Presidential Medium back
Fixed Armrest

RM 588

PMESH



PSLS 8712N - D34
Executive Low back
Adjustable Armrest

RM 528



PSLS 8712N - A60
Executive Low back
Fixed Armrest

RM 488



Adjustable Armrest



Fixed Armrest

MESH Colour



X-TREME Colour



ALTIMO SERIES



- OF-AT-001-HB **RM 538**
High Back Chair
- OF-AT-002-LB **RM 508**
Low Back Chair
- OF-AT-003-VA **RM 498**
Visitor Chair

HORIZON SERIES



- OF-HOR-001-HB **RM 438**
High Back Chair
- OF-HOR-002-LB **RM 428**
Low Back Chair
- OF-HOR-003-VA **RM 408**
Visitor Chair

PARAGON SERIES



- OF-PAR-001-HB **RM 498**
High Back Chair
- OF-PAR-002-LB **RM 468**
Low Back Chair
- OF-PAR-003-VA **RM 438**
Visitor Chair

FLAMINGO SERIES



- OF-FG-001-HB **RM 358**
High Back Chair
- OF-FG-002-LB **RM 338**
Low Back Chair
- OF-FG-003-VA **RM 328**
Visitor Chair

YOGO SERIES



- OF-YG-001-HB **RM 358**
High Back Chair
- OF-YG-002-LB **RM 338**
Low Back Chair
- OF-YG-003-VA **RM 328**
Visitor Chair

DOLPHIN SERIES



- OF-DOL-001-HB **RM 398**
High Back Chair
- OF-DOL-002-LB **RM 388**
Low Back Chair
- OF-DOL-003-VA **RM 368**
Visitor Chair

VERTIC SERIES



- OF-VER-001-HB **RM 448**
High Back Chair
- OF-VER-002-LB **RM 418**
Low Back Chair
- OF-VER-003-VA **RM 388**
Visitor Chair

MAETIS SERIES



- OF-MAE-001-HB **RM 338**
High Back Chair
- OF-MAE-002-LB **RM 318**
Low Back Chair
- OF-MAE-003-VA **RM 318**
Visitor Chair

MAXI SERIES



- OF-MAXI-001-HB **RM 488**
High Back Chair
- OF-MAXI-002-LB **RM 458**
Low Back Chair
- OF-MAXI-003-VA **RM 418**
Visitor Chair

TIVOLI SERIES



- OF-TIV-001-HB **RM 338**
High Back Chair
- OF-TIV-002-LB **RM 318**
Low Back Chair
- OF-TIV-003-VA **RM 318**
Visitor Chair

MICK SERIES



- OF-MK-001-HB **RM 328**
High Back Chair
- OF-MK-002-LB **RM 308**
Low Back Chair
- OF-MK-003-VA **RM 308**
Visitor Chair

CURVE SERIES



- OF-CUR-001-HB **RM 608**
High Back Chair
- OF-CUR-002-LB **RM 578**
Low Back Chair
- OF-CUR-003-VA **RM 548**
Visitor Chair

BRUGAL SERIES



- OF-BRU-001-HB **RM 548**
High Back Chair
- OF-BRU-002-LB **RM 518**
Low Back Chair
- OF-BRU-003-VA **RM 488**
Visitor Chair

FERGO SERIES



- OF-FER-001-HB **RM 648**
High Back Chair
- OF-FER-002-LB **RM 608**
Low Back Chair
- OF-FER-003-VA **RM 498**
Visitor Chair

COVA SERIES



- OF-COVA-001-HB **RM 658**
High Back Chair
- OF-COVA-002-LB **RM 608**
Low Back Chair
- OF-COVA-003-VA **RM 498**
Visitor Chair

LENNY SERIES



- OF-HB-LY-A4H2B3-M **RM 468**
High Back Chair
- OF-LB-LY-A4H2B3-M **RM 438**
Low Back Chair
- OF-VB-LY-A4F2-M **RM 378**
Visitor Chair

SUPERNET Colour:



STAR 40 COLLECTION Colour:



BLOOM

Step into an era of refined aesthetics with the **BLOOM** series. Its classic design, adorned with button studs on the backrest and armrest, adds a touch of vintage charm to your workspace. Sink into the generously padded seat and backrest, allowing the stresses of the day to melt away.



Type (Variations)

PU : PU LEATHER
HL : HALF LEATHER
FL : FULL LEATHER



OF-BLO-LB-H3B4-P
Low Back Chair
PU : RM 1,358
HL : RM 2,128
FL : RM 2,798



OF-BLO-VB-F1-P
Visitor Chair
PU : RM 1,178
HL : RM 2,038
FL : RM 2,538



OF-BLO-HB-H3B4-P
High Back Chair
PU : RM 1,458
HL : RM 2,218
FL : RM 2,928

Height adjustable with lever and backrest counter pressure adjustment and knee tilt mechanism

Comfortable

Polished aluminium die-casting 5 prong base

TUSCANY PU Colour



NATURA Colour



ARES

Make a bold statement with the **ARES** Series, a chair that embodies sophistication and authority. Upholstered in plush, high-density foam with a refined button-tufted design, it exudes timeless charm while ensuring supreme comfort.



Type (Variations)

PU : PU LEATHER
HL : HALF LEATHER
FL : FULL LEATHER



OF-ARES-M
Medium Back Chair
PU : RM 1,248
HL : RM 1,788
FL : RM 2,058



OF-ARES-V
Visitor Chair
PU : RM 918
HL : RM 1,498
FL : RM 1,688

OF-ARES-H
High Back Chair
PU : RM 1,258
HL : RM 1,878
FL : RM 2,158

Rubber wood wooden armrest with upholstery armpad

High density moulded injected foam

Imported knee-tilt mechanism with 5 position locking system

Rubber wood wooden base with metal

MORIPU Colour



VACALEATHER Colour





Sink into its plush cushioning and enjoy the ergonomic design that promotes proper posture. With a high backrest and adjustable features, including height and tilt, you can customize the chair to fit your preferences, ensuring optimal comfort throughout the day.

JANEIRO

Type (Variations)



OF-JAN-LB-A5H3B4-P

Low Back Chair
PU: RM 1,268
HL: RM 1,948
FL: RM 2,358

PU: PU LEATHER
 HL: HALF LEATHER
 FL: FULL LEATHER



OF-JAN-VB-A5F20-P

Visitor Chair
PU: RM 1,148
HL: RM 1,888
FL: RM 2,268

OF-JAN-HB-A5H3B4-P

High Back Chair
PU: RM 1,358
HL: RM 2,108
FL: RM 2,558



TUSCANY PU Colour



NATURA Colour



PU LEATHER CHAIR SERIES

Type (Variations)



Don't settle for ordinary office chairs. Treat yourself to the ultimate in comfort with the **SANTIAGO** High Back Chair and transform your workspace into a haven of relaxation and productivity. Experience the difference today.

SANTIAGO



OF-SAN-LB-A5H3B4-P

Low Back Chair
PU: RM 1,268
HL: RM 1,948
FL: RM 2,358

PU: PU LEATHER
 HL: HALF LEATHER
 FL: FULL LEATHER



OF-SAN-VB-A5F20-P

Visitor Chair
PU: RM 1,148
HL: RM 1,888
FL: RM 2,268

OF-SAN-HB-A5H3B4-P

High Back Chair
PU: RM 1,358
HL: RM 2,108
FL: RM 2,558



TUSCANY PU Colour



NATURA Colour



L A G E N D E R

Redefine your workspace with **LAGENDER**, the series for those who seek luxury, support, durability. The plush headrest, upholstered aluminium armrests, and knee-tilt mechanism with multiple locking positions provide the perfect blend of relaxation and professionalism.



Type (Variations)



OF-LAGENDER-M
Medium Back Chair

PU : RM 938
HL : RM 1,668
FL : RM 1,838



OF-LAGENDER-V
Visitor Chair

PU : RM 828
HL : RM 1,418
FL : RM 1,578

PU : PU LEATHER
HL : HALF LEATHER
FL : FULL LEATHER



OF-LAGENDER-H
High Back Chair

PU : RM 968
HL : RM 1,768
FL : RM 1,928

MORIPU Colour



VACALEATHER Colour



M I R E Z Z A

For those who appreciate contemporary aesthetics and superior comfort, **MIREZZA** delivers. Its streamlined silhouette, aluminium armrests, and "Rocket" aluminium base create a striking, modern look.



Type (Variations)



OF-MIREZZA-M
Medium Back Chair

PU : RM 1,028
HL : RM 1,758
FL : RM 1,928



OF-MIREZZA-V
Visitor Chair

PU : RM 948
HL : RM 1,598
FL : RM 1,758

PU : PU LEATHER
HL : HALF LEATHER
FL : FULL LEATHER



OF-MIREZZA-H
High Back Chair

PU : RM 1,058
HL : RM 1,928
FL : RM 2,058

MORIPU Colour



VACALEATHER Colour





Imagine sitting in a chair that moulds to your body, providing unparalleled support and comfort throughout the day. **LAPAZ** is engineered with advanced ergonomic features that conform to your body's natural contours, ensuring optimal posture and reducing the strain on your back and neck.

LAPAZ

Type (Variations)



OF-LAP-LB-A7H7B6-P

Low Back Chair
PU : RM 928
HL : RM 1,558
FL : RM 1,878



OF-LAP-VB-A7H7B6-P

Visitor Chair
PU : RM 798
HL : RM 1,458
FL : RM 1,768

OF-LAP-HB-A7H7B6-P

High back Chair
PU : RM 999
HL : RM 1,628
FL : RM 2,018



PU : PU LEATHER
HL : HALF LEATHER
FL : FULL LEATHER

TUSCANY PU Colour



NATURA Colour



PU LEATHER CHAIR

SERIES

Type (Variations)



BOGOTA Series — a chair designed not just to support you but to elevate your presence. Wrapped in meticulously stitched premium PU leather, this high-back masterpiece offers more than just seating; it's an experience of prestige.

BOGOTA



OF-BOG-LB-A7H7B6-P

Low Back Chair
PU : RM 928
HL : RM 1,558
FL : RM 1,878



OF-BOG-VA-A7F1-P

Visitor Chair
PU : RM 798
HL : RM 1,458
FL : RM 1,768

OF-BOG-HB-A7H7B6-P

High back Chair
PU : RM 999
HL : RM 1,628
FL : RM 2,018



PU : PU LEATHER
HL : HALF LEATHER
FL : FULL LEATHER

TUSCANY PU Colour



NATURA Colour



SPINA

Engineered for those who refuse to settle, this chair is more than just a seat—it's a daily experience of comfort and precision. Whether you're conquering deadlines or diving into deep focus, the **SPINA** makes every moment at your desk feel seamless and inspired.



Type (Variations)



OF-SPINA-M
Medium Back Chair

PU : RM 918
HL : RM 1,578
FL : RM 1,758



OF-SPINA-V
Visitor Chair

PU : RM 828
HL : RM 1,418
FL : RM 1,578

PU : PU LEATHER
HL : HALF LEATHER
FL : FULL LEATHER

OF-SPINA-H
High Back Chair

PU : RM 938
HL : RM 1,758
FL : RM 1,928



MORIPU Colour



VACALEATHER Colour



FULGO

The **FULGO** Series is the perfect harmony of modern elegance and ergonomic innovation. The high-density moulded foam ensures all-day comfort, while the synchronized mechanism with a five-position locking system adapts effortlessly to your posture.



Type (Variations)



OF-FULGO-M
Medium Back Chair

PU : RM 948
HL : RM 1,578
FL : RM 1,758



OF-FULGO-V
Visitor Chair

PU : RM 838
HL : RM 1,418
FL : RM 1,578

PU : PU LEATHER
HL : HALF LEATHER
FL : FULL LEATHER

OF-FULGO-H
High Back Chair

PU : RM 968
HL : RM 1,758
FL : RM 1,918



MORIPU Colour



VACALEATHER Colour





Invest in a chair that offers both style and substance. The **KADOS** Series, made with luxurious PU leather, is a symbol of refinement and durability. The smooth and supple PU leather upholstery wraps around you, offering a touch of opulence that adds elegance to any office setting.

K A D O S

Type (Variations)



OF-KAD-LB-A7H7B6-P

Low Back Chair
PU : RM 928
HL : RM 1,558
FL : RM 1,878



OF-KAD-VB-A7F1-P

Visitor Chair
PU : RM 798
HL : RM 1,458
FL : RM 1,768

PU : PU LEATHER
HL : HALF LEATHER
FL : FULL LEATHER

OF-KAD-HB-A7H7B6-P

High Back Chair
PU : RM 999
HL : RM 1,628
FL : RM 2,018



Enhanced quality upholstery & fine stitching workmanship

Chrome with soft PU padded armrest

Polished aluminium die-casting 5 prong base

Multi locking position & height adjustment for better seating posture

TUSCANY PU Colour



NATURA Colour



PU LEATHER CHAIR SERIES

Type (Variations)



The moment you lay eyes on the **CRON**, you recognize power, elegance, and comfort in one seamless design. Whether you're leading a meeting or diving into deep focus, this chair commands attention—and keeps you at the top of your game.

C R O N



OF-CRO-LB-A7H7HB6-P

Low Back Chair
PU : RM 928
HL : RM 1,558
FL : RM 1,878



OF-CRO-VB-A7F1-P

Visitor Chair
PU : RM 798
HL : RM 1,458
FL : RM 1,768

PU : PU LEATHER
HL : HALF LEATHER
FL : FULL LEATHER

OF-CRO-HB-A7H7B6-P

High Back Chair
PU : RM 999
HL : RM 1,628
FL : RM 2,018



Chrome with soft PU padded armrest

Multi-locking position & height adjustment for better seating position

Polished aluminium die-casting epoxy base

TUSCANY PU Colour



NATURA Colour



KENO

Experience unparalleled comfort and style with **KENO**. The intricate button back design adds a touch of timeless charm. As you settle into its plush embrace, the supple leather cradles your body while the buttons create a visual symphony of style.

Type (Variations)



OF-KEN-LB-A5H3B6-P
Medium Back Chair

PU : RM 1,138
HL : RM 1,918
FL : RM 2,328



OF-KEN-VB-A5H3B6-P
Visitor Chair

PU : RM 1,068
HL : RM 1,848
FL : RM 2,098

TUSCANY PU Colour



NATURA Colour



OF-KEN-HB-A5H3B6-P
High Back Chair

PU : RM 1,158
HL : RM 2,088
FL : RM 2,508



CUSEO

Indulge in the opulence of the **CUSEO** series, designed with the finest PU leather upholstery. The sleek and supple material not only exudes sophistication but also offers exceptional durability.

Type (Variations)



OF-CUS-LB-A7H7B6-P
Low Back Chair

PU : RM 928
HL : RM 1,558
FL : RM 1,878



OF-CUS-VB-A7F1-P
Visitor Chair

PU : RM 798
HL : RM 1,458
FL : RM 1,768

TUSCANY PU Colour



NATURA Colour



OF-CUS-HB-A7H7B6-P
High Back Chair

PU : RM 999
HL : RM 1,628
FL : RM 2,018





The **NATAL** Office Chair Series is a testament to fine stitching workmanship. Every stitch is meticulously crafted, showcasing attention to detail and precision. The seamless stitching adds a touch of elegance, elevating the overall aesthetics of the chair and making it a stylish addition to any office environment.

NATAL

Type (Variations)



OF-NAT-LB-A7H7B6-P

Low Back Chair
PU : RM 928
HL : RM 1,558
FL : RM 1,878



OF-NAT-VB-A7F1-P

Visitor Chair
PU : RM 798
HL : RM 1,458
FL : RM 1,768



Enhanced upholstery & fine stitching workmanship

Chrome with soft PU padded armrest

Polished aluminium die-casting 5 prong base

Multi locking position & height adjustment for better seating posture

OF-NAT-HB-A7H7B6-P

High Back Chair
PU : RM 999
HL : RM 1,628
FL : RM 2,018

TUSCANY PU Colour



NATURA Colour



PU LEATHER CHAIR SERIES



Type (Variations)

The **FOLIA** is your perfect blend of luxury and performance—because success starts with how you sit. The aluminium armrests with plush **PU** padding provide a refined touch, ensuring support during long hours.

FOLIA



OF-FOLIA-M

Medium Chair
PU : RM 1,018
HL : RM 1,838
FL : RM 1,998



OF-FOLIA-V

Visitor Chair
PU : RM 908
HL : RM 1,588
FL : RM 1,758

OF-FOLIA-H

High back Chair
PU : RM 1,048
HL : RM 1,998
FL : RM 2,158

PU : PU LEATHER
 HL : HALF LEATHER
 FL : FULL LEATHER

Aluminium armrest with PU armpad

Aluminium die-cast base

Imported synchronized mechanism with 5 position locking system

MORIPU Colour



VACALEATHER Colour



AION

One of the standout features of the **AION** series is its luxurious chrome armrests. These armrests not only provide a stylish accent to the chair's design but also offer a comfortable and supportive resting place for your arms. Its PU leather upholstery, complemented by luxurious chrome armrests, creates a captivating visual appeal.



Type (Variations)



PRE20C-LB
Low Back Chair
PU : RM 1,148
HL : RM 1,738
FL : RM 2,038



PRE21C-SE
Visitor Chair
PU : RM 1,048
HL : RM 1,638
FL : RM 1,938

ZETA PU Colour



VACALEATHER Colour



PU : PU LEATHER
HL : HALF LEATHER
FL : FULL LEATHER



PRE19C-HB
High Back Chair
PU : RM 1,168
HL : RM 1,758
FL : RM 2,058

TYPHON

Durability and quality are at the core of the **TYPHON** Office Chair Series. Constructed with premium materials and fine craftsmanship, these chairs are built to withstand the demands of a modern office environment. Say goodbye to strained muscles and hello to a more relaxed and focused workday.



Type (Variations)



PRE93-LB
Low Back Chair
PU : RM 958
HL : RM 1,588
FL : RM 1,918



PRE95-SE
Visitor Chair
PU : RM 938
HL : RM 1,568
FL : RM 1,908

ZETA PU Colour



VACALEATHER Colour



PU : PU LEATHER
HL : HALF LEATHER
FL : FULL LEATHER



PRE92-HB
High Back Chair
PU : RM 978
HL : RM 1,618
FL : RM 1,938



ZAFFA is not just a chair, it's a dynamic tool that adapts to your needs, empowering you to conquer challenges with ease. Immerse yourself in the perfect balance of comfort and cutting-edge technology.

Z A F F A

Type (Variations)



ZY5211L-13S50
Medium back Chair
PU : RM 808
HL : RM 1,478
FL : RM 1,728

PU : PU LEATHER
HL : HALF LEATHER
FL : FULL LEATHER



ZY5213L-89CA
Visitor Chair
PU : RM 648
HL : RM 1,318
FL : RM 1,538



ZY5212L-13S50
Low back Chair
PU : RM 798
HL : RM 1,428
FL : RM 1,668

Chrome armrest with upholstery armpad.

ZY5210L-13S50
High back Chair
PU : RM 828
HL : RM 1,528
FL : RM 1,788

Swivel knee tilt synchronized mechanism with multi tilting lock system & tilt at 30° reclining position.

High density Polyurethane moulded foam.



Die-cast aluminium polished base that comes with matching 60mm nylon dual-wheel castors.

SYNTHETIC PU Colour



GENUINE LEATHER Colour



PU LEATHER CHAIR SERIES

Type (Variations)



Each chair combines a clean, minimalistic design with practical functionality. The **KASTEL** series offers a range of seating solutions that are perfect for any office environment.

K A S T E L



KL5611L-13S58
Medium back Chair
PU : RM 688
HL : RM 1,348
FL : RM 1,578

PU : PU LEATHER
HL : HALF LEATHER
FL : FULL LEATHER



KL5613L-90CS58
Visitor Chair c/w Arm
PU : RM 568
HL : RM 1,228
FL : RM 1,428



KL5612L-13S58
Low back Chair
PU : RM 678
HL : RM 1,308
FL : RM 1,528

KL5610L-13S58
High back Chair
PU : RM 698
HL : RM 1,398
FL : RM 1,628

Die-cast polished finish fixed aluminium armrest with upholstery armpad is designed for its visual aesthetics, durability & reliability. The top upholstery armpad provides soft texture for a more comfortable resting elbows.

Die-cast aluminium polished finish comes with 60mm nylon dual-wheel castors.

Swivel knee tilt mechanism with multi tilting lock system & tilt at 30° reclining position, allows tilting of backrest & seating in same angle, also allows angle locker to help user to control over tilting angles for desired working postures.



SYNTHETIC PU Colour



GENUINE LEATHER Colour



ELINI

The ideal balance between support and flexibility. **ELINI** brings harmony to your workspace, combining sleek aesthetics with ergonomic design. Upgrade to **ELINI** today and unlock a new level of productivity and satisfaction in your office.



Type (Variations)



ER5511L-10D36
Medium Back Chair
PU : RM 648
HL : RM 1,328



ER5512L-10D36
Low Back Chair
PU : RM 638
HL : RM 1,278



ER5513L-89CA
Visitor Chair c/w Arm
PU : RM 578
HL : RM 1,238



ER5514L-92C
Visitor Chair w/o Arm
PU : RM 508
HL : RM 1,198

PU : PU LEATHER
HL : HALF LEATHER

ER5510L-10D36
High Back Chair
PU : RM 728
HL : RM 1,418



SYNTHETIC PU Colour



GENUINE LEATHER Colour



SILO

Each chair boasts fine stitching workmanship, showcasing the artistry that went into its creation. Meticulously crafted with exquisite stitching workmanship, **SILLO** office chairs are a testament to timeless elegance. The attention to detail is evident in every seam, promising durability and elegance that lasts.



Type (Variations)



OF-SL-LB-A3H1B1-P
Low Back Chair
PU : RM 578
HL : RM 1,428
FL : RM 1,638



OF-SL-VB-A3F3-P
Visitor Chair
PU : RM 538
HL : RM 1,348
FL : RM 1,628

PU : PU LEATHER
HL : HALF LEATHER
FL : FULL LEATHER



TUSCANY PU Colour



NATURA Colour





Crafted with precision and finesse, the high-back design exudes an aura of executive authority. With rotary point synchronization seamlessly adapting to your movements, every aspect of the **SMARTY** series is engineered to enhance comfort and efficiency.

SMARTY

Type (Variations)



SM6511L-13A78
Medium back Chair

PU : RM 838
HL : RM 1,588
FL : RM 1,858



SM6511L-21A78
Visitor Chair

PU : RM 768
HL : RM 1,518
FL : RM 1,778



SM6512L-13A78
Low back Chair

PU : RM 828
HL : RM 1,558
FL : RM 1,808

SM6510L-13A78
High Back Chair

PU : RM 858
HL : RM 1,628
FL : RM 1,908

Fixed Armrest - Sleek curved armrest that provide a solid support.

Moulded PU Foam - Fire-retardant high density polyurethane foam offers lasting comfort during extended use.

5 Pronged Base - Pronged base in either die-cast aluminum or nylon finish.

Excellent Mechanism - Durable and tough build ensure years of comfort and reliable use.



SYNTHETIC PU Colour



GENUINE LEATHER Colour



PU LEATHER CHAIR SERIES

FOLIO



DA-HB-ND-P
High Back Chair

PU : RM 999
HL : RM 1,648
FL : RM 2,188

Steel sheet armrest comes with 5 high density cushion armpad.

High density injection foam.

Aluminium base.



TUSCANY PU Colour



NATURA Colour



PU Colour



Designed to support you like no other, **PRIME** features a unique segmented backrest with adjustable lumbar support, ensuring your spine stays perfectly aligned throughout the day. Elevate your office with a chair that's not just different—it's designed for all-day comfort.

PRIME



HIGH BACK CHAIR

RM 798

BRUNO

BRUNO's plush padding allows your body to relax and alleviate any tension. Whether you prefer to sit higher for increased focus or lower for a relaxed posture, this chair adapts to you effortlessly. Its sleek design, coupled with the premium PU leather upholstery, adds a touch of elegance to any office or study area.

PU Colour



HIGH BACK CHAIR

RM 738

PU Colour



It is upholstered with premium PU leather, providing a luxurious feel while ensuring durability and easy maintenance. The smooth texture of the leather adds a touch of sophistication to any office environment. Comfort is paramount when it comes to long hours of sitting, and the RICCO chair delivers.

RICCO



HIGH BACK CHAIR

RM 698



PU LEATHER CHAIR SERIES

BEYOND

The BEYOND chair is a bold statement in executive comfort. Ideal for managers, directors, and those who value presence in their workspace, BEYOND is a true centerpiece of modern executive seating.

PU Colour



HIGH BACK CHAIR

RM 688

PU Colour



Indulge in executive-level comfort with SAVINO. Designed for those who demand both luxury and support, this chair features plush, thick cushioning that envelops you in comfort from the moment you sit down.

SAVINO



HIGH BACK CHAIR

RM 798

PU LEATHER CHAIR SERIES



OF-091H
High Back Chair
RM 1,538



OF-092H
Low Back Chair
RM 1,468



OF-093S
Visitor Chair
RM 1,308



OF-081H
High Back Chair
RM 1,308



OF-082H
Low Back Chair
RM 1,248



OF-083H
Visitor Chair
RM 1,128



OF-095H
High Back Chair
RM 1,308



OF-096H
Low Back Chair
RM 1,268



OF-097S
Visitor Chair
RM 1,168



OF-065H
High Back Chair
RM 1,148



OF-066H
Low Back Chair
RM 1,118



OF-067S
Visitor Chair
RM 998



OF-121H
High Back Chair
RM 1,208



OF-122H
Low Back Chair
RM 1,168



OF-123H
Visitor Chair
RM 1,068



OF-085H
High Back Chair
RM 1,538



OF-086H
Low Back Chair
RM 1,468



OF-087S
Visitor Chair
RM 1,318



OF-075H
High Back Chair
RM 1,148



OF-076H
Low Back Chair
RM 1,118



OF-077S
Visitor Chair
RM 998



OF-071H
High Back Chair
RM 1,288



OF-072H
Low Back Chair
RM 1,248



OF-073S
Visitor Chair
RM 1,128



OF-061H
High Back Chair
RM 1,268



OF-062H
Low Back Chair
RM 1,238



OF-063S
Visitor Chair
RM 1,078



OF-111H
High Back Chair
RM 1,080



OF-112H
Low Back Chair
RM 1,038



OF-113S
Visitor Chair
RM 938

MORIColour



PU LEATHER CHAIR SERIES



COMO SERIES [PU]



- CV6110L-10D98** **RM 1,038**
High Back Chair
- CV6111L-10D98** **RM 948**
Low Back Chair
- CV6113L-19D98** **RM 918**
Visitor Chair

ASTI SERIES [PU]



- AR5310L-10D91** **RM 768**
High Back Chair
- AR5311L-10D91** **RM 758**
Low Back Chair
- AR5314L-92C** **RM 658**
Visitor Chair

KLAUS SERIES [PU]



- KR5410L-10D90** **RM 768**
High Back Chair
- KR5411L-10D90** **RM 758**
Low Back Chair
- KR5414L-92C** **RM 658**
Visitor Chair

PETINA SERIES [PU]



- PG5110L-10D90** **RM 898**
High Back Chair
- PG5111L-10D90** **RM 888**
Low Back Chair
- PG5113L-89CA** **RM 688**
Visitor Chair

Synthetic PU Colour



AETHER SERIES



- PRE13N** **RM 1,028**
High Back Chair
- PRE14N** **RM 998**
Low Back Chair
- PRE15N** **RM 958**
Visitor Chair

DAMON SERIES



- PRE66** **RM 1,258**
High Back Chair
- PRE67** **RM 1,238**
Low Back Chair
- PRE68-SE** **RM 1,128**
Visitor Chair

HYBRIS SERIES



- PRE72** **RM 1,128**
High Back Chair
- PRE73-N** **RM 1,078**
Low Back Chair
- PRE75-SE** **RM 1,018**
Visitor Chair

OUREA SERIES



- PRE16N** **RM 998**
High Back Chair
- PRE17N** **RM 978**
Low Back Chair
- PRE18N** **RM 938**
Visitor Chair

ZETA PU Colour



SUPERIOR SERIES



- E1091H** **RM 1,028**
High Back Chair
- E1093H** **RM 1,008**
Low Back Chair
- E1094S** **RM 838**
Visitor Chair

TECH SERIES



- E718H** **RM 1,028**
High Back Chair
- E738H** **RM 1,008**
Low Back Chair
- E748S** **RM 838**
Visitor Chair

SHADE SERIES



- E91H** **RM 688**
High Back Chair
- E93H** **RM 678**
Low Back Chair
- E94S** **RM 668**
Visitor Chair

MORO SERIES



- E2081H** **RM 1,058**
High Back Chair
- E2083H** **RM 1,038**
Low Back Chair
- E2084S** **RM 798**
Visitor Chair

TIER SERIES



- E2861H** **RM 918**
High Back Chair
- E2863H** **RM 908**
Low Back Chair
- E2864S** **RM 758**
Visitor Chair

VITO SERIES



- E2071H** **RM 938**
High Back Chair
- E2073H** **RM 918**
Low Back Chair
- E2074S** **RM 798**
Visitor Chair

CANDY SERIES



- E3151H** **RM 868**
High Back Chair
- E3153H** **RM 848**
Low Back Chair
- E3154S** **RM 698**
Visitor Chair

MISTRAL SERIES



- E3095H** **RM 718**
High Back Chair
- E3096H** **RM 698**
Low Back Chair
- E3097S** **RM 678**
Visitor Chair

MORI Colour





Experience the perfect fusion of comfort, style, and functionality with the **ENNA** Series, where innovation meets sophistication to redefine your workday experience.

ENNA

Type (Variations)



FT6411F-13A77
Medium Back Chair
RM 968



EV6413F-92E
Visitor Chair
RM 588



EV6412F-13A77
Low Back Chair
RM 958

EV6410F-13A77
High Back Chair
RM 989

PU moulded foam is attached to the bottom Polypropylene cover.

Self-weight adjustment synchronized mechanism with 3 tensions level adjustable knob & multi-locking system.

Fixed armrest.

5 pronged base in die-cast polished aluminium finish to provide strong stability.



X-TREME Colour



CARA Colour



FABRIC CHAIR SERIES

Type (Variations)



Whether you're tackling deadlines or collaborating in meetings, the **ELINI** Series ensures you stay focused and comfortable throughout the day. Choose **ELINI** as your ultimate ergonomic solution for the modern workspace.

ELINI



ER5511L-30A60
Medium Back Chair
RM 528



ER5512F-30A60
Low Back Chair
RM 518



ER5513F-89EA
Visitor Chair c/w Armrest
RM 518



ER5514F-92E
Visitor Chair w/o Armrest
RM 478

ER5510F-30A60
High Back Chair
RM 598

Moulded polypropylene fixed armrest in black finish.

Metal synchronized mechanism with 1 locking system.

Imported heavy duty pneumatic cylinder designed with safety & durability features.

Polypropylene base with 50mm nylon castors.



X-TREME Colour



CARA Colour



PETINA

The adjustable armrests of **PETINA** allow for precise positioning, providing optimal support for arms and shoulders. Combined with the adaptable seat, which offers height and depth adjustments, this series ensures a tailored seating experience that adapts effortlessly to your unique needs.



Type (Variations)



PG5111F-20D90
Medium Back Chair
RM 788



PG5112F-20D90
Low Back Chair
RM 778



PG5113F-89EA
Visitor Chair with Armrest
RM 568

X-TREME Colour



CARA Colour



PG5110F-20D90
High Back Chair
RM 798

Nylon adjustable armrest with nylon armpad to enhance support.

Self-weight adjustment synchronized mechanism with seat slide & multi-locking system.

Adjustable seat depth

Nylon high base comes with matching 60mm nylon dual-wheel castors.

ZANTE

Wrapped in full-fabric upholstery, it brings a touch of warmth and personality to any workspace. Available in variety of bold and refined fabric colours, **ZANTE** lets you express your style while staying productive.

Type (Variations)



OF-ZANTE-M
Medium Back Chair
RM 478



OF-ZANTE-L
Low Back Chair
RM 468



OF-ZANTE-V
Visitor Chair
RM 428

STAR40 Colour



OF-ZANTE-H
High Back Chair
RM 488

Combination "Chrome" and polypropylene armrest

Imported synchronized mechanism with "1" position locking system

Polypropylene PP base



KLAUS intuitively adapts to your movements, providing smooth and seamless transitions throughout the day. Embrace the power of personalized comfort and productivity with **KLAUS**, where every aspect is designed to enhance your work experience.

K L A U S

Type (Variations)



KR5411F-30A66
Medium Back Chair
RM 528



KR5412F-30A66
Low Back Chair
RM 518



KR5413F-89EA
Visitor Chair c/w Armrest
RM 508



KR5414F-92E
Visitor Chair w/o Armrest
RM 478

X-TREME Colour



CARA Colour



KR5410F-30A66
High Back Chair
RM 538

Moulded polypropylene fixed armrest in black finish.

Metalsynchronized mechanism with 1 locking system that comes with weight adjustable tension knob.

Strip capping with black finish located at the bottom of the chair backrest enhances upholstery.

Polypropylene base.



FABRIC CHAIR SERIES

Type (Variations)



Designed with a sleek, ergonomic profile, **KASTEL** provides excellent lumbar support, ensuring proper posture even during long hours of work. The moulded polypropylene armrests add a stylish contrast while offering gentle support for your arms.

K A S T E L



KL5611F-30A70
Medium Back Chair
RM 478



KL5613F-90EA70
Visitor Chair c/w Armrest
RM 458



KL5612F-30A70
Low Back Chair
RM 468



KL5610F-30A70
High Back Chair
RM 488

Moulded polypropylene L-armrest in black finish.

Metal spring mechanism with 1 locking system at the seat posture and tilt at 250 reclining position.

Imported heavy duty pneumatic cylinder designed with safety & durability features.

Polypropylene base.

X-TREME Colour



CARA Colour



MOTTO

The **MOTTO's** high-back design supports your posture, while the gracefully curved polypropylene armrests add a modern touch—proof that even essentials can be stylish. With **MOTTO**, you get more than just a chair—you get a reliable companion for your workspace.

Type (Variations)



OF-MOTTO-M
Medium Back Chair
RM 478



OF-MOTTO-L
Low Back Chair
RM 468



OF-MOTTO-V
Visitor Chair with Armrest
RM 428



OF-MOTTO-H
High Back Chair
RM 488

Fashionable Stylish
Polypropylene
PP armrest

Imported synchronized
mechanism with
"1" position locking
system

Polypropylene
PP base

STAR 40 FABRIC Colour



ORSIN

Say goodbye to backaches. **ORSIN** redefines comfort with its one-piece headrest and backrest, creating a sleek, uninterrupted form that provides full spinal support. Designed for professionals who demand both ergonomic functionality and refined aesthetics. **ORSIN** is the perfect addition to any workspace.

Type (Variations)



OF-ORSIN-M
Medium Back Chair
RM 588



OF-ORSIN-L
Low Back Chair
RM 578



OF-ORSIN-V
Visitor Chair
RM 558



OF-ORSIN-H
High Back Chair
RM 598

Adjustable Armrest with
PU armpad

Imported synchronized
mechanism with 3
position locking system

Polypropylene
PP base

STAR 40 FABRIC Colour



Crafted to endure, the **ERSA** Series boasts robust construction and durable materials. Every component, from the sturdy base to the fabric-clad backrest, reflects a commitment to both longevity and style.

ERSA

Type (Variations)



EXE70
Low Back Chair (EPOXY BLACK)
RM 385



EXE71-SE
Visitor Chair c/w Armrest (EPOXY BLACK)
RM 378

EXE69
High Back Chair (EPOXY BLACK)
RM 388



STAR 40 COLLECTION & TX FABRIC Colour



FABRIC CHAIR SERIES

Type (Variations)

For those who need a no-fuss, dependable office chair, **AFFINO** delivers just that. It provides essential comfort and support for everyday office tasks with no-frills.

AFFINO



OF-AFFINO-M
Medium Back Chair
RM 498



OF-AFFINO-V
Visitor Chair
RM 488



OF-AFFINO-L
Low Back Chair
RM 488



OF-AFFINO-H
High Back Chair
RM 508

STAR 40 & GALAXY FABRIC Colour



FIRENZE

At the heart of the **FIRENZE** Series lies its distinctive allure: the contoured headrest. This unique feature not only provides superior neck and head support but also adds a touch of sophistication to the overall aesthetic appeal of the chair.



Type (Variations)



FT5711F-32A76
Medium Back Chair
RM 458



FT5712F-32A76
Low Back Chair
RM 448



FT5713F-93EA76
Visitor Chair
RM 448

X-TREME Colour



CARA Colour



FT5710F-32A76
High Back Chair
RM 508

RASCAL

Uniquely crafted with horizontal seams adorning the backseat, **RASCAL** series exudes a distinctive charm while prioritizing comfort and support. This series exudes a distinctive charm that resonates with modern professionals seeking a blend of style and functionality.

Type (Variations)



OF-RAS-LB-A67-HLB1
Low Back Chair
RM 498



OF-RAS-V-A67-V4
Visitor Chair
RM 498

OF-RAS-HB-A67-HLB1
High Back Chair
RM 538

GALAXY FABRIC Colour

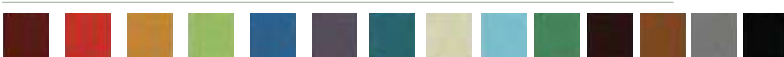

Crafted for those seeking a reliable seating solution without breaking the budget, **HUT 1** offers a comfortable seating experience at an affordable price point.

H U T 1

Type (Variations)



OF-H1F-LB-A62-M1-L1
Low Back Chair
RM 348



OF-H1F-V-A62-V1
Visitor Chair c/w Armrest
RM 328

OF-H1F-HB-A62-M1-L1
High Back Chair
RM 368

Durable polypropylene armrest.

Unibody Design

Adjustable height with lever.

Locking system

Polypropylene base



GALAXY FABRIC Colour



FABRIC CHAIR SERIES

Type (Variations)



OF-H2F-LB-A62-M1-L1
Low Back Chair
RM 348



OF-H2F-V-A62-V1
Visitor Chair c/w Armrest
RM 328

OF-H2F-HB-A62-M1-L1
High Back Chair
RM 368

Durable polypropylene armrest.

Unibody Design

Adjustable height with lever.

Locking system

Polypropylene base



H U T 2

Designed for those looking for a dependable seating option without exceeding their budget, **HUT 2** provides a comfortable seating experience at an accessible price point.

GALAXY FABRIC Colour



S A V O N A

The **SAVONA** high-back chair brings ergonomic excellence into your workspace. With a refined silhouette and a robust build, this chair delivers a premium seating experience, making it the ideal choice for those who value lasting comfort in their workspace.



Type (Variations)



SF8411F-24D91
Medium Back Chair
RM 1,008



SF8413F-89EA
Visitor Chair with Armrest
RM 828



SF8410F-24D91
High Back Chair
RM 1,088

Nylon backrest frame and adjustable lumbar support in transparent black finish

4D Adjustable Armrest with Polyurethane Armpad

Self-Weight Adjustment synchronized Mechanism (3 Lockings).

High density polyurethane moulded foam.

Nylon Base with 50 mm nylon castor

SOFTECH Colour



SOFTECH CHAIR SERIES

M A L F A

MALFA is upholstered with Softech fabric which delivers a plush yet breathable experience, complementing the chair's uninterrupted silhouette. The precision-engineered frame and synchronized reclining and mechanism ensure an effortless transition between tasks, promoting natural posture and adaptability.



Type (Variations)

MX8111F-20A68
Medium Back Chair
RM 1,438



MX8112F-20A69
Low Back Chair
RM 828



MX8113F-88EA69
Visitor Chair
RM 718



MX8110F-20A68
High Back Chair
RM 1,528

Moulded Nylon Fixed Armrest with PU Pad.

Adjustable lumbar support.

High density PU moulded foam.

Nylon Base with 60mm nylon castor.

Rotary Synchronized Mechanism (Multi-Locking).

SOFTECH Colour



FABRIC CHAIR SERIES



OF-HB-F10-A22H2B7-F
High Back Chair
RM 518



OF-MB-F10-A22H2B7-F
Medium Back Chair
RM 508



OF-LB-F10-A22H2B7-F
Low Back Chair
RM 498



OF-VB-F10-A22F35-F
Visitor Chair
RM 488



OF-HB-F11-A22H2B7-F
High Back Chair
RM 558



OF-MB-F11-A22H2B7-F
Medium Back Chair
RM 548



OF-LB-F11-A22H2B7-F
Low Back Chair
RM 538



OF-VB-F11-A22F35-F
Visitor Chair
RM 528



OF-HB-F13-A11H1B1-F
High Back Chair
RM 368



OF-MB-F13-A11H1B1-F
Medium Back Chair
RM 358



OF-LB-F13-A11H1B1-F
Low Back Chair
RM 348



OF-VB-F13-A11F3-F
Visitor Chair
RM 338



OF-HB-F14-A3H1B1-F
High Back Chair
RM 368



OF-MB-F14-A3H1B1-F
Medium Back Chair
RM 358



OF-LB-F14-A3H1B1-F
Low Back Chair
RM 348



OF-VB-F14-A3F3-F
Visitor Chair
RM 338



OF-HB-F15-A12H2B1-F
High Back Chair
RM 518



OF-MB-F15-A12H2B1-F
Medium Back Chair
RM 508



OF-LB-F15-A12H2B1-F
Low Back Chair
RM 498



OF-VB-F15-A12F35-F
Visitor Chair
RM 488



OF-HB-F16-A3H1B1-F
High Back Chair
RM 328



OF-MB-F16-A3H1B1-F
Medium Back Chair
RM 318



OF-LB-F16-A3H1B1-F
Low Back Chair
RM 308



OF-VB-F16-A3F3-F
Visitor Chair
RM 308



OF-HB-F17-A13H1B1-F
High Back Chair
RM 328



OF-MB-F17-A13H1B1-F
Medium Back Chair
RM 318



OF-LB-F17-A13H1B1-F
Low Back Chair
RM 308



OF-VB-F17-A13F3-F
Visitor Chair
RM 308



OF-HB-F18-A17H1B1-F
High Back Chair
RM 338



OF-MB-F18-A17H1B1-F
Medium Back Chair
RM 328



OF-LB-F18-A17H1B1-F
Low Back Chair
RM 318



OF-VB-F18-A17F3-F
Visitor Chair
RM 318



OF-HB-F19-A17H1B1-F
High Back Chair
RM 338



OF-MB-F19-A17H1B1-F
Medium Back Chair
RM 328



OF-LB-F19-A17H1B1-F
Low Back Chair
RM 318



OF-VB-F19-A17F3-F
Visitor Chair
RM 318



DA-HB-F20-A17H1B1-F
High Back Chair
RM 328



DA-MB-F20-A17H1B1-F
Medium Back Chair
RM 318



DA-LB-F20-A17H1B1-F
Low Back Chair
RM 318



DA-VB-F20-A17F3-F
Visitor Chair
RM 308



OF-HB-F21-A17H1B1-F
High Back Chair
RM 368



OF-MB-F21-A17H1B1-F
Medium Back Chair
RM 358



OF-LB-F21-A17H1B1-F
Low Back Chair
RM 348



OF-VB-F21-A17F3-F
Visitor Chair
RM 338



OF-HB-F22-A12H2B1-F
High Back Chair
RM 528



OF-MB-F22-A12H2B1-F
Medium Back Chair
RM 518



OF-LB-F22-A12H2B1-F
Low Back Chair
RM 508



OF-VB-F22-A12F35-F
Visitor Chair
RM 498

STAR40 COLLECTION Colour



FABRIC CHAIR SERIES

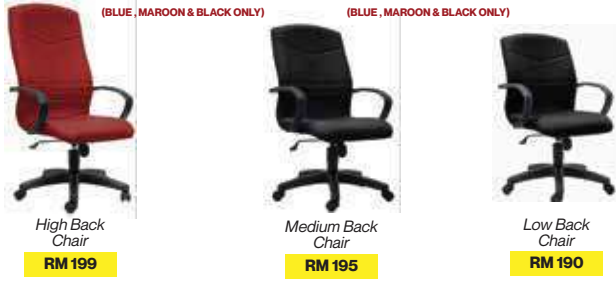

STAR40 COLLECTION Colour



PRODUCTION, DRAFTING & TYPIST CHAIR SERIES



HIGH BAR STOOL / DRAFTING CHAIR *Not Available for ZETA Colour



OF-491
RM 618



OF-492
RM 658



OF-496
RM 428



OF-500
RM 328



OF-520
RM 398



OF-TYP-A67-F1-L1
RM 508



OF-W1P-L1
RM 238



OF-W1P-F1-L1
RM 328



OF-W1P-F2-L3
RM 428



OF-700E
RM 220



OF-710E
RM 238



OF-730C
RM 268



OF-760C
RM 368

*Not Available for ZETA Colour

LOW BAR STOOL / MINI LOWBACK / TYPIST CHAIR *Not Available for ZETA Colour



OF-LO1-A67-HLB2
RM 348



OF-LO1-A0-HLB2
RM 318



OF-LO2-A67-HLB2
RM 338



OF-LO2-A0-HLB2
RM 308



OF-TYP-A67-L1
RM 448



OF-390HA
c/w amrest
RM 358

OF-391H
w/o amrest
RM 338



OF-392LA
RM 348



OF-393L
RM 318



OF-670E
RM 208



OF-600
RM 268



OF-680C
RM 248



OF-690C
RM 258



OF-482
RM 298

*Not Available for ZETA Colour



OF-484
RM 268



OF-590
RM 328



OF-540
RM 208



Southsea Blue



Garnet Burgundy

RM 138



OF-541
RM 228



Southsea Blue



Garnet Burgundy

RM 148



AR-CH-05A
c/w amrest
RM 185



Southsea Blue



Garnet Burgundy

Black



AR-CH-05
w/o amrest
RM 170



Southsea Blue



Garnet Burgundy

Black

TUSCANY PU Colour



ZETA Colour



STAR 40 COLLECTION Colour



*Images provided are for illustration purposes only. *Prices quoted are subject to change without prior notice & while stocks last.
*Terms & conditions apply. *While every care is taken in the preparation of this flyer any inaccuracy or omission is much regretted.

DYNAMIC Plus

Colour & Material Selection :



Daring. Distinctive. Dynamic. A heritage of perfection - blends classic luxury with superb comfort in a simple yet elegant design. A fully upholstered leather finished with classic boxed-like molded foam armrest which graces your presence at the higher echelons of power. Developed from complete concept of ergonomics and stability, this is the chair that tells most about who you are.

B20 : Aluminium Chair Base

F37 : Fixed Armrest

M11 : Dynamic Synchron Mechanism c/w Multilocking



B20

(-) RM 118

CHANGED TO



B15



L19-3-F37M11B20

Chair Height : 1000 - 1090
Chair Depth : 680
Chair Width : 660
Seat Height : 440 - 530
Seat Depth : 460
Seat Width : 520

PU : RM 2,198



L1-4

Chair Height : 940
Chair Depth : 660
Chair Width : 650
Seat Height : 440
Seat Depth : 460
Seat Width : 520

PU : RM 1,928



L19-1-F37M11B20

Chair Height : 1240 - 1330
Chair Depth : 680
Chair Width : 705
Seat Height : 440 - 530
Seat Depth : 470
Seat Width : 560

PU : RM 2,288



Contoured backrest of injection molded foam provides solid and durable backing.



Synchron multi locking mechanism makes it possible to achieve perfect balance in every seated position.



Sleek 5-pedestal chair base with 60mm castors in aluminium die-cast.

HUGO II

Colour & Material Selection :



A modern adaptation of a traditional chair, HUGO II impresses many its unique, sleek look combined with enhance ergonomics.

Devoted to the relentless pursuit of perfection, HUGO II is a luxury chair that complies with BIFMA and FIRA standards. An inspiration and a sight to behold, HUGO II delivers meticulous style and a promise of satisfaction.

A7 : Chrome Adjustable Armrest

M37 : Synchron Mechanism c/w Multi Locking

B20 : Aluminium Chair Base



B20

(-) RM 118

CHANGED TO



B15



L5-2-A7M37B20

Chair Height : 1025 - 1115
Chair Depth : 640
Chair Width : 690
Seat Height : 440 - 530
Seat Depth : 470
Seat Width : 530

PU : RM 1,898



L5-3-A7M37B20

Chair Height : 980
Chair Depth : 710
Chair Width : 640
Seat Height : 450
Seat Depth : 500
Seat Width : 530

PU : RM 1,858



Contoured backrest with side mounted tilt mechanism provides superior comfort, easy reclining and good back support in different positions.



Synchron multi locking mechanism makes it possible to achieve perfect balance in every seated position.



L5-1-A7M37B20

Chair Height : 1206 - 1295
Chair Depth : 640
Chair Width : 650
Seat Height : 440 - 530
Seat Depth : 470
Seat Width : 530

PU : RM 1,938

PALETTE II

MESH: TW-62 C



SEAT FABRIC: GALAXY II



The design for PALETTE strictly follows the shape and contours of the human body. Be it the mesh back version or the chillback chair, the idea and design behind the shape is the same, to meet the ergonomic needs while offering ease of use.

A29 : Nylon Adjustable Arm

M40 : 2 Locking with Auto Tension

B20 : Aluminium Chair Base

A29 : Nylon Adjustable Arm

B15 : Nylon Chair Base

F45 : Fix Armrest



M27-1-A29M40B15

Chair Height : 1175 - 1265
Chair Depth : 695
Chair Width : 640
Seat Height : 440 - 530
Seat Depth : 440
Seat Width : 510

RM 938



M27-2-A29M40B15

Chair Height : 985-1075
Chair Depth : 640
Chair Width : 640
Seat Height : 440 - 530
Seat Depth : 440
Seat Width : 510

RM 788



M27-4-CTL29F45

Chair Height : 970
Chair Depth : 600
Chair Width : 640
Seat Height : 450
Seat Depth : 440
Seat Width : 510

RM 638



A29

(-) RM 58
CHANGED TO



F45



B15

(+) RM 128
CHANGED TO



B20



B-XIMPLE ECO

A new generation of chairs. Meeting the highest aesthetic and ergonomic demands. Designed for spaces with a strong innovative technological presence.

MESH: TW-62 C



SEAT FABRIC: GALAXY II



B15 : Nylon Chair Base

A50 : Nylon Adjustable Arm with "PP" Armpad

M40 : 2 Locking

F40 : Fix Armrest

B20 : Aluminium Chair Base



A50

(-) RM 38
CHANGED TO



F40



B15

(+) RM 128
CHANGED TO



B20



M23N-ECO-1-A50M40B15

Chair Height : 1160 - 1250
Chair Depth : 700
Chair Width : 650
Seat Height : 430 - 520
Seat Depth : 470
Seat Width : 510

RM 708



M23N-ECO-2-A50M40B15

Chair Height : 970 - 1060
Chair Depth : 650
Chair Width : 630
Seat Height : 430 - 520
Seat Depth : 470
Seat Width : 510

RM 568



M23N-ECO-4-CTL29F40

Chair Height : 960
Chair Depth : 610
Chair Width : 630
Seat Height : 455
Seat Depth : 480
Seat Width : 510

RM 598





FLOW BASIC

MESH: AIA MESH



SEAT FABRIC: GALAXY II



M25-1-A39M39B15

Chair Height : 1190 - 1280
Chair Depth : 640
Chair Width : 630
Seat Height : 450 - 540
Seat Depth : 440
Seat Width : 510

FABRIC : RM 1,288



A39

(-) RM 58

CHANGED TO



F45

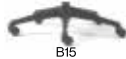

B15

(+) RM 128

CHANGED TO



B20

M39 : 1 Locking Mechanism

B15 : Nylon Chair Base

B20 : Aluminium Chair Base

F45 : Fixed Armrest

M25-2-A39M39B15

Chair Height : 1000 - 1090
Chair Depth : 640
Chair Width : 630
Seat Height : 430 - 520
Seat Depth : 440
Seat Width : 510

FABRIC : RM 1,158



Z365

MESH: ZOOM



SEAT FABRIC: GALAXY II



M34-1-A53M11B21

Chair Height : 1150 - 1240
Chair Depth : 695
Chair Width : 680-730
Seat Height : 430 - 520
Seat Depth : 450-520
Seat Width : 500

FABRIC : RM 2,508



A53 : Nylon Adjustable arm

M11 : Dynamic synchron mechanism

B21 : Dull Chrome

M34-2-A53M11B21

Chair Height : 960 - 1050
Chair Depth : 695
Chair Width : 680-730
Seat Height : 430 - 520
Seat Depth : 450-520
Seat Width : 500

FABRIC : RM 2,268



FEIN

MESH: FM



SEAT FABRIC: GALAXY II



M33-1-A53M47B20

Chair Height : 1170 - 1260
Chair Depth : 695
Chair Width : 680-730
Seat Height : 435 - 525
Seat Depth : 440-490
Seat Width : 505

FABRIC : RM 1,658



M33-2-A53M47B20

Chair Height : 995 - 1085
Chair Depth : 640
Chair Width : 680-730
Seat Height : 435 - 525
Seat Depth : 440-490
Seat Width : 505

FABRIC : RM 1,488

Sitting is how our time is mostly spent. It is important to sit right with the right posture and with the right office chair. FEIN, derived from the German word for "Fine & Slim", is intended for those who are looking for a delightful seating experience

A53 : Nylon Adjustable arm

M47 : 3 Locking Mechanism

B20 : Aluminium Leg

B15 : Nylon Chair Base



FEIN LITE

MESH: TW- 62 C



SEAT FABRIC: GALAXY II



Sitting is how our time is mostly spent. It is important to sit right with the right posture and with the right office chair. FEIN, derived from the German word for "Fine & Slim", is intended for those who are looking for a delightful seating experience.

A51 : Nylon Adjustable Arm

B20 : Aluminium Chair Base

M43 : 4 Locking with Auto Tension Sliding

B15 : Nylon Chair Base



M33L-1-A51M53B20

Chair Height : 1170 - 1260
Chair Depth : 690
Chair Width : 680-730
Seat Height : 445 - 535
Seat Depth : 450-500
Seat Width : 505

RM 1,428



B20

(-) RM 118

CHANGED TO



B15



M33L-2-A53M53B20

Chair Height : 1010 - 1100
Chair Depth : 640
Chair Width : 680-730
Seat Height : 440 - 530
Seat Depth : 450-500
Seat Width : 505

RM 1,248



BODY LITE



Freedom of movement and the user's posture are critical points of office health. A poorly designed chair will result in poor posture which causes musculoskeletal ailments which in turn increases absenteeism rates. That is why a well designed chair will not only ensure that the user maintains proper posture but also alleviate some of the pain for those who are already affected. With our latest seating solution, BODY LITE, we have your back.

Old expectations of a chair can finally be replaced by modern design and enhanced comfort. Instead of the traditional big, boxy and bulky designs from the past, Benithem has thrown away that norm and come up with a newer, sleeker and more comfortable design which is aesthetically pleasing as well.

With BODY LITE, freedom of the movement and proper posture are a given. You can rest assured that through our numerous research and development processes, we will only provide the best for you, BODY LITE.

BACK MESH COLOUR



SEAT FABRIC B



M22L-1-A51M48B15

Chair Height : 1200 - 1290
Chair Depth : 720
Chair Width : 660-720
Seat Height : 445 - 535
Seat Depth : 460-520
Seat Width : 510

RM 1,608



B15

(+) RM 128

CHANGED TO



B20

M48 : Multi Locking c/w Auto Tension Mechanism

B15 : Nylon Chair Base

A51 : Nylon Adjustable Arm



M22L-2-A51M48B15

Chair Height : 1000 - 1090
Chair Depth : 660
Chair Width : 660-720
Seat Height : 445-535
Seat Depth : 460-520
Seat Width : 510

RM 1,378



KNIGHT_{ECO}

MESH : TW-62 C



SEAT FABRIC : GALAXY II



A36 : Nylon Adjustable Arm

B20 : Aluminium Chair Base

M40 : 2 Locking with Auto Tension

B15 : Nylon Chair Base



B15

(+) RM 128

CHANGED TO



B20

M36ECO-1-A36M40B15

Chair Height : 1170 - 1260
 Chair Depth : 650
 Chair Width : 655-705
 Seat Height : 445 - 535
 Seat Depth : 420-475
 Seat Width : 500

RM 878



M36ECO-2-A36M40B15

Chair Height : 1020 - 1110
 Chair Depth : 640
 Chair Width : 655-705
 Seat Height : 445 - 535
 Seat Depth : 420-475
 Seat Width : 500

RM 798



BC3

MESH : TW-62 C



SEAT FABRIC : GALAXY II



It's bold, it's confident, it's three times the better - meet BC3, with an adaptable character, BC3 suits any kind of working environment, let it be the young and spirited office or the dignified firm, the design of BC3 suits them both by an effortless change of specifications of the chair. The dependable mechanism and it's many functions, including the active lumbar support are tenderly designed to ensure efficiency and safety in the working environment. Choices are provided with the colour of the seating and choices between headrest and non-headrest.

B15 : Nylon Chair Base

A26 : Nylon Adjustable Arm

M42 : Multi Locking



BC23-1-A26M55B15

Chair Height : 1170 - 1260
 Chair Depth : 640
 Chair Width : 630
 Seat Height : 430 - 520
 Seat Depth : 485
 Seat Width : 505

RM 1,228



A26

(-) RM 70

CHANGED TO



F45



BC23-2-A26M55B15

Chair Height : 1015 - 1105
 Chair Depth : 640
 Chair Width : 630
 Seat Height : 430 - 520
 Seat Depth : 485
 Seat Width : 505

RM 1,058



- F22** : Fixed Armrest
- M42** : 4 Locking Mechanism
- B20** : Aluminium Chair Base
- B15** : Nylon Chair Base

FLOW- Premium



M25P-1-A40M47B15 **RM 1,428** M25P-2-A40M47B15 **RM 1,288** M25P-1-A41M47B20 **RM 1,688** M25P-2-A41M47B20 **RM 1,548** B5-CTL-E **RM 848**

- A36** : Nylon Adjustable Arm
- M40** : Multi Locking Mechanism
- M43** : 4 Locking Mechanism
- B15** : Nylon Chair Base

B-XIMPLE



M23-1-A36M40B15 **RM 938** M23-2-A36M40B15 **RM 788** M23-1-F22M40B15 **RM 858** M23-2-F22M40B15 **RM 708** M23-4-CTL29F22 **RM 648**

- A40** : Nylon Adjustable Arm
- M47** : 3 Locking Mechanism
- B15** : Nylon Chair Base
- B20** : Aluminium Chair Base

FLOW- White



M25P-1-A40M47B20-W **RM 1,678** M25P-2-A40M47B20-W **RM 1,508** M25P-1-A40M47B15-W **RM 1,558** B25P-2-A40M47B15-W **RM 1,388**

B23

B18



B-23-HB-AJ9M14CB6 **RM 858** B-23-MB-AJ9M14CB6 **RM 798** B-23-CTL6FA11 **RM 578** B-23-HB-FA16M14CB1 **RM 698** B-23-MB-FA16M14CB1 **RM 628** B-18-HB-A9M3CB1 **RM 688** B-18-MB-AJ9M3CB1 **RM 618** B-18-HB-FA16M3CB1 **RM 638** B-18-MB-FA16M3CB1 **RM 568**

- FA16** : Fixed Armrest
- AJ9** : Nylon Adjustable Armrest
- M14** : 1 Locking Mechanism

B15 Plus



B-15P-HB-AJ9M14CB1 **RM 678** B-15P-MB-AJ9M14CB1 **RM 658** B-15P-LB-AJ9M14CB1 **RM 648** B-15P-HB-FA16M14CB1 **RM 628** B-15P-MB-FA16M14CB1 **RM 608** B-15P-LB-FA16M14CB1 **RM 598** B-15P-CTL6FA5 **RM 518**

- A15** : Adjustable Armrest
- M43** : 4 Locking System
- B20** : Aluminium Leg
- B15** : Nylon Chair Base

PALETTE II White



M27-1-A15M43B20-W **RM 1,308** M27-2-A15M43B20-W **RM 1,128** M27-1-A15M43B15-W **RM 1,438** M27-2-A15M43B15-W **RM 1,258**

- AJ10** : Chrome Adjustable Armrest
- M15** : 3 Locking Mechanism
- CB6** : Aluminium Chair Base
- CB1** : Nylon Chair Base

B11 Plus



B-11P-HB-AJ10M15CB6 **RM 888** B-11P-MB-AJ10M15CB6 **RM 798** B-11P-LB-AJ10M15CB6 **RM 798** B-11P-HB-AJ10M2CB1 **RM 778** B-11P-MB-AJ10M2CB1 **RM 698** B-11P-LB-AJ10M2CB1 **RM 698**

PRESTIGE



DX-PRT-01 SS
L1010*W900*H870 mm
RM 3,148



DX-PRT-02 DS
L1750*W900*H870 mm
RM 4,718



DX-PRT-100 CT
L1000*W1000*H420 mm
RM 2,298



SPECIFICATION:

- SOFA LEGS – Varnished wood.
- FINE STITCHES – Enhanced upholstery & fine stitching.
- FRAME – Solid wooden frame come with zigzag spring.
- SPONGE – Memory PU moulded foam with high density polyurethane sponge.
- MATERIALS : Leather / Fabrics / Synthetic Leather.

SYNTHETIC Leather / XTREME Fabric

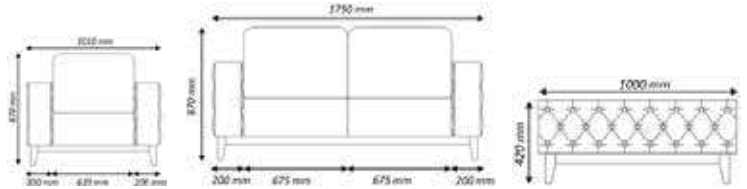

SETTEE SERIES

TOMATO



DX-TOM-01 SS
W960*D800*H735 mm
RM 2,138



DX-TOM-02 DS
W1570*D800*H735 mm
RM 2,948



DX-TOM-03 TS
W2070*D800*H735 mm
RM 3,838



SPECIFICATION:

- SOFA LEGS – Fully fabric wrap / Laminated wooden base / Stainless steel in hairline finish.
- FINE STITCHES – Enhanced upholstery & fine stitching.
- FRAME – Solid wooden frame come with zigzag spring.
- SPONGE – Memory PU moulded foam with high density polyurethane sponge.
- MATERIALS : Leather / Fabrics / Synthetic Leather.

SYNTHETIC Leather / XTREME Fabric

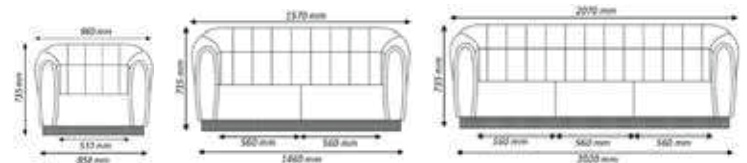

HECTOR



DX-HCT-01 SS
W980*D750*H690 mm
RM 1,838



DX-HCT-02 DS
W1540*D750*H690 mm
RM 2,588



DX-HCT-03 TS
W2100*D750*H690 mm
RM 3,548



SPECIFICATION:

- SOFA LEGS – Fixed stainless steel frame legs in polished finish come with adjustable stud in black colour.
- FINE STITCHES – Enhanced upholstery & fine stitching.
- SPONGE : Memory PU moulded foam with high density polyurethane sponge.
- MATERIALS : Leather / Fabrics / Synthetic Leather.

SYNTHETIC Leather / XTREME Fabric

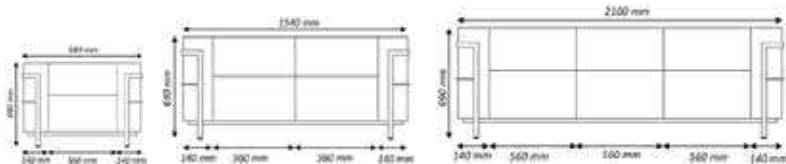

MILLER



OF-MLR-01 SS
L950*W760*H720 mm
RM 2,238



OF-MLR-02 DS
L1520*W760*H720 mm
RM 3,088



OF-MLR-03 TS
L2090*W760*H720 mm
RM 4,028



OF-MLR-CT01-PT
L1000*W1000*H420 mm
RM 2,688

SPECIFICATION:

- SOFA LEGS – Fully fabric wrap / Laminated wooden base / Stainless steel in hairline finish.
- FINE STITCHES – Enhanced upholstery & fine stitching
- FRAME – Solid wooden frame come with zigzag spring.
- SPONGE – Memory PU moulded foam with high density polyurethane sponge.
- MATERIALS: Leather / Fabrics / Synthetic Leather.

SYNTHETIC Leather / XTREME Fabric

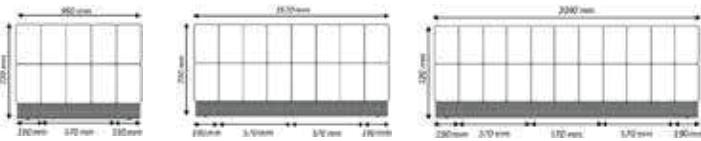

SETTEE SERIES



DX-CM-01 SS
W1000*D750*H690 mm
RM 1,928



DX-CM-02 DS
W1600*D750*H690 mm
RM 2,668



DX-CM-03 TS
W2200*D750*H690 mm
RM 3,488

SPECIFICATION:

- SOFA LEGS –Stainless steel in hairline finish.
- FINE STITCHES – Enhanced upholstery & fine stitching.
- FRAME – Solid wooden frame come with zigzag spring.
- SPONGE – Memory PU moulded foam with high density polyurethane sponge.
- MATERIALS: Leather / Fabrics / Synthetic Leather.

SYNTHETIC Leather / XTREME Fabric

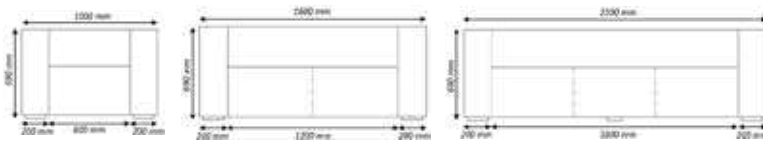

CHIME



OF-MXM-01 SS
L1000*W750*H690 mm
RM 1,928



OF-MXM-02 DS
L1600*W750*H690 mm
RM 2,668



OF-MXM-03 TS
L2200*W750*H690 mm
RM 3,488



OF-MXM-CT-GT
L1000*W1000*H420 mm
RM 1,968

SPECIFICATION:

- SOFA LEGS –Stainless steel in hairline finish.
- FINE STITCHES – Enhanced upholstery & fine stitching.
- FRAME – Solid wooden frame come with zigzag spring.
- SPONGE – Memory PU moulded foam with high density polyurethane sponge.
- MATERIALS: Leather / Fabrics / Synthetic Leather.

SYNTHETIC Leather / XTREME Fabric

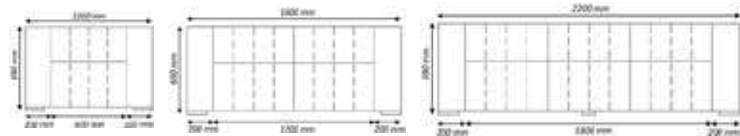

KAHIKI



DX-KHK-01 SS
W970*D790*H770
RM 1,328



DX-KHK-02 DS
W1580*D790*H770
RM 1,828



DX-KHK-03 TS
W2140*D790*H770
RM 2,388



SPECIFICATION :

- SOFA LEGS – Varnished wooden base & fixed stainless steel leg come with 10 mm adjustable rubber stud.
- FINE STITCHES – Enhanced upholstery & fine stitching.
- FRAME – Solid wooden frame come with zigzag spring.
- SPONGE – Memory PU moulded foam with high density polyurethane sponge.
- MATERIALS : Leather / Fabrics / Synthetic Leather.

SYNTHETIC Leather / X TREME Fabric

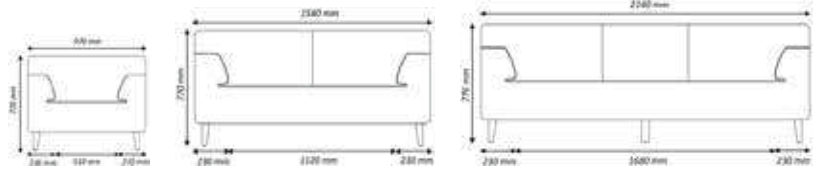

SETTEE SERIES

ZITA



ZT023-1A
W800*D700*H810
RM 1,238



ZT023-2A
W1360*D700*H810
RM 1,728



ZT023-3A
W1920*D700*H810
RM 2,438



SPECIFICATION :

- SOFA LEGS – Stainless steel in hairline finish.
- FINE STITCHES – Enhanced upholstery & fine stitching
- POCKET SPRING – High density polyurethane foam come with pocket spring.
- SPONGE – High density polyurethane sponge.
- MATERIALS : Leather / Fabrics / Synthetic Leather.

SYNTHETIC Leather / X TREME Fabric

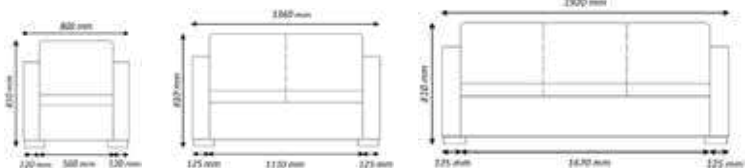

KIMBERLY



KB015-1
W870*D740*H720
RM 1,688



KB015-2
W1380*D740*H720
RM 2,368



KB015-3
W1930*D740*H720
RM 3,058



SPECIFICATION :

- SOFA LEGS – Fixed metal chrome base come with adjustable stud.
- FINE STITCHES – Enhanced upholstery & fine stitching.
- POCKET SPRING – High density polyurethane foam come with pocket spring.
- SPONGE – High density polyurethane sponge.
- MATERIALS : Leather / Fabrics / Synthetic Leather.

SYNTHETIC Leather / X TREME Fabric

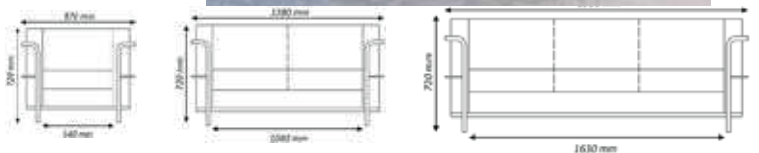

URBAN



DX-URB-01 SS
W820*D760*H820 mm
RM 1,528



DX-URB-02 DS
W1380*D760*H820 mm
RM 2,108



DX-URB-03 TS
W1940*D760*H820 mm
RM 2,748

SPECIFICATION:

- SOFA LEGS – Varnished wooden base / Stainless steel in polished finish.
- FINE STITCHES – Enhanced upholstery & fine stitching
- FRAME – Solid wooden frame come with zigzag spring.
- SPONGE – Memory PU moulded foam with high density polyurethane sponge.
- MATERIALS : Leather / Fabrics / Synthetic Leather.

SYNTHETIC Leather / XTREME Fabric

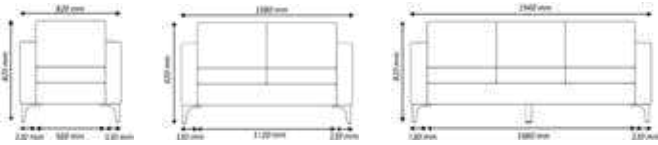

SETTEE SERIES

LOUFT



DX-LOU-01 SS
W820*D720*H700 mm
RM 1,528



DX-LOU-02 DS
W1380*D720*H700 mm
RM 2,108



DX-LOU-03 TS
W1940*D720*H700 mm
RM 2,748

SPECIFICATION:

- SOFA LEGS – Varnished wooden base.
- FINE STITCHES – Enhanced upholstery & fine stitching.
- FRAME – Solid wooden frame come with zigzag spring.
- SPONGE – Memory PU moulded foam with high density polyurethane sponge.
- MATERIALS : Leather / Fabrics / Synthetic Leather.

SYNTHETIC Leather / XTREME Fabric

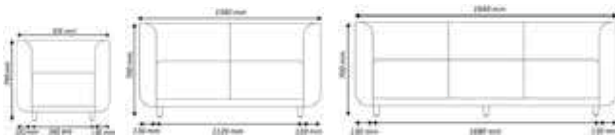

SHADE



DX-SHD-01 SS
W850*W690*H680 mm
RM 1,038



DX-SHD-02 DS
W1460*W690*H680 mm
RM 1,438



DX-SHD-03 DS
W2020*W690*H680 mm
RM 1,878

SPECIFICATION:

- SOFA LEGS – Varnished wooden base / Stainless steel finish.
- FINE STITCHES – Enhanced upholstery & fine stitching.
- FRAME – Solid wooden frame come with zigzag spring.
- SPONGE – Memory PU moulded foam with high density polyurethane sponge.
- MATERIALS : Leather / Fabrics / Synthetic Leather.

SYNTHETIC Leather / XTREME Fabric



ROWENA



OF-ROW-01 SS
W910*D795*H780 mm
RM 1,528

OF-ROW-02 DS
W1520*D795*H780 mm
RM 2,108

OF-ROW-03 TS
W2080*D795*H780 mm
RM 2,748

OF-ROW-120 CT
W1200*D750*H430 mm
RM 1,788



SPECIFICATION:

- SOFA LEGS – Varnished wooden base / Stainless steel in polished finish.
- FINE STITCHES – Enhanced upholstery & fine stitching
- FRAME – Solid wooden frame come with zigzag spring.
- SPONGE – Memory PU moulded foam with high density polyurethane sponge.
- MATERIALS : Leather / Fabrics / Synthetic Leather.

SYNTHETIC Leather / X TREME Fabric

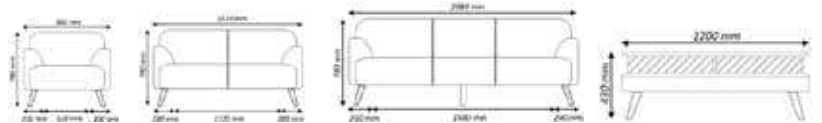

SETTEE SERIES

KRIS



DX-KRS-01 SS
W910*D735*H685 mm
RM 1,328

DX-KRS-02 DS
W1420*D735*H685 mm
RM 1,828

DX-KRS-03 TS
W1930*D735*H685 mm
RM 2,388



SPECIFICATION:

- SOFA LEGS – Varnished wooden base / Stainless steel in polished finish.
- FINE STITCHES – Enhanced upholstery & fine stitching
- FRAME – Solid wooden frame come with zigzag spring.
- SPONGE – Memory PU moulded foam with high density polyurethane sponge.
- MATERIALS : Leather / Fabrics / Synthetic Leather.

SYNTHETIC Leather / X TREME Fabric

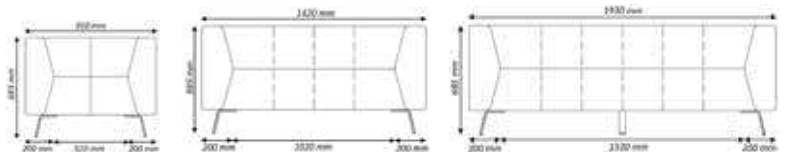

TIMELESS



DX-TIM-01 SS
W850*D690*H680
RM 1,528

DX-TIM-02 DS
W1460*D690*H680
RM 2,108

DX-TIM-03 TS
W2020*D690*H680
RM 2,748



SPECIFICATION:

- SOFA LEGS – 25mm (ht) black round stud.
- FINE STITCHES – Enhanced upholstery & fine stitching.
- FRAME – Solid wooden frame come with zigzag spring.
- SPONGE – Memory PU moulded foam with high density polyurethane sponge.
- MATERIALS : Leather / Fabrics / Synthetic Leather.

SYNTHETIC Leather / X TREME Fabric

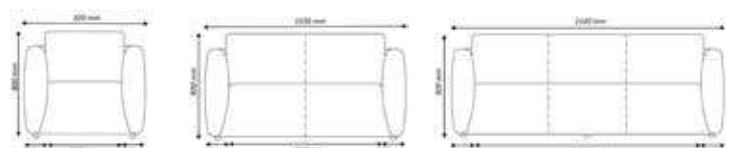

FOCAL



DX-FOC-01 SS
W850*D690*H680 mm
RM 998



DX-FOC-02 DS
W1460*D690*H680 mm
RM 1,388



DX-FOC-03 TS
W2020* 690*H680 mm
RM 2,388

SPECIFICATION:

- SOFA LEGS – Metal leg in black epoxy finish.
- FINE STITCHES – Enhanced upholstery & fine stitching
- FRAME – Solid wooden frame come with zigzag spring.
- SPONGE – Memory PU moulded foam with high density polyurethane sponge.
- MATERIALS : Leather / Fabrics / Synthetic Leather.

SYNTHETIC Leather / XTREME Fabric

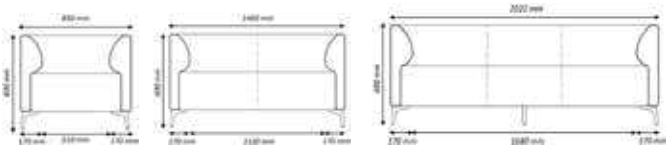

SETTEE SERIES



BS-3217-1S
W825*D775*H775 mm
RM 768



BS-3217-2S
W1335*D775*H775 mm
RM 998



BS-3217-3S
W1840*D775*H775 mm
RM 1,348

ZETA Pu Colour



GELSO



GS-3218-1S
W1065*D965*H965 mm
RM 1,358



GS-3218-2S
W1600*D965*H965 mm
RM 1,518



GS-3218-3S
W2135*D965*H965 mm
RM 2,388

ZETA Pu Colour



MAKO

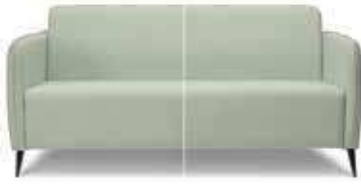

OF-MAK-03 TS
W1800*W750*H880 mm
RM 2,098



OF-MAK-01 SS
W720*W750*H880 mm
RM 1,288



OF-MAK-02 DS
W1260*W750*H880 mm
RM 1,688

MORIPU Colour



SETTEE SERIES

YOYO



OF-YOY-03 TS
W1850*W730*H800 mm
RM 1,838



OF-YOY-01 SS
W800*W730*H800 mm
RM 1,028



OF-YOY-02 DS
W1300*W730*H800 mm
RM 1,428

MORIPU Colour



NIKOLA



OF-NIK-03 TS
W2200*W780*H700 mm
RM 1,888



OF-NIK-01 SS
W970*W780*H700 mm
RM 1,048



OF-NIK-02 DS
W1500*W780*H700 mm
RM 1,488

MORIPU Colour





U NION



UNLS 905
Clover Low Stool
W1578*H420 mm
RM 1,508



UNLS 901
Round Low Stool
W380*H420 mm
RM 378



UNLS 902
Triangle Low Stool
W410*H420 mm
RM 388



UNLS 903
Square Low Stool
W400*H420*D400 mm
RM 428



UNLS 904
Bench
W900*H380*D600 mm
RM 648



UNLS 906
Round Low Stool
W600*H380 mm
RM 558



UNLS 907
Round Low Stool Table
W600*H396 mm
RM 658



UNLS 908
Partial Low Stool
W600*H380 mm
RM 608



UNLS 910-C
Chair with Castor
W600*H630 mm
RM 868

The Next Level Xtreme



SETTEE SERIES



K EY FACTOR



DM-KFT-02D-RS
Double Seater with Right Arm
W600*D1190*D735 mm
RM 1,188



DM-KFT-02D-BOT
Bench with Open Shelf Table
W600*D1120*H510 mm
RM 1,058



DM-KFT-01S-CS
Single Seater without Arm
W600*D560*H735 mm
RM 718



**DM-KFT-01S-CS/
DM-KFT-01S-ST**
Single Seater without Arm
with Side Table
W600*D560*H735 mm/
W600*D560*H375 mm
RM 1,368



DM-KFT-01S-ARB
Single Seater Auto Rotating Base
W600*D700*H735 mm
RM 1,228

The Next Level Xtreme



S ADDLE



OF-SAD-02SS
Double Seater
W1070*H800*D840 mm
RM 1,088



OF-SAD-03QTS
Triangle Seater
W1270*H830*D450 mm
RM 758



OF-SAD-03TS
Triple Seater
W1620*H800*D840 mm
RM 1,338

MORIPU Colour



SETTEE SERIES



KONNECT SERIES



OF-KON-01 SS
W770*D830*H730 mm
RM 1,128



OF-KON-02 DS
W1300*D830*H730 mm
RM 1,558



OF-KON-03 TS
W1820*D830*H730 mm
RM 1,958

MILANO SERIES



OF-MIL-01 SS
W840*D830*H870 mm
RM 1,128



OF-MIL-02 DS
W1370*D830*H870 mm
RM 1,558



OF-MIL-03 TS
W1900*D830*H870 mm
RM 1,958

LOLA SERIES



OF-LOL-01 SS
W820*D780*H770 mm
RM 1,028



OF-LOL-02 DS
W1350*D780*H770 mm
RM 1,428



OF-LOL-03 TS
W1870*D780*H770 mm
RM 1,838

RYDER SERIES



OF-RYD-01 SS
W760*D710*H880 mm
RM 1,128



OF-RYD-02 DS
W1290*D710*H880 mm
RM 1,558



OF-RYD-03 TS
W1830*D710*H880 mm
RM 1,958

NOOR SERIES



OF-NOO-01 SS
W770*D850*H780 mm
RM 1,028



OF-NOO-02 DS
W1350*D850*H780 mm
RM 1,428



OF-NOO-03 TS
W1830*D850*H780 mm
RM 1,838

RAZAR SERIES



OF-RAZ-01 SS
W770*D780*H760 mm
RM 1,028



OF-RAZ-02 DS
W1330*D780*H760 mm
RM 1,428



OF-RAZ-03 TS
W1850*D780*H760 mm
RM 1,838

KAMIIVO SERIES



OF-KAM-01 SS
W820*D750*H760 mm
RM 1,188



OF-KAM-02 DS
W1350*D750*H760 mm
RM 1,588



OF-KAM-03 TS
W1880*D750*H760 mm
RM 2,008

MYNA SERIES



OF-MYN-01 SS
W820*D750*H760 mm
RM 1,028



OF-MYN-02 DS
W1330*D750*H760 mm
RM 1,428



OF-MYN-03 TS
W1880*D750*H760 mm
RM 1,838

KEY SERIES



OF-KEY-01 SS
W820*D770*H760 mm
RM 1,028



OF-KEY-02 DS
W1350*D770*H760 mm
RM 1,428



OF-KEY-03 TS
W1890*D770*H760 mm
RM 1,838

EMBOSS SERIES



OF-EMB-01 SS
W800*D730*H770 mm
RM 1,038



OF-EMB-02 DS
W1330*D730*H770 mm
RM 1,458



OF-EMB-03 TS
W1850*D730*H770 mm
RM 1,868

LENNOX SERIES



OF-LEN-01 SS
W850*D850*H830 mm
RM 1,128



OF-LEN-02 DS
W1360*D850*H830 mm
RM 1,558



OF-LEN-03 TS
W1900*D850*H830 mm
RM 1,958

MUZZIE SERIES



OF-MUZ-01 SS
W810*D780*H700 mm
RM 1,258



OF-MUZ-02 DS
W1330*D780*H700 mm
RM 1,678



OF-MUZ-03 TS
W1860*D780*H700 mm
RM 2,088

PU COLOUR OPTION :



SETTEE SERIES



AGLIO SERIES



AG-1131-1S
W1710*D735*H840 mm
RM 1,128



AG-1131-2S
W1245*D735*H840 mm
RM 1,488



AG-1131-3S
W1750*D735*H840 mm
RM 1,978

BORLOTTI SERIES



BR-1103-1S
W785*D890*H875 mm
RM 1,168



BR-1103-2S
W1295*D890*H875 mm
RM 1,538



BR-1103-3S
W1805*D890*H875 mm
RM 2,048

CAROTA SERIES



RT-3219-1S
W1168*D915*H978 mm
RM 1,238



RT-3219-2S
W1675*D915*H978 mm
RM 1,628



RT-3219-3S
W2235*D915*H978 mm
RM 2,168

MANDORLA SERIES



MD-1107-1S
W785*D915*H952 mm
RM 1,538



MD-1107-2S
W1295*D915*H952 mm
RM 2,038



MD-1107-3S
W1805*D915*H952 mm
RM 2,718

MORA SERIES



MR-1132-1S
W760*D735*H840 mm
RM 818



MR-1132-2S
W1280*D735*H840 mm
RM 1,148



MR-1132-3S
W1815*D735*H840 mm
RM 1,428

SUSINA SERIES



SN-1105-1S
W785*D915*H952 mm
RM 1,468



SN-1105-2S
W1295*D915*H952 mm
RM 1,958



SN-1105-3S
W1805*D915*H952 mm
RM 2,448

ARANCIA SERIES



RN-1118-1S
W760*D735*H750 mm
RM 978



RN-1118-2S
W1270*D735*H750 mm
RM 1,278



RN-1118-3S
W1780*D735*H750 mm
RM 1,708

FRAGOLA SERIES



FR-1119-1S
W965*D825*H762 mm
RM 1,428



FR-1119-2S
W1420*D825*H762 mm
RM 1,878



FR-1119-3S
W1930*D825*H762 mm
RM 2,508

LIMONE SERIES



LM-1129-1S
W710*D765*H760 mm
RM 1,128



LM-1129-2S
W1245*D765*H760 mm
RM 1,488



LM-1129-ST
W1745*D765*H760 mm
RM 2,178



LM-1129-3S
W1740*D765*H760 mm
RM 1,978

ZUCCA SERIES



ZC-1121-1S
W890*D925*H890 mm
RM 998



ZC-1121-2S
W1500*D925*H890 mm
RM 1,318



ZC-1121-3S
W2105*D925*H890 mm
RM 1,758

MENTA SERIES



MN-3132-1S
W1015*D890*H915 mm
RM 948



MN-3132-2S
W1575*D890*H915 mm
RM 1,248



MN-3132-3S
W2080*D890*H915 mm
RM 1,668

CIPOLLA SERIES



CP-1120-1S
W940*D635*H750 mm
RM 948



CP-1120-2S
W1675*D635*H750 mm
RM 1,248



CP-1120-3S
W2415*D635*H750 mm
RM 1,668

ZETAPU
COLOUR OPTION :



TOMOFABRIC
COLOUR OPTION :



SETTEE SERIES



FLUIDO SERIES



OF-FLU-01SS
W965*D927*H940 mm
RM 868



OF-FLU-02DS
W1473*D927*H940 mm
RM 1,188



OF-FLU-03TS
W2032*D927*H940 mm
RM 1,548

SOVO SERIES



OF-SOV-01SS
W1220*D930*H995 mm
RM 1,078



OF-SOV-02DS
W1760*D930*H995 mm
RM 1,478



OF-SOV-03TS
W2300*D930*H995 mm
RM 1,928

NAPA SERIES



OF-NAP-01SS
W1041*D864*H876 mm
RM 758



OF-NAP-02DS
W1575*D864*H876 mm
RM 1,048



OF-NAP-03TS
W2108*D864*H876 mm
RM 1,358

NISMO SERIES



OF-NIS-01SS
W940*D1045*H965 mm
RM 1,078



OF-NIS-02DS
W1465*D1045*H965 mm
RM 1,488



OF-NIS-03TS
W2030*D1045*H965 mm
RM 1,938

YARRA SERIES



OF-YAR-01SS
W1080*D838*H813 mm
RM 1,058



OF-YAR-02DS
W1664*D838*H813 mm
RM 1,438



OF-YAR-03TS
W2172*D838*H813 mm
RM 1,898

KOMO SERIES



OF-KOM-01SS
W1067*D914*H965 mm
RM 908



OF-KOM-02DS
W1575*D914*H965 mm
RM 1,248



OF-KOM-03TS
W2083*D914*H965 mm
RM 1,628

JAYNA SERIES



OF-JAY-01SS
W950*D760*H830 mm
RM 1,098



OF-JAY-02DS
W1490*D760*H830 mm
RM 1,518



OF-JAY-03TS
W2030*D760*H830 mm
RM 1,968

KASUMI SERIES



OF-KAS-01SS
W1070*D940*H860 mm
RM 918



OF-KAS-02DS
W1600*D940*H860 mm
RM 1,258



OF-KAS-03TS
W2050*D940*H860 mm
RM 1,628

VESPER SERIES



OF-VES-01SS
W950*D760*H655 mm
RM 1,098



OF-VES-02DS
W1490*D760*H655 mm
RM 1,518



OF-VES-03TS
W2030*D760*H655 mm
RM 1,968

AKIRA SERIES



OF-AKI-01SS
W1070*D940*H860 mm
RM 998



OF-AKI-02DS
W1600*D940*H860 mm
RM 1,368



OF-AKI-03TS
W2050*D940*H860 mm
RM 1,778

PEDRO SERIES



OF-PED-01SS
W910*D795*H850 mm
RM 798



OF-PED-02DS
W1460*D795*H850 mm
RM 1,098



OF-PED-03TS
W2010*D795*H850 mm
RM 1,428

ALITA SERIES



OF-ALI-01SS
W978*D851*H978 mm
RM 838



OF-ALI-02DS
W1486*D851*H978 mm
RM 1,148





























OF-ALI-03TS
W1994*D851*H978 mm
RM 1,498

ELITE PU
COLOUR OPTION :



COFFEE TABLE SERIES

 <p>OFIS CT2440 L1000*W600*H460 mm</p> <p>RM 628</p>	 <p>OFIS CT132-SET L1200*W600 mm L500*W500 mm</p> <p>RM818</p>	 <p>OFIS S146 C/TBL L1200*D600*H440 mm</p> <p>RM 500</p>	 <p>OFIS S146 S/TBL W600*D600*H500 mm</p> <p>RM 400</p>
 <p>OFIS CT311-SET Ø700*H430 mm Ø500*H380 mm</p> <p>RM 308</p>	 <p>OFIS CT38-SET W800*D550*H380 mm</p> <p>RM 388</p>	 <p>OFIS RST601 Ø500*H560 mm</p> <p>RM 378</p>	 <p>OFIS M611-SET Ø700*H460 mm Ø500*H390 mm</p> <p>RM 418</p>
 <p>OFIS CT5001 L1000*W500*H450 mm</p> <p>DIRTY OAK CAPPUCCINO WALNUT</p> <p>RM 288</p>	 <p>OFIS M551-SET Ø700*H460 mm Ø500*H380 mm</p> <p>RM 588</p>	 <p>OFIS CT862-SET Ø700*H420 mm Ø500*H500 mm</p> <p>RM 498</p>	 <p>OFIS CT1882 W1200*D600*H470 mm</p> <p>RM 458</p>
 <p>OFIS CT531 W1200*D600*H440 mm</p> <p>RM 600</p>	 <p>OFIS CT114 W1100*D550*H440 mm</p> <p>RM 408</p>	 <p>OFIS CT-36 W1200*D600*H480 mm</p> <p>RM 308</p>	 <p>OFIS CT 3W W1000*D500*H450 mm</p> <p>RM 388</p>
 <p>OFIS CT 4W W1000*D500*H450 mm</p> <p>RM 388</p>	 <p>Colour Options:</p> <p>OFIS CT8570 L1000*W600*H455 mm</p> <p>RM 518</p>	 <p>Colour Options:</p> <p>OFIS CT MAYA Ø550*H500 mm</p> <p>RM 228</p>	 <p>OFIS H2-CTI050 L1000*W500*H460 mm</p> <p>RM 228</p>
 <p>OFIS H2-CT8080 L800*W800*G435 mm</p> <p>RM 268</p>	 <p>Colour Options:</p> <p>OFIS DT60R MLV Ø600*H450 mm</p> <p>RM 358</p> <p>OFIS DT75R MLV Ø750*H450 mm</p> <p>RM 418</p>	 <p>Colour Options:</p> <p>OFIS DT6060 MLV Ø600*H450 mm</p> <p>RM 358</p> <p>OFIS DT7575 MLV 750*750*H450 mm</p> <p>RM 418</p>	 <p>Colour Options:</p> <p>OFIS HPL R800 MLT Ø800*H435 mm</p> <p>RM 318</p>
 <p>Colour Options:</p> <p>OFIS HPL8080 MLT L800*W800*H435 mm</p> <p>RM 298</p>	 <p>Colour Options:</p> <p>OFIS HPL70120 MLT2 L1200*W700*H435 mm</p> <p>RM 498</p>	 <p>OFIS CT2439 L1000*W600*H460 mm</p> <p>RM 418</p>	

LUX Series



COLOUR



MAHOGANY 2.0
&
BLACK



PRODUCT SPECIFICATION

MAIN TABLE

OF-LUX-01

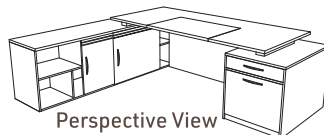

Perspective View

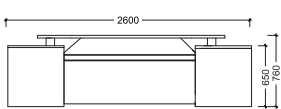

Front View
(Visitor Side)

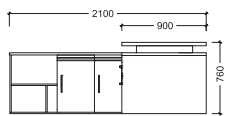

Side View

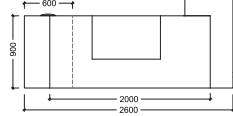

Top View

CABINET

OF-LUX-02

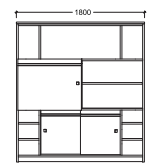

Front View



Side View



Perspective View

TECHNICAL SPECIFICATION

Executive Desk & Integral Storage Unit

L-Configuration (available in left and right models)

Width	Depth	Height (mm)
<i>Left / Right hand</i>		
2600	2100	750
<i>Left / Right hand</i>		
2600	2100	750

Table top thickness = 41 mm

Material

Melamine Faced Chipboard

Description

Attached side storage consists of -
a. one full-size big drawers
b. two sliding doors cabinet
c. open shelf
*premium profile handle and soft-close feature

Model

OF-LUX-L-01

OF-LUX-R-01

RM 3,488

Medium Storage

Freestanding storage cabinet with Premium profile handle

Width	Depth	Height (mm)
1800	450	2000

Material

Melamine Faced
Chipboard

Description

Three-tier open bookcase with
3 sliding doors

Model

OF-LUX-02

RM3,688

Model

WRITING PAD *(INCLUDED)

W700 * D500 * 1.2 THK (MM)

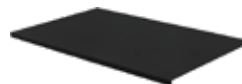

GRANDE Series



COLOUR

SCHATTEN
&
BLACK



PRODUCT SPECIFICATION

MAIN TABLE

OF-GRANDE-01

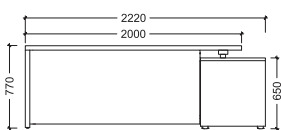

Front View
(Visitor Side)

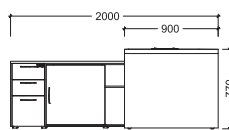

Side View

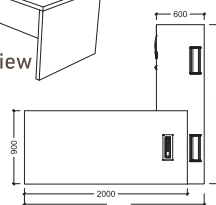

Top View

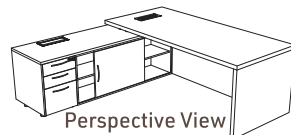

Perspective View

CABINET

OF-GRANDE-02

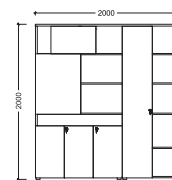

Front View



Side View



Perspective View

TECHNICAL SPECIFICATION

Executive Desk & Integral Storage Unit

L-Configuration (available in left and right models)

Width	Depth	Height (mm)
Left hand		
2200	2000	770
Right hand		
2200	2000	770

Table top thickness = 41 mm

Material

Melamine Faced
Chipboard

Description

Attached side storage consists of -
a. three drawers with combination lock
b. one sliding door cabinet
c. open shelf

* Netbox turn (2 power socket boxes, 2 USB ports, telephone, Lan ports.)



Model

OF-GRANDE-L-01

RM 3,288

OF-GRANDE-R-01

High Storage

Freestanding storage cabinet, finger pull doors

Width	Depth	Height (mm)
2000	500	2000

Material

Melamine Faced
Chipboard

Optional



Description

- two sliding door cabinet
- one full swing door wardrobe with adjustable shelf and a suspended clothes bar
- three swing doors cabinet
- open shelf

Model

OF-GRANDE-02

RM 4,828

Model

1. WRITING PAD

W700 * D500 * 1.2 THK (MM)

RM 250

2. RECOVERY KEY

RM 50

HAVANA Series



COLOUR

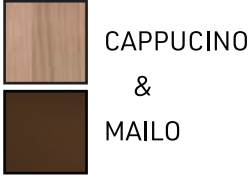

PRODUCT SPECIFICATION

MAIN TABLE OF-HAVANA-01

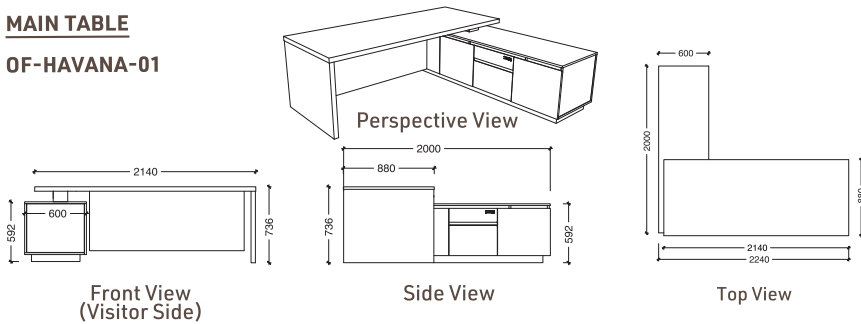

CABINET OF-HAVANA-02

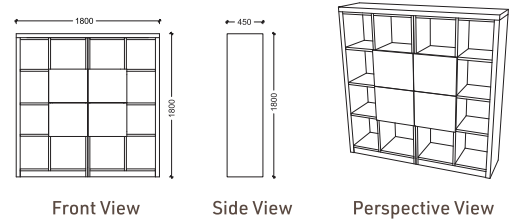

TECHNICAL SPECIFICATION

Executive Desk & Integral Storage Unit

L-Configuration (available in left and right models)

Width	Depth	Height (mm)	Description
Left hand			Attached side storage consists of - a. two drawers with combination lock b. two swing door cabinet, finger pull doors, soft close feature
2240	2000	750	
Right hand			
2240	2000	750	

Table top thickness = 43mm

Material	Model	Price
Melamine Faced Chipboard	OF-HAVANA-L-01	RM 2,988
	OF-HAVANA-R-01	

High Storage

Freestanding storage cabinet, four-tier

Width	Depth	Height (mm)	Description
1800	450	1800	Four-tier open bookcase with four swing doors, finger pull doors, soft-close feature

Material	Model	Price
Melamine Faced Chipboard	OF-HAVANA-02	RM 2,488

Optional	Model	Price
1. 	1. WRITING PAD W700 * D500 * 1.2 THK (MM)	RM 250
2. 	2. RECOVERY KEY	RM 50

VENETO Series



COLOUR

MARBLE WHITE



LANDEN



MAILO



PRODUCT SPECIFICATION

MAIN TABLE

OF-VENETO-01

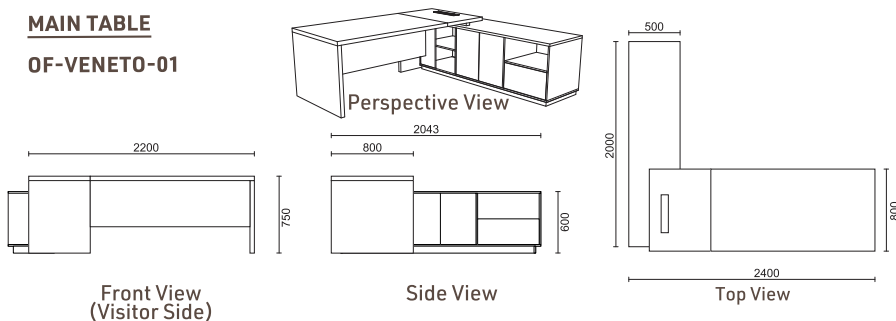

CABINET

OF-VENETO-02

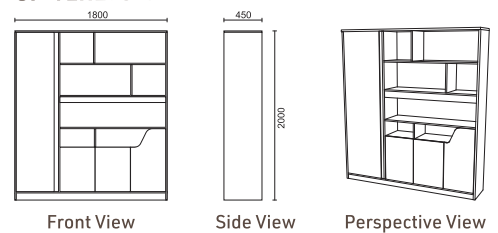

TECHNICAL SPECIFICATION

Executive Desk & Integral Storage Unit

L-Configuration (available in left and right models)

Width	Depth	Height (mm)	Description
Left hand			Attached side storage consists of - a. open drawer with lock b. swing door cabinet c. open shelf *push to open doors, soft-close feature
2400	2043	750	
Right hand			Two Sides Sliding Socket 2 X UK Power, 1 X Universal Power, 1 X HDMI + 1 X CAT 6
2400	2043	750	
Table top thickness = 43mm			
Material Melamine Faced Chipboard			
Model OF-VENETO-01-L			
OF-VENETO-01-R			
RM 3,688			

Medium Storage

Freestanding storage cabinet, finger pull doors

Width	Depth	Height (mm)	Description
1800	450	2000	swing door cabinet and open shelf, soft-close feature
Material Melamine Faced Chipboard			
Model OF-VENETO-02			
RM 2,488			

KREST Series



COLOUR

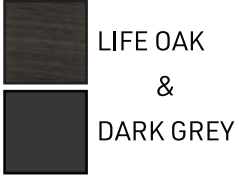

PRODUCT SPECIFICATION

MAIN TABLE

OF-KREST-2121 |
OF-KREST-2422

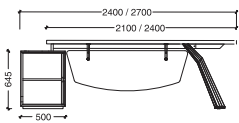
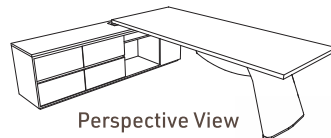

Front View
(Visitor Side)

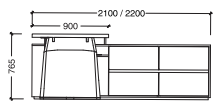

Side View

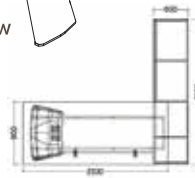

Top View

CABINET

OFP-SW-90210 | OFP-OS-90210 | OFP-FSGC-90210

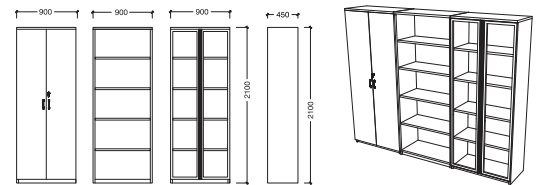

Front View

Side View

Perspective View

TECHNICAL SPECIFICATION

Executive Desk & Integral Storage Unit

L-Configuration (available in left and right models)

Width	Depth	Height (mm)
<i>Left / Right hand</i>		
2100	2100	750
<i>Left / Right hand</i>		
2400	2200	750

Table top thickness = 40mm

Material
High Pressure Laminate (HPL)

Melamine Faced Chipboard +
Metal leg

Description
Attached side storage consists of -
a. four soft close drawer
b. open shelf finger pull door, flip up cover for socket outlets

Model	Price
OF-KREST-2121	RM 5,388
OF-KREST-2422	RM 5,588

Medium Storage

Freestanding storage cabinet, finger pull doors

Width	Depth	Height (mm)
900	450	2100
900	450	2100
900	450	2100

Material
Melamine Faced
Chipboard

Description
a.High Swing Door Cabinet
b.High Open Shelf Cabinet
c.High Full Glass Cabinet

Model	Price
a) OFP-SW-90210	RM 1,098
b) OFP-OS-90210	RM 828
c) OFP-FSGC-90210	RM 1,788

DENVER

Series



COLOUR

RENNER WALNUT
&
DM SAGE



PRODUCT SPECIFICATION

MAIN TABLE

OF-DENVER-01

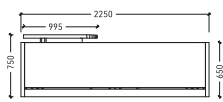

Front View
(Visitor Side)

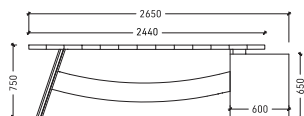

Side View

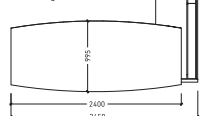

Top View

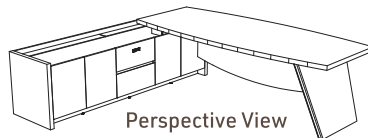

Perspective View

CABINET

OF-DENVER-02

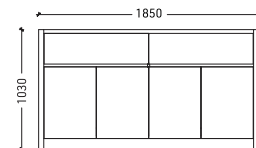

Front View

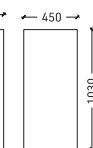

Side View

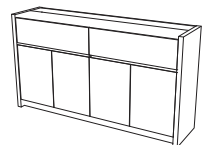

Perspective View

TECHNICAL SPECIFICATION

Executive Desk & Integral Storage Unit

L-Configuration (available in left and right models)

Width	Depth	Height (mm)
Left hand		
2650	2364	750
Right hand		
2650	2364	750

Table top thickness = 43mm

Material
Melamine Faced Chipboard

Description
Attached side storage consists of -
a. two drawers with combination lock
b. three swing door cabinet, finger pull doors, soft-close feature

Model
OF-DENVER-L-01 **RM 3,988**
OF-DENVER-R-01

Medium Storage

Freestanding storage cabinet, finger pull doors

Width	Depth	Height (mm)
1850	450	1030

Material
Melamine Faced
Chipboard

Optional

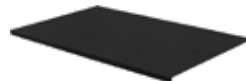

Description
Four swing door cabinet and 2 drawers, soft-close feature

Model
OF-DENVER-02 **RM 2,388**

Model
WRITING PAD **RM 250**
W700 * D500 * 1.2 THK (MM)

VORTEX

Series



workspace of TOMORROW

COLOUR



CASABLANCA

&



DARK GREY



PRODUCT SPECIFICATION

MAIN TABLE

OF-VORTEX-01

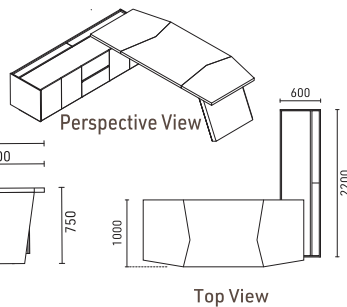
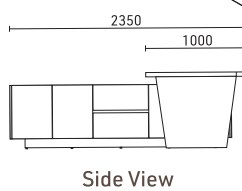
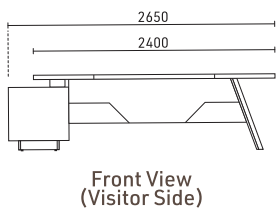

CABINET

OF-VORTEX-02

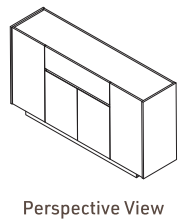
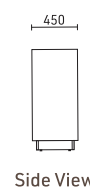
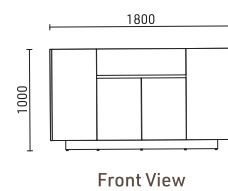

TECHNICAL SPECIFICATION

Executive Desk & Integral Storage Unit

L-Configuration (available in left and right models)

	Width	Depth	Height (mm)
Left hand			
	2650	2200	750
Right hand			
	2650	2200	750

Table top thickness = 43mm

Material

Melamine Faced
Chipboard

Description

Attached side storage consists of -
a. two drawers
b. three swing door cabinet,
finger pull doors, flip up cover
for socket outlets

Model

OF-VORTEX-L-01

RM 3,288

OF-VORTEX-R-01

Medium Storage

Freestanding storage cabinet, finger pull doors

	Width	Depth	Height (mm)
	1800	450	1000

Material

Melamine Faced
Chipboard

Optional



Description

Center drawer and swing door cabinet,
soft-close feature

Model

OF-VORTEX-02

RM 1,418

Model

WRITING PAD

W700 * D500 * 1.2 THK (MM)

RM 250

EVOKE Series



COLOUR

CAFE LATTE
&
DARK GREY



PRODUCT SPECIFICATION

MAIN TABLE

OF-EVOKE-01

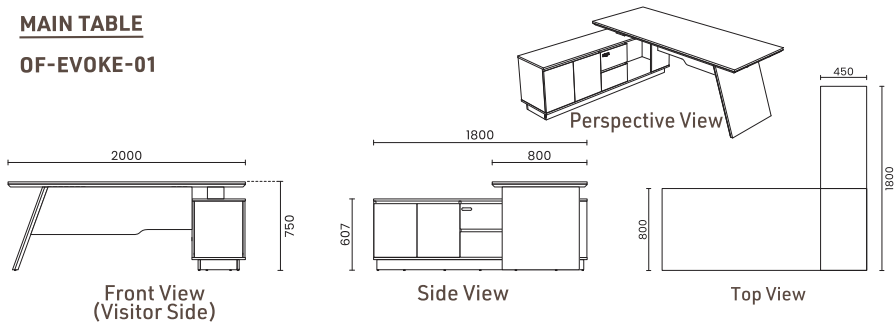

CABINET

OF-EVOKE-02

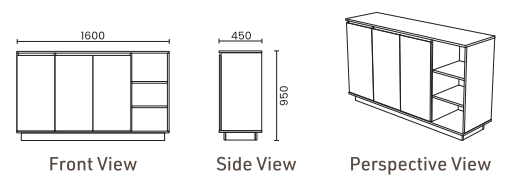

TECHNICAL SPECIFICATION

Executive Desk & Integral Storage Unit

L-Configuration (available in left and right models)

Width	Depth	Height (mm)
<i>Left / Right hand</i>		
2000	1800	750
<i>Left / Right hand</i>		
2000	1800	750

Table top thickness = 43mm

Material
Melamine Faced Chipboard

Description
Attached side storage consists of -
a. two drawers with lock
b. swing door cabinet
c. open shelf, finger pull doors, soft-close feature

Model
OF-EVOKE-L-01 **RM 2,488**
OF-EVOKE-R-01

Medium Storage

Freestanding storage cabinet, finger pull doors

Width	Depth	Height (mm)
1600	450	950

Material
Melamine Faced Chipboard



Description
Swing door cabinet and open shelf, soft-close feature

Model
OF-EVOKE-02 **RM 1,228**

Model
1. WRITING PAD **RM 250**
W700 * D500 * 1.2 THK (MM)
2. RECOVERY KEY **RM 50**

LUTZ Series



COLOUR



HAMPSHIRE WALNUT

&



WHITE



PRODUCT SPECIFICATION

MAIN TABLE

OF-LUTZ-01

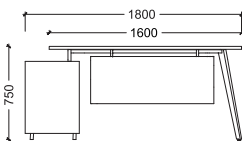

Front View
(Visitor Side)

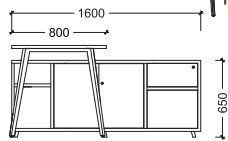

Side View

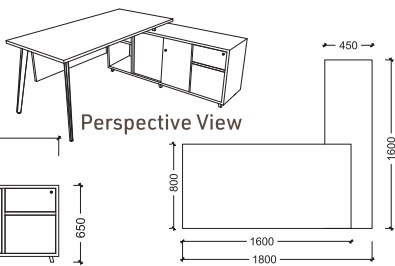

Perspective View

Top View

CABINET

OF-LUTZ-02

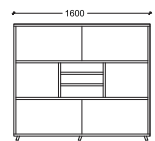

Front View



Side View



Perspective View

TECHNICAL SPECIFICATION

Executive Desk & Integral Storage Unit

L-Configuration (available in left and right models)

Width	Depth	Height (mm)
<i>Left hand</i>		
1800	1600	750
<i>Right hand</i>		
1800	1600	750

Table top thickness = 18mm (chamfered edging)

Material

Melamine Faced Chipboard

Description

Attached side storage consists of -
a. two drawers with lock
b. two sliding doors cabinet
c. open shelf

Model

OF-LUTZ-L-01

RM 1,988

OF-LUTZ-R-01

Medium Storage

Freestanding storage cabinet, finger pull doors

Width	Depth	Height (mm)
1600	400	1316

Material

Melamine Faced Chipboard

Description

Three-tier open bookcase with two sliding doors

Model

OF-LUTZ-02

RM 1,288

ALEXIS Series



COLOUR

WALNUT 2.0
&
WHITE



PRODUCT SPECIFICATION

MAIN TABLE OF-ALEXIS-01

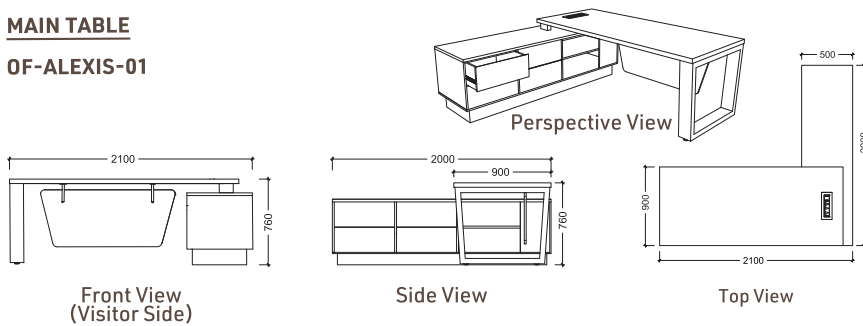

CABINET

OF-SWG-80X125 + OF-SDC-80X85 |
OF-SWG-80X125 + OF-SDDC-80X85 | OF-OSC-160X85

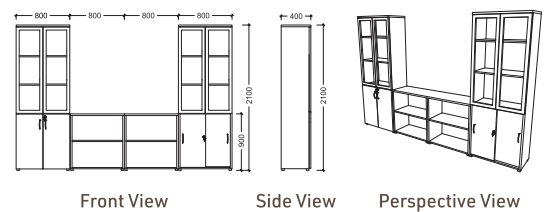

TECHNICAL SPECIFICATION

Executive Desk & Integral Storage Unit

L-Configuration (available in left and right models)

Width	Depth	Height (mm)
Left hand		
2100	2000	760
Right hand		
2100	2000	760

Table top thickness = 41 mm

Material

Melamine Faced
Chipboard + Metal leg

Description

Attached side storage consists of -
a. four drawers with lock
b. open shelf cabinet

* Netbox turn (2 power socket
boxes, 2 USB ports,
telephone, Lan ports.)



Model

OF-ALEXIS-L-01

RM 3,288

OF-ALEXIS-R-01

Medium Storage

Freestanding storage cabinet, finger pull doors

Width	Depth	Height (mm)
800	400	2100
800	400	2100
1600	400	850

Material

Melamine Faced
Chipboard

Description

a. high swing glass + swing door cabinet
b. high swing glass + sliding door cabinet
c. low open shelf cabinet

Model

**a. OF-SWG-80X125 +
OF-SDC-80X85**

RM 1,548

**b. OF-SWG-80X125 +
OF-SDDC-80X85**

RM 1,668

c. OF-OSC-160X85

RM 698

LATTICE

Series



COLOUR



SAPPLE
&
BLACK



PRODUCT SPECIFICATION

MAIN TABLE

OF-LATTICE-01

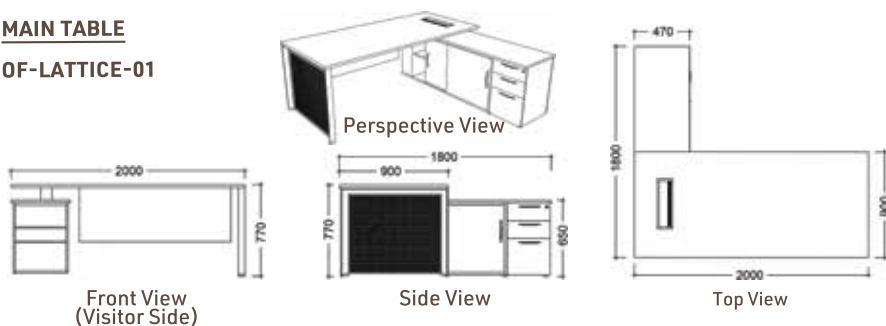

CABINET

OF-LA-W-210 | OF-LA-H-210 | OF-LA-O-210

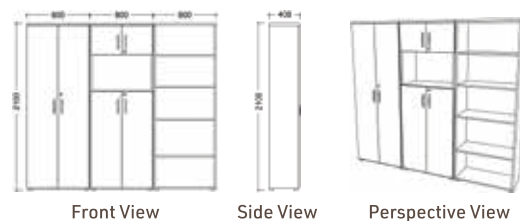

TECHNICAL SPECIFICATION

Executive Desk & Integral Storage Unit

L-Configuration (available in left and right models)

Width	Depth	Height (mm)
<i>Left hand</i>		
2000	1800	770
<i>Right hand</i>		
2000	1800	770

Table top thickness = 41 mm

Material

Melamine Faced Chipboard

Description

Attached side storage consists of -

- three drawers with lock
- 2 sliding doors cabinet
- open shelf

Model

OF-LATTICE-L-01

RM 2,488

OF-LATTICE-R-01

Medium Storage

Freestanding storage cabinet, finger pull doors

Width	Depth	Height (mm)
800	400	2100
800	400	2100
800	400	2100

Material

Melamine Faced
Chipboard

Description

- high swing door storage
- high executive storage
- high open storage

Model

OF-LA-W-210

RM 1,248

OF-LA-H-210

RM 1,148

OF-LA-O-210

RM 718

Model

WRITING PAD

W700 * D500 * 1.2 THK (MM)

RM 250

Optional



MAVEN Series



COLOUR

FAGGIONA
&
GRAPHITE



PRODUCT SPECIFICATION

MAIN TABLE OF-MAVEN-01

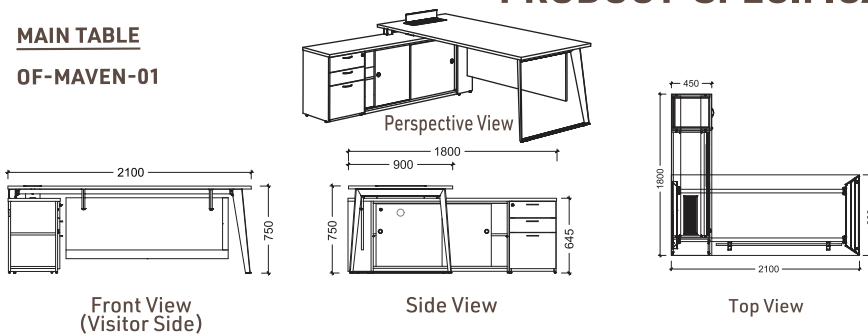

CABINET OF-MAVEN-02

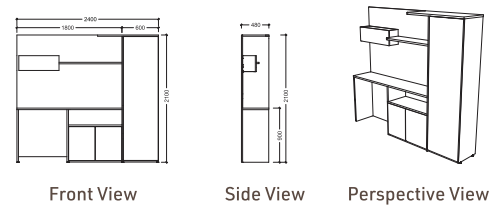

TECHNICAL SPECIFICATION

Executive Desk & Integral Storage Unit

L-Configuration (available in left and right models)

Width	Depth	Height (mm)
<i>Left hand</i>		
2100	1800	750
<i>Right hand</i>		
2100	1800	750

Table top thickness = 25mm

Material

Melamine Faced
Chipboard

Description

Attached side storage consists of -
a. three drawers with lock
b. 2 sliding door cabinet
c. open shelf

Model

OF-MAVEN-L-01

OF-MAVEN-R-01

RM 2,588

High Storage

Freestanding storage cabinet

Width	Depth	Height (mm)
2400	480	2100

Material

Melamine Faced
Chipboard

Description

- one wardrobe swing door with 2 adjustable shelf a suspended clothes bar
- 2 swing doors cabinet
- planter box

Model

OF-MAVEN-02

RM 3,138

ARCHER Series



COLOUR



PRODUCT SPECIFICATION

MAIN TABLE

OF-ARCHER-01

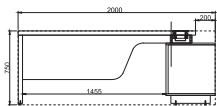
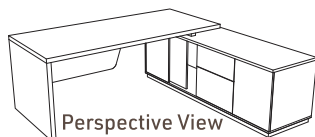

Front View
(Visitor Side)

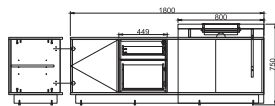

Side View

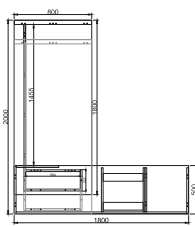

Top View

CABINET

OF-ARC-SWG-90210 | OF-ARC-SW-90210 |
OF-ARC-OS-90210

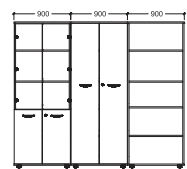

Front View



Side View



Perspective View

TECHNICAL SPECIFICATION

Executive Desk & Integral Storage Unit

L-Configuration (available in left and right models)

Width	Depth	Height (mm)
<i>Left hand</i>		
1800/2000	800/500	750
<i>Right hand</i>		
1800/2000	800/500	750

Table top thickness = 43mm

Material

Melamine Faced
Chipboard

Description

Attached side storage consists of -
a. two drawers with key lock
b. two sliding door cabinet without lock
c. single swing door cabinet without lock
finger pull doors, soft close feature

Model

OF-ARCHER-L-01

RM3,288

OF-ARCHER-R-01

High Storage

Freestanding storage cabinet

Width	Depth	Height (mm)
900	450	2100
900	450	2100
900	450	2100

Material

Melamine Faced
Chipboard

Description

a) Book Shelf Cabinet c/w Glass Door
b) High Swing Door Cabinet
c) High Open Shelf Cabinet

Model

a) OF-ARC-SWG-90210

RM 1,428

b) OF-ARC-SW-90210

RM 1,008

c) OF-ARC-OS-90210

RM 748



MENSA 88 Series

MENSA 88-24
Director Table with Metal Leg (Top 41mm thk)
W2400*D1000*H750 mm

RM 3,118

MENSA 88-21
Director Table with Metal Leg (Top 41mm thk)
W2100*D900*H750 mm

RM 2,888



MENSA 66 Series

MENSA 66-24
Director Table with Metal Leg (Top 41mm thk)
W2400*D1000*H750 mm

RM 3,118

MENSA 66-21
Director Table with Metal Leg (Top 41mm thk)
W2100*D900*H750 mm

RM 2,888



MENSA 55 Series

MENSA 55-24
Director Table c/w Side Cabinet with Chrome Frame
W2400(1000)*D2100(450)*H750 mm

RM 4,288

MENSA 55-21
Director Table c/w Side Cabinet with Chrome Frame
W2100(900)*D2100(450)*H750 mm

RM 4,078

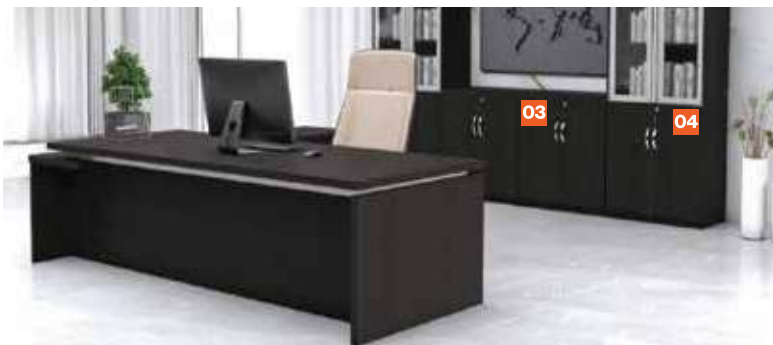

MENSA 52 Series

MENSA 52-24
Director Table with Side Cabinet (Top 41mm thk)
W2400(1000)*D2400(500)*H750 mm

RM 2,898

MENSA 52-21
Director Table with Side Cabinet (Top 41mm thk)
W2100(900)*D2100(500)*H750 mm

RM 2,608

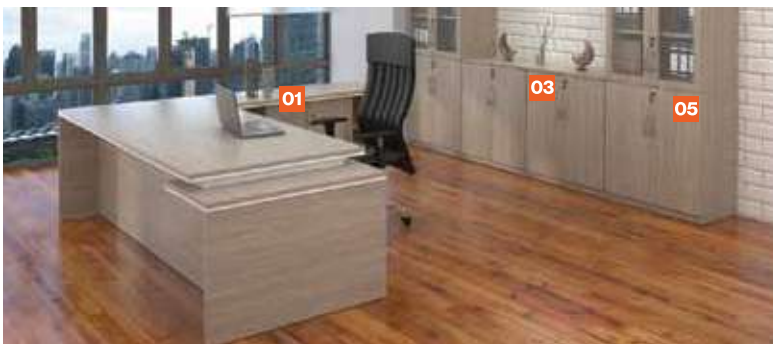

MENSA 32 Series

MENSA 32-24
Director Table (Top 41mm thk)
W2400*D1000*H750 mm

RM 2,128

MENSA 32-21
Director Table (Top 41mm thk)
W2100*D900*H750 mm

RM 1,848

STORAGE

01 MARS 320-DC
Director Side Cabinet
W1400*D500*H750 mm

RM 738

02 MARS-3D
Mobile Pedestal 3D
W410*D500*H560 mm

RM 348

03 MARS-LC
Low Swinging Door Cabinet c/w Base
W800*D450*H900 mm

RM 478

04 MARS-AF
Half Glass Cabinet with Base c/w Aluminium Frame
W800*D450*H2100 mm

RM 1,048

05 MARS-WF
Half Glass Cabinet with Base c/w Wooden Frame
W800*D400*H2110 mm

RM 1,048



BELTON Series



OF-BELTON-01
Director Table c/w Double Side Cabinet
W2400(900)*D1815(500)*H766 mm

RM 2,688



ALVA Series



OF-ALVA-01
Director Table c/w Single Side Cabinet
W1800(900)*D1815(500)*H766 mm

RM 1,988



CAPRI Series



OF-CAPRI 2462
Director Table c/w Open Shelf + Sliding Door + Fixed Pedestal 1D1F (Top 41thk)
W2307(850)*D1800(450)*H766 mm

RM 1,998

OF-CAPRI 2463
Director Table c/w Open Shelf + Sliding Door + Fixed Pedestal 3D (Top 41thk)
W2307(850)*D1800(450)*H766 mm

RM 1,998



SEN II Series



OF-SEN II 2162
Director Table c/w Open Shelf + Sliding Door + Fixed Pedestal 1D1F (Top 25thk)
W2160(900)*D1600(450)*H750 mm

RM 1,788

OF-SEN II 2163
Director Table c/w Open Shelf + Sliding Door + Fixed Pedestal 3D (Top 25thk)
W2160(900)*D1600(450)*H750 mm

RM 1,788



TENTRIX Series



01 OF-TX-1800 RM 888
Director Table (Top 41thk)
W1800*D900*H750 mm

01 OF-TX-2100 RM 988
Director Table (Top 41thk)
W2100*D900*H750 mm

02 OF-TX-SC RM 648
Fixed Pedestal 3D + Open Shelf + Swinging Door (R)
W1200*D450*H600 mm

03 OF-TX-M2D RM 268
Mobile Pedestal 1D1F
W400*D480*H560 mm

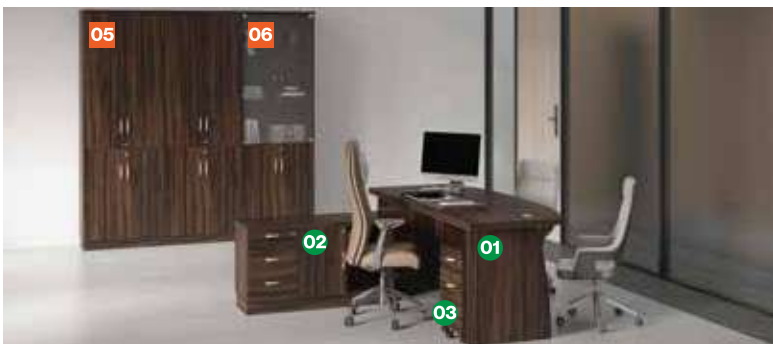

STORAGE

01 OF-BELTON-02 RM 1,188
Open Shelf + Sliding Door + Swinging Door High Cabinet (L)
W1200*D400*H2110 mm

04 OF-CP211-G1 RM 1,018
Wooden Frame Swinging Glass Door High Cabinet
W800*D400*H2110 mm

02 OF-BELTON-03 RM 888
Open Shelf + Sliding Door + High Cabinet (L)
W1200*D400*H2110 mm

05 OF-TX211-2D1 RM 868
Dual Swinging Door High Cabinet
W800*D400*H2110 mm

03 OF-CP-130-D1 RM 548
Swinging Door Medium Cabinet
W800*D400*H1310 mm

06 OF-TX211-G1 RM 878
Swinging Glass Door High Cabinet
W800*D400*H2110 mm

FARRANO Series



- 01 Director Table Set** **RM 2,168**
W2100*D1000*H750 mm
- 01 Director Table Set** **RM 1,888**
W1800*D900*H750 mm
- 02 Side Return Cabinet** **RM 1,218**
W1500*D600*H600 mm
- 02 Side Return Cabinet** **RM 1,128**
W1200*D600*H600 mm
- 03 High Back Cabinet** **RM 3,488**
W2250*D450*H1800 mm

Colour Option:



BEACON Series



- 01 BRI-MGR-BR01** **RM 2,588**
Brilliant L Shape Table
W1800/750*D2036/450*H750 mm
- 02 OF-MGR-SW-9H** **RM 458**
Medium High Swing Door Cabinet
W900*D450*H900 mm
- 03 OF-MGR-2SW-21H-2** **RM 1,248**
High 2 Tier Swing Door Cabinet
W900*D450*H2100 mm

Colour Option:



NARITA Series



- 01 OF-NARITA-01** **RM 1,488**
Ofis Director Set
W1800(800)*D1800(450)*H750 mm
- Colour:
-

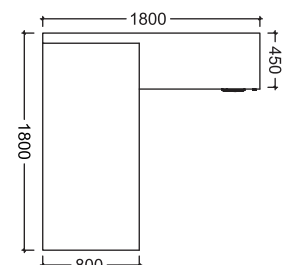

HEIGHT ADJUSTABLE DIRECTOR DESK SERIES

P
A
L
L
A
D
O



ADJUSTABLE HEIGHT

Transition between sitting and standing at the touch of a button.



RM 5,588

T
A
R
E
A

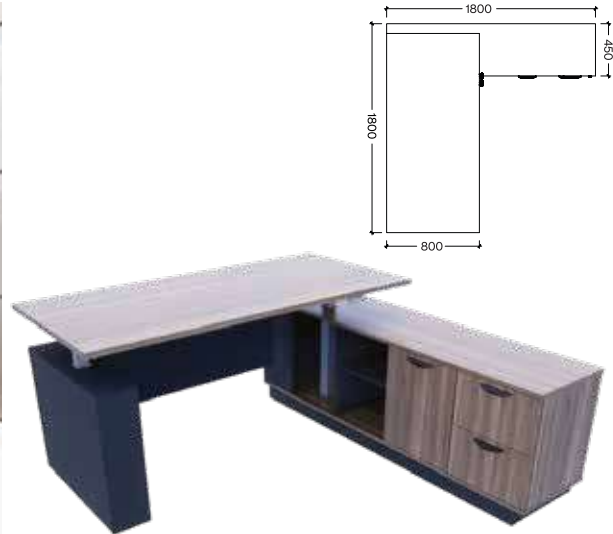

RM 3,988

V
I
R
A
N
A



MOTORIZED HEIGHT ADJUSTABLE LEG

Cluster of 2

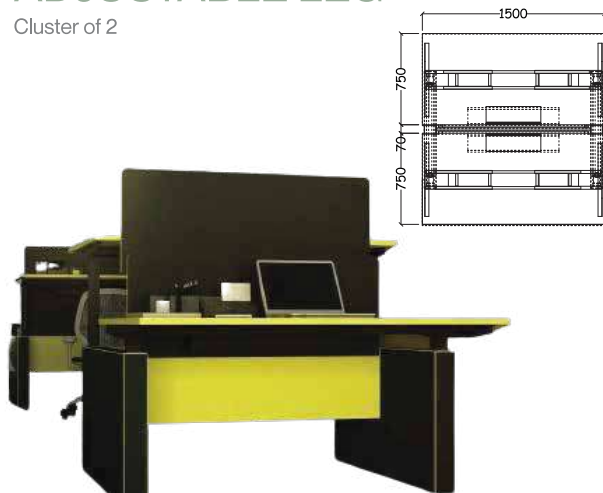

FROM RM 7,988

HEIGHT ADJUSTABLE DESK SERIES



HAND CRANK
2 STAGE - min 715mm, max 1145mm (Height),
speed 4mm / Crank turn
Loading Capacity - 80kgs
3 STAGE - min 605mm, max 1245mm (Height),
speed 5mm / Crank turn
Loading Capacity - 80kgs



ELECTRIC
2 STAGE - min 725mm, max 1155mm (Height),
speed 28mm per sec
Loading capacity - 120kgs
3 STAGE - min 615mm, max 1255mm (Height),
speed 38mm per sec
Loading Capacity - 120kgs



Colour options:

- Teak
- Black
- Beech
- White
- L.Grey
- Maple
- Cherry



SINGLE WORKSTATION

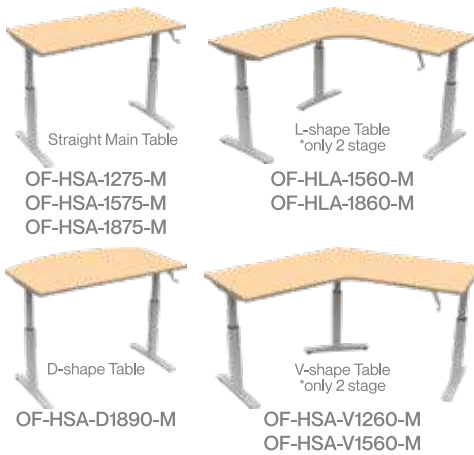

DOUBLE WORKSTATION



MEDICAL OVERBED DESK



SINGLE COLUMN WALL DESK



CONFERENCE TABLE

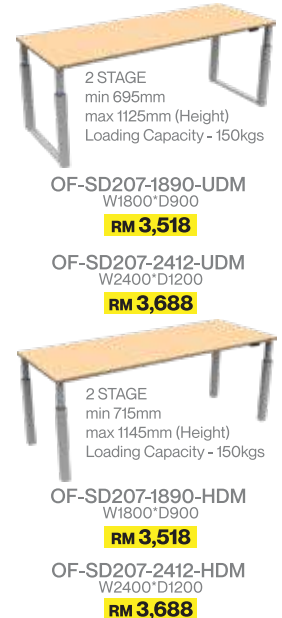

HAND CRANK		
MODEL	SIZE	PRICE
T SERIES (ONLY 2 STAGE)		
OF-DSH24-1200C2	W1200*D750	RM 2,438
OF-DSH24-1500C2	W1500*D750	RM 2,498
OF-DSH24-1800C2	W1800*D750	RM 2,588
U SERIES (ONLY 2 STAGE)		
OF-DSH26-1200C2	W1200*D750	RM 2,588
OF-DSH26-1500C2	W1500*D750	RM 2,628
OF-DSH26-1800C2	W1800*D750	RM 2,698
H SERIES (ONLY 2 STAGE)		
OF-DSH12-1200C2	W1200*D750	RM 2,588
OF-DSH12-1500C2	W1500*D750	RM 2,628
OF-DSH12-1800C2	W1800*D750	RM 2,698

HAND CRANK			
MODEL	SIZE	PRICE	
		2 STAGES	3 STAGES
OF-HSA-1275-M	W1200*D750	RM 1,088	RM 1,258
OF-HSA-1575-M	W1500*D750	RM 1,118	RM 1,288
OF-HSA-1875-M	W1800*D750	RM 1,148	RM 1,328
OF-HSA-D1890-M	W1800*D750/900	RM 1,218	RM 1,348
OF-HLA-1560-M	W1500(600)*L1500(600)	RM 1,828	RM 1,988
OF-HLA-1860-M	W1800(600)*L1800(600)	RM 1,928	RM 2,088
OF-HSA-V1260-M	W1200(600)*L1200(600)	RM 1,938	RM 2,088
OF-HSA-V1560-M	W1500(600)*L1500(600)	RM 2,158	RM 2,288

ELECTRIC		
MODEL	SIZE	PRICE
T SERIES (ONLY 2 STAGE)		
OF-SD204-1200C2	W1200*D750	RM 4,148
OF-SD204-1500C2	W1500*D750	RM 4,198
OF-SD204-1800C2	W1800*D750	RM 4,258
U SERIES (ONLY 2 STAGE)		
OF-SD204-1200C2	W1200*D750	RM 4,278
OF-SD204-1500C2	W1500*D750	RM 4,338
OF-SD204-1800C2	W1800*D750	RM 4,398
H SERIES (ONLY 2 STAGE)		
OF-SD204-1200C2	W1200*D750	RM 3,938
OF-SD204-1500C2	W1500*D750	RM 3,998
OF-SD204-1800C2	W1800*D750	RM 4,058

ELECTRIC			
MODEL	SIZE	PRICE	
		2 STAGES	3 STAGES
OF-HSA-1275-E2	W1200*D750	RM 1,688	RM 1,898
OF-HSA-1575-E2	W1500*D750	RM 1,718	RM 1,928
OF-HSA-1875-E2	W1800*D750	RM 1,748	RM 1,968
OF-HSA-D1890-E2	W1800*D750/900	RM 1,828	RM 2,048
OF-HLA-1560-E2	W1500(600)*L1500(600)	RM 2,648	RM 2,828
OF-HLA-1860-E2	W1800(600)*L1800(600)	RM 2,748	RM 2,928
OF-HSA-V1260-E2	W1200(600)*L1200(600)	RM 2,758	RM 2,928
OF-HSA-V1560-E2	W1500(600)*L1500(600)	RM 2,978	RM 3,148

ACCESSORIES

SKELETON SNAKE CABLE
CM1 W20*D70*L1200 **RM 100 /set**

WIRE METAL RISER BOX
CB071 W23*D63*H450 **RM 100 /set**

DIY BOX (no grommet)
RM 180 /set

***For Height Adjustable Desk**
Cable Tray
CT112 W150*H100 **RM 290 /set**

T TOUCH
Anti-Collision Sensor
RM 120 /set

*Images provided are for illustration purposes only. *Prices quoted are subject to change without prior notice & while stocks last. *Terms & conditions apply. *While every care is taken in the preparation of this flyer any inaccuracy or omission is much regretted.

DESKING SYSTEM SERIES ACCESSORIES









FRAMELESS PANEL SERIES (WITHOUT BRACKET)

5mm thk Acrylic Panel with Solid Color Sticker - 300H		8mm thk Full Sandblasting Tempered Glass Panel - 300H		16mm thk Fabric Board with Chrome Line - 300H		18mm thk Fabric Board with Transparent Lining - 300H		Zolla Glass Whiteboard Panel - 300H	
									
COLOUR OPTION: RED / YELLOW / BLUE / GREEN / ORANGE / CLEAR / FROSTED									
0600W	RM 174	0600W	RM 199	0600W	RM 126	0600W	RM 141	0600W	RM 274
0900W	RM 228	0900W	RM 299	0900W	RM 147	0900W	RM 158	0900W	RM 349
1200W	RM 282	1200W	RM 357	1200W	RM 170	1200W	RM 174	1200W	RM415
1500W	RM 336	1500W	RM 432	1500W	RM 189	1500W	RM 199	1500W	RM 494
1800W	RM 386	1800W	RM 510	1800W	RM 211	1800W	RM 249	1800W	RM 581

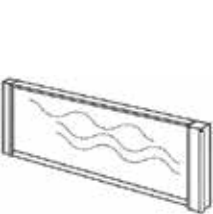
ALUMINIUM FRAME SERIES 20MM/28MM THK PANEL WITH ALUMINIUM FRAME HEIGHT 300H/400H (WITHOUT BRACKET)

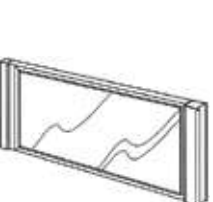
Frame Colour Option :

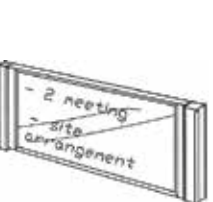

Chipboard Panel / Wood Panel 300mm (H)			Fabric Panel 300mm (H)			Clear Glass Panel / Full Glass Panel 300mm (H)			Polycarbonate Panel / Full Poly Panel 300mm (H)			Magnetic Whiteboard Panel 300mm (H) (Double Side)			Fabric Panel with Raceway 400mm (H) (28mm THK only)	
																
	20mm THK	28mm THK		20mm THK	28mm THK		20mm THK	28mm THK		20mm THK	28mm THK		20mm THK	28mm THK		28mm THK
0600W	RM 132	RM 133	0600W	RM 114	RM 137	0600W	RM 136	RM 141	0600W	RM 152	RM 152	0600W	RM216	RM 183	0600W	RM 249
0900W	RM 160	RM 162	0900W	RM 132	RM 145	0900W	RM 160	RM 162	0900W	RM 174	RM 174	0900W	RM 291	RM 241	0900W	RM 307
1200W	RM 189	RM 191	1200W	RM 152	RM 162	1200W	RM 180	RM 183	1200W	RM 198	RM 198	1200W	RM 354	RM 291	1200W	RM 365
1500W	RM 240	RM 220	1500W	RM 170	RM 174	1500W	RM 198	RM 208	1500W	RM 240	RM 240	1500W	RM 435	RM 340	1500W	RM 432
1800W	RM 260	RM 249	1800W	RM 189	RM 220	1800W	RM 218	RM 228	1800W	RM 268	RM 268	1800W	RM 502	RM 390	1800W	RM 523

OPEN PLAN SYSTEM SERIES ACCESSORIES

G BOARD SERIES



18mm THK G Wood Panel

Fits to 25mm THK desk tops as standard others available on request

18mm THK G Board with Bracket (Wood)			
For Table Depth	300H	400H	600H
0600D	RM 195	RM 212	RM 232
0750D	RM 208	RM 232	RM 257
0900D	RM 241	RM 266	RM 295

18mm THK G Board with Bracket (Fabric)			
For Table Depth	300H	400H	600H
0600D	RM 195	RM 212	RM 232
0750D	RM 208	RM 232	RM 257
0900D	RM 241	RM 266	RM 295



750H / 900H PANEL SERIES (WITHOUT BRACKET)

28mm THK Fabric Panel with Aluminium Frame			18mm THK Frameless Fabric Panel		
	750H	900H		750H	900H
600	RM 216	RM 232	600	RM 191	RM 208
750	RM 232	RM 241	900	RM 266	RM 291
900	RM 240	RM 257	1200	RM 340	RM 374
1050	RM 248	RM 274	1500	RM 380	RM 461
1200	RM 299	RM 315	1800	RM 461	RM 515
1350	RM 307	RM 332			
1500	RM 349	RM 374			
1650	RM 365	RM 390			
1800	RM 374	RM 398			

(300H) DIVIDER WOODEN SERIES (WITHOUT BRACKET)

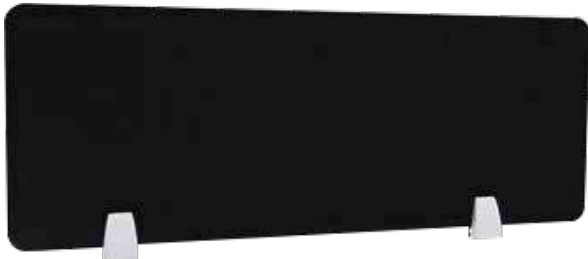

16mm Colour Option:



18mm Colour Option:



Divider Wooden Panel c/w Radius			
16mm (R50)		18mm (R30)	
600	RM 75	600	RM 107
750	RM 80	750	RM 107
900	RM 86	900	RM 107
1050	RM 92	1050	RM 130
1200	RM 100	1200	RM 165
1350	RM 115	1350	RM 228
1500	RM 125	1500	RM 228
1650	RM 140	1650	RM 245
1800	RM 150	1800	RM 245

Metal Modesty Panel TYPE A (c/w Bracket)	Metal L Modesty Panel TYPE B	Metal Modesty Panel TYPE C (c/w Bracket)	Wooden Modesty Panel (w/o Bracket)	T-Screen Panel TYPE 1 (w/o Bracket)																																								
<p>COLOUR OPTION: WHITE / BLACK only</p>	<p>COLOUR OPTION: WHITE / BLACK only</p>	<p>COLOUR OPTION: WHITE / SILVER / DARK GREY / BLACK</p>																																										
<table border="1"> <tr> <td>PT-MPMH77CL16 (W)775*(H)400*0.8 THK</td> <td>RM 100</td> </tr> <tr> <td>PT-MPMH107CL16 (W)1075*(H)400*0.8 THK</td> <td>RM 125</td> </tr> <tr> <td>PT-MPMH137CL16 (W)1375*(H)400*0.8 THK</td> <td>RM 150</td> </tr> </table>	PT-MPMH77CL16 (W)775*(H)400*0.8 THK	RM 100	PT-MPMH107CL16 (W)1075*(H)400*0.8 THK	RM 125	PT-MPMH137CL16 (W)1375*(H)400*0.8 THK	RM 150	<table border="1"> <tr> <td>PT-MPML90 (W)600*(H)420*0.8 THK</td> <td>RM 70</td> </tr> <tr> <td>PT-MPML120 (W)900*(H)420*0.8 THK</td> <td>RM 95</td> </tr> <tr> <td>PT-MPML150 (W)1200*(H)420*0.8 THK</td> <td>RM 110</td> </tr> <tr> <td>PT-MPML180 (W)1500*(H)420*0.8 THK</td> <td>RM 130</td> </tr> </table>	PT-MPML90 (W)600*(H)420*0.8 THK	RM 70	PT-MPML120 (W)900*(H)420*0.8 THK	RM 95	PT-MPML150 (W)1200*(H)420*0.8 THK	RM 110	PT-MPML180 (W)1500*(H)420*0.8 THK	RM 130	<table border="1"> <tr> <td>CT-MMP-1200 (W)1000*(H)450</td> <td>RM 140</td> </tr> <tr> <td>CT-MMP-1500 (W)1300*(H)450</td> <td>RM 160</td> </tr> <tr> <td>CT-MMP-1800 (W)1600*(H)450</td> <td>RM 200</td> </tr> </table>	CT-MMP-1200 (W)1000*(H)450	RM 140	CT-MMP-1500 (W)1300*(H)450	RM 160	CT-MMP-1800 (W)1600*(H)450	RM 200	<table border="1"> <tr> <td>OF-WMP-120 (W)1000*(H)450</td> <td>RM 100</td> </tr> <tr> <td>OF-WMP-150 (W)1300*(H)450</td> <td>RM 135</td> </tr> <tr> <td>OF-WMP-180 (W)1500*(H)450</td> <td>RM 155</td> </tr> <tr> <td>OF-WMP-210 (W)1800*(H)450</td> <td>RM 165</td> </tr> </table>	OF-WMP-120 (W)1000*(H)450	RM 100	OF-WMP-150 (W)1300*(H)450	RM 135	OF-WMP-180 (W)1500*(H)450	RM 155	OF-WMP-210 (W)1800*(H)450	RM 165	<table border="1"> <tr> <td>P-TSP-1060 (W)1000*(H)1600*18 THK</td> <td>RM 168</td> </tr> <tr> <td>P-TSP-1075 (W)1000*(H)1750*18 THK</td> <td>RM 208</td> </tr> <tr> <td>P-TSP-1360 (W)1300*(H)1600*18 THK</td> <td>RM 228</td> </tr> <tr> <td>P-TSP-1375 (W)1300*(H)1750*18 THK</td> <td>RM 298</td> </tr> <tr> <td>P-TSP-1670 (W)1600*(H)1600*18 THK</td> <td>RM 268</td> </tr> <tr> <td>P-TSP-1675 (W)1600*(H)1750*18 THK</td> <td>RM 348</td> </tr> </table>	P-TSP-1060 (W)1000*(H)1600*18 THK	RM 168	P-TSP-1075 (W)1000*(H)1750*18 THK	RM 208	P-TSP-1360 (W)1300*(H)1600*18 THK	RM 228	P-TSP-1375 (W)1300*(H)1750*18 THK	RM 298	P-TSP-1670 (W)1600*(H)1600*18 THK	RM 268	P-TSP-1675 (W)1600*(H)1750*18 THK	RM 348
PT-MPMH77CL16 (W)775*(H)400*0.8 THK	RM 100																																											
PT-MPMH107CL16 (W)1075*(H)400*0.8 THK	RM 125																																											
PT-MPMH137CL16 (W)1375*(H)400*0.8 THK	RM 150																																											
PT-MPML90 (W)600*(H)420*0.8 THK	RM 70																																											
PT-MPML120 (W)900*(H)420*0.8 THK	RM 95																																											
PT-MPML150 (W)1200*(H)420*0.8 THK	RM 110																																											
PT-MPML180 (W)1500*(H)420*0.8 THK	RM 130																																											
CT-MMP-1200 (W)1000*(H)450	RM 140																																											
CT-MMP-1500 (W)1300*(H)450	RM 160																																											
CT-MMP-1800 (W)1600*(H)450	RM 200																																											
OF-WMP-120 (W)1000*(H)450	RM 100																																											
OF-WMP-150 (W)1300*(H)450	RM 135																																											
OF-WMP-180 (W)1500*(H)450	RM 155																																											
OF-WMP-210 (W)1800*(H)450	RM 165																																											
P-TSP-1060 (W)1000*(H)1600*18 THK	RM 168																																											
P-TSP-1075 (W)1000*(H)1750*18 THK	RM 208																																											
P-TSP-1360 (W)1300*(H)1600*18 THK	RM 228																																											
P-TSP-1375 (W)1300*(H)1750*18 THK	RM 298																																											
P-TSP-1670 (W)1600*(H)1600*18 THK	RM 268																																											
P-TSP-1675 (W)1600*(H)1750*18 THK	RM 348																																											

• Images provided are for illustration purposes only. • Prices quoted are subject to change without prior notice & while stocks last. • Terms & conditions apply. • While every care is taken in the preparation of this flyer any inaccuracy or omission is much regretted.

OPEN PLAN SYSTEM SERIES ACCESSORIES



Manual Rotary Socket
2 x Power Socket Boxes
2 x USB ports
1 x telephone
1 x LAN port

RM 450



Table Recess Console (TR)
1 x 16amp On/Off Switch
3 x 13amp UK power socket
1 x usb + 1 x tel + 1 x cat6 + 1 x blank insert
Come with 2.5m cable cord

RM 658



Keyboard Tray

RM 85



Two Sides Sliding Socket
2 x UK power
1 x Universal Power
1 x HDMI + 1 x CAT6

RM 300



Sliding Socket with Wireless Charger
2 x UK power
1 x Universal Power
1 x HDMI + 1 x CAT6
1 x wireless charger

RM 470



PVC Cable Riser
(U-PT-SC)
(SILVER)
725MM HEIGHT

RM 85



Skeleton Snake
(PT-CM1)
(DARK GREY)

1 METER: RM 85
1.2 METER: RM 100



MODEL	PRICE
3 GANG FLIPPER COVER	RM 100
4 GANG FLIPPER COVER	RM 120
6 GANG FLIPPER COVER	RM 150



SIZE	PRICE
L301- L450 * W150 MM	RM 100
L451- L600 * W150 MM	RM 120



MODEL	PRICE
L301- L450 * W150 MM (SINGLE)	RM 120
L451- L600 * W150 MM (SINGLE)	RM 135
L301- L450 * W300 MM (DOUBLE)	RM 240
L451- L600 * W300 MM (DOUBLE)	RM 270



MODEL	SIZE	PRICE
OF-OWR-650 (FIX IN UNDER NOVA LEG)	W200 * D50 * H650 MM	RM 180
OF-OWR-725 (FIX IN UNDER TABLE TOP)	W200 * D50 * H725 MM	RM 200



Aluminium Cable Hatch
3 Gang / 4 Gang

RM 150 RM 180



Aluminium Cable Hatch
6 Gang

RM 220



Wooden Socket Box with Hinge-Typed Cover

L450 * W150 * H150 MM **RM 320**
L600 * W150 * H150 MM **RM 468**



AH Mayer Netbox TUM Comfort Socket Box
(4 Socket Outlet 6B) (Retardant Properties)

RM 988



Double Side
Bottom Wire Trunking 4 Gang

RM 180



Single Side
Bottom Wire Trunking 4 Gang

RM 150



Metal Wire Tray

L600 * W150 * H100 MM **RM 130**



Wire Tray
(L800 MM)

RM 200



Connecting Plate

RM 15



Fixed CPU Trolley
(Black)

RM 200



Fixed CPU Holder
(Black)

RM 160



Metal Stiffener
W900 MM **RM 50**
W1200 MM **RM 60**
W1500 MM **RM 70**



Angle Bar
For Wooden Modesty Panel
(L420 MM)

RM 55/pair



T-Bracket
For Wooden Modesty Panel

RM 70/pair



Grommet Cap

RM 10



Hanging Panel Bracket

RM 50/pair



Optimus Clip Bracket (OCB)

RM 46



Optimus Single Bracket (OCBS)

RM 45



Optimus Double Bracket (OCBD)

RM 45



Acrylic Top Bracket (ARCB-T)

RM 18



Acrylic Center Bracket (ARCB-D)

RM 18



Acrylic Single Bracket (ARCB-S)

RM 18



KREST

Leg Colour



GRAPHITE

Colour Option



HORNSEY PEAR
(CELTIC ASH)



CAFE OAK
(LIFE OAK)



CABOSSA OAK
(OAK PEGASUS)



ALVA MAPLE
(LADINIA)

ITEM	HEIGHT (W*D*H)(mm)	PRICE
OF-KREST-3615	3600*1500*750	RM 7,388
OF-KREST-4815	4800*1500*750	RM 9,238
OF-KREST-6015	6000*1500*750	RM 9,998

Technical Specification

40mm T HPL laminate top joint in **ASSORTED COLOUR**. Curvature metal leg in **EPOXY GRAPHITE**. Wooden wire riser in **MFC GRAPHITE**

Perspective View



OF-KREST-3615



OF-KREST-4815



OF-KREST-6015



BOARDROOM TABLE SERIES



JAVA

Colour Option



HORNSEY PEAR
(CELTIC ASH)



CAFE OAK
(LIFE OAK)



CABOSSA OAK
(OAK PEGASUS)



ALVA MAPLE
(LADINIA)

ITEM	HEIGHT (W*D*H)(mm)	PRICE
OF-JAVA-3615	3600*1500*750	RM 7,188
OF-JAVA-4815	4800*1500*750	RM 8,058
OF-JAVA-5415	5400*1500*750	RM 9,488
OF-JAVA-6015	6000*1500*750	RM 9,968
OF-JAVA-7215	7200*1500*750	RM 11,968
OF-JAVA-7815	7800*1500*750	RM 12,688
OF-JAVA-8415	8400*1500*750	RM 12,968

Technical Specification

40mm T HPL laminate top joint in **ASSORTED COLOUR**. Include wire management. Wooden flipper on **BLACK LEATHER** finished.

Perspective View



OF-JAVA-3615



OF-JAVA-4815

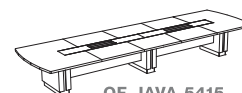

OF-JAVA-5415

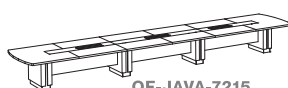

OF-JAVA-7215

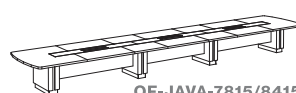

OF-JAVA-7815/8415

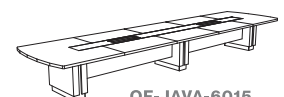

OF-JAVA-6015

SUMMIT

Colour Option

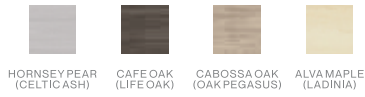

Technical Specification

40mm THPL laminate top joint in ASSORTED COLOUR with MFC box leg

	DIY BOX	HEIGHT (W*D*H)(mm)	PRICE		DIY BOX	HEIGHT (W*D*H)(mm)	PRICE
OF-SUMMIT-2412	1	2400*1200*750	RM 2,688	OF-SUMMIT-7512	4	7500*1200*750	RM 8,328
OF-SUMMIT-3012	2	3000*1200*750	RM 4,328	OF-SUMMIT-8412	4	8400*1200*750	RM 8,498
OF-SUMMIT-3612	2	3600*1200*750	RM 4,498	OF-SUMMIT-3015	2	3000*1500*750	RM 5,998
OF-SUMMIT-4512	2	4500*1200*750	RM 4,918	OF-SUMMIT-4515	2	4500*1500*750	RM 7,668
OF-SUMMIT-5412	3	5400*1200*750	RM 6,088	OF-SUMMIT-5415	3	5400*1500*750	RM 9,498
OF-SUMMIT-6012	3	6000*1200*750	RM 6,328	OF-SUMMIT-6615	4	6600*1500*750	RM 11,328

BOARDROOM TABLE SERIES



ROXI

Leg Colour



Colour Option

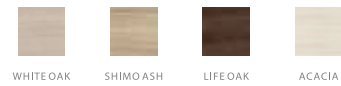

Technical Specification

25mm THK melamine laminated chipboard in ASSORTED COLOUR metal J leg in D. GREY COLOUR

Perspective View

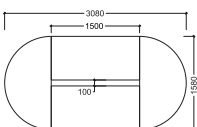

OF-ROXI-308X158
W3080*D1580*H750 mm

RM 2,578

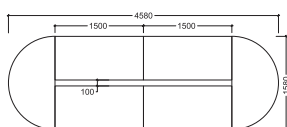

OF-ROXI-458X158
W4580*D1580*H750 mm

RM 3,828

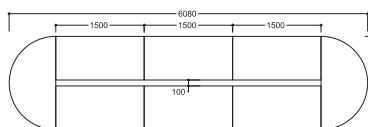

OF-ROXI-608X158
W6080*D1580*H750 mm

RM 5,038

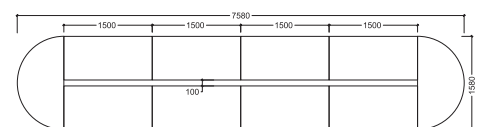

OF-ROXI-758X158
W7580*D1580*H750 mm

RM 6,268



BEACON

Colour Option



Leg Colour



Top Shapes

RECTANGLE

**WITHOUT
SOCKET BOX**

ITEM	HEIGHT (W*D*H)(mm)	PRICE
OF-BEACON-1890	1800*900*750	RM 1,288
OF-BEACON-3012-WR	3000*1200*750	RM 2,688
OF-BEACON-3015-WR	3000*1500*750	RM 2,788
OF-BEACON-4512-WR	4500*1200*750	RM 3,838
OF-BEACON-4515-WR	4500*1500*750	RM 3,988

*WR = WIRE RISE

Technical Specification

25mm THK melamine laminated chipboard in **ASSORTED COLOUR**. Powder coated metal leg in **COFFEE**.



BOARDROOM TABLE SERIES



MAVEN

Colour Option



Leg Colour



Top Shapes

RECTANGLE

**WITHOUT
SOCKET BOX**

ITEM	HEIGHT (W*D*H)(mm)	PRICE
OF-MAVEN-1890	1800*900*750	RM 1,288
OF-MAVEN-2190	2100*900*750	RM 1,348
OF-MAVEN-3012-WR	3000*1200*750	RM 2,388
OF-MAVEN-3012	4500*1200*750	RM 2,608
OF-MAVEN-4512-WR	4500*1200*750	RM 3,328

*WR = WIRE RISE

ITEM	HEIGHT (W*D*H)(mm)	PRICE
OF-MAVEN-4512	4500*1200*750	RM 3,728
OF-MAVEN-3015-WR	3000*1500*750	RM 2,898
OF-MAVEN-3015	3000*1500*750	RM 3,068
OF-MAVEN-4515-WR	4500*1500*750	RM 4,148
OF-MAVEN-4515	4500*1500*750	RM 4,388

*WR = WIRE RISE

Technical Specification

25mm THK melamine laminated chipboard in **ASSORTED COLOUR**. Angular metal leg in **BLACK**.

MILA

WITHOUT SOCKET BOX

Leg Colour



Colour Option

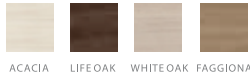

Top Shapes

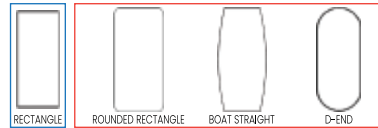

Technical Specifications

25mm THK melamine laminated chipboard in ASSORTED COLOUR. 50mm x 50mm metal leg in ASSORTED COLOUR.

RECTANGULAR ML LEG CONFERENCE TABLE

MODEL	DIMENSION (W*D*H)(mm)	PRICE
OF-ML-RC-1890	1800*900*750	RM 888
OF-ML-RC-2412	2400*1200*750	RM 1,228

OVAL & BOAT ML LEG CONFERENCE TABLE

MODEL	DIMENSION (W*D*H)(mm)	PRICE
OF-ML-OC-1890 / OF-ML-BC-1890	1800*900*750	RM 968
OF-ML-OC-2412 / OF-ML-BC-2412	2400*1200*750	RM 1,318

RECTANGULAR ML LEG CONFERENCE TABLE * WITH WIRE RISER

MODEL	DIMENSION (W*D*H)(mm)	PRICE
OF-ML-RC-3012	3000*1200*750	RM 1,988
OF-ML-RC-3612	3600*1200*750	RM 2,108
OF-ML-RC-4812	4800*1200*750	RM 2,288
OF-ML-RC-3015	3000*1500*750	RM 2,108
OF-ML-RC-3615	3600*1500*750	RM 2,288
OF-ML-RC-4815	4800*1500*750	RM 2,448

RECTANGULAR ML LEG CONFERENCE TABLE * WITH WIRE RISER

MODEL	DIMENSION (W*D*H)(mm)	PRICE
OF-ML-RC-WR-3012	3000*1200*750	RM 2,138
OF-ML-RC-WR-3612	3600*1200*750	RM 2,248
OF-ML-RC-WR-4812	4800*1200*750	RM 2,428
OF-ML-RC-WR-3015	3000*1500*750	RM 2,248
OF-ML-RC-WR-3615	3600*1500*750	RM 2,428
OF-ML-RC-WR-4815	4800*1500*750	RM 2,598

OVAL & BOAT ML LEG CONFERENCE TABLE * WITHOUT WIRE RISER

MODEL	DIMENSION (W*D*H)(mm)	PRICE
OF-ML-OC-3012 / OF-ML-BC-3012	3000*1200*750	RM 2,198
OF-ML-OC-3612 / OF-ML-BC-3612	3600*1200*750	RM 2,338
OF-ML-OC-4812 / OF-ML-BC-4812	4800*1200*750	RM 2,528
OF-ML-OC-3015 / OF-ML-BC-3015	3000*1500*750	RM 2,308
OF-ML-OC-3615 / OF-ML-BC-3615	3600*1500*750	RM 2,428
OF-ML-OC-4815 / OF-ML-BC-4815	4800*1500*750	RM 2,618

OVAL & BOAT ML LEG CONFERENCE TABLE * WITH WIRE RISER

MODEL	DIMENSION (W*D*H)(mm)	PRICE
OF-ML-OC-WR-3012 / OF-ML-BC-WR-3012	3000*1200*750	RM 2,338
OF-ML-OC-WR-3612 / OF-ML-BC-WR-3612	3600*1200*750	RM 2,478
OF-ML-OC-WR-4812 / OF-ML-BC-WR-4812	4800*1200*750	RM 2,678
OF-ML-OC-WR-3015 / OF-ML-BC-WR-3015	3000*1500*750	RM 2,458
OF-ML-OC-WR-3615 / OF-ML-BC-WR-3615	3600*1500*750	RM 2,578
OF-ML-OC-WR-4815 / OF-ML-BC-WR-4815	4800*1500*750	RM 2,768



BOARDROOM TABLE SERIES

LOOP

WITHOUT SOCKET BOX

Leg Colour



Colour Option

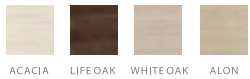

Top Shapes

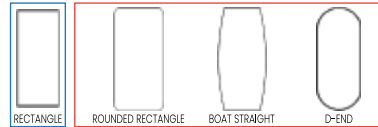

Technical Specifications

25mm THK melamine laminated chipboard in ASSORTED COLOUR. 75mm x 25mm a metal leg in EPOXY ASSORTED COLOUR.

RECTANGULAR LP LEG CONFERENCE TABLE

MODEL	DIMENSION (W*D*H)(mm)	PRICE
OF-LP-RC-1890	1800*900*750	RM 988
OF-LP-RC-2412	2400*1200*750	RM 1,328

OVAL & BOAT LP LEG CONFERENCE TABLE

MODEL	DIMENSION (W*D*H)(mm)	PRICE
OF-LP-OC-1890 / OF-LP-BC-1890	1800*900*750	RM 1,058
OF-LP-OC-2412 / OF-LP-BC-2412	2400*1200*750	RM 1,418

RECTANGULAR LP LEG CONFERENCE TABLE * WITHOUT WIRE RISER

MODEL	DIMENSION (W*D*H)(mm)	PRICE
OF-LP-RC-3012	3000*1200*750	RM 1,958
OF-LP-RC-3612	3600*1200*750	RM 2,068
OF-LP-RC-4812	4800*1200*750	RM 2,228
OF-LP-RC-3015	3000*1500*750	RM 2,128
OF-LP-RC-3615	3600*1500*750	RM 2,288
OF-LP-RC-4815	4800*1500*750	RM 2,468

RECTANGULAR LP LEG CONFERENCE TABLE * WITH WIRE RISER

MODEL	DIMENSION (W*D*H)(mm)	PRICE
OF-LP-RC-WR-3012	3000*1200*750	RM 2,028
OF-LP-RC-WR-3612	3600*1200*750	RM 2,128
OF-LP-RC-WR-4812	4800*1200*750	RM 2,288
OF-LP-RC-WR-3015	3000*1500*750	RM 2,188
OF-LP-RC-WR-3615	3600*1500*750	RM 2,328
OF-LP-RC-WR-4815	4800*1500*750	RM 2,488

OVAL & BOAT LP LEG CONFERENCE TABLE * WITHOUT WIRE RISER

MODEL	DIMENSION (W*D*H)(mm)	PRICE
OF-LP-OC-3012 / OF-LP-BC-3012	3000*1200*750	RM 2,138
OF-LP-OC-3612 / OF-LP-BC-3612	3600*1200*750	RM 2,268
OF-LP-OC-4812 / OF-LP-BC-4812	4800*1200*750	RM 2,448
OF-LP-OC-3015 / OF-LP-BC-3015	3000*1500*750	RM 2,298
OF-LP-OC-3615 / OF-LP-BC-3615	3600*1500*750	RM 2,408
OF-LP-OC-4815 / OF-LP-BC-4815	4800*1500*750	RM 2,588

OVAL & BOAT LP LEG CONFERENCE TABLE * WITH WIRE RISER

MODEL	DIMENSION (W*D*H)(mm)	PRICE
OF-LP-OC-WR-3012 / OF-LP-BC-WR-3012	3000*1200*750	RM 2,208
OF-LP-OC-WR-3612 / OF-LP-BC-WR-3612	3600*1200*750	RM 2,338
OF-LP-OC-WR-4812 / OF-LP-BC-WR-4812	4800*1200*750	RM 2,518
OF-LP-OC-WR-3015 / OF-LP-BC-WR-3015	3000*1500*750	RM 2,358
OF-LP-OC-WR-3615 / OF-LP-BC-WR-3615	3600*1500*750	RM 2,468
OF-LP-OC-WR-4815 / OF-LP-BC-WR-4815	4800*1500*750	RM 2,638



NOVA

WITHOUT SOCKET BOX

Leg Colour



Colour Option



Top Shapes

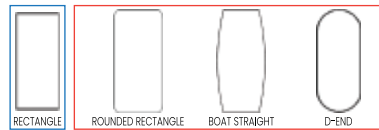

RECTANGULAR NV LEG CONFERENCE TABLE * WITHOUT WIRE RISER

MODEL	DIMENSION (W*D*H)(mm)	PRICE
OF-NV-RC-3012	3000*1200*750	RM 1,928
OF-NV-RC-3612	3600*1200*750	RM 2,048
OF-NV-RC-4812	4800*1200*750	RM 2,228
OF-NV-RC-3015	3000*1500*750	RM 2,048
OF-NV-RC-3615	3600*1500*750	RM 2,228
OF-NV-RC-4815	4800*1500*750	RM 2,388

RECTANGULAR NV LEG CONFERENCE TABLE * WITH WIRE RISER

MODEL	DIMENSION (W*D*H)(mm)	PRICE
OF-NV-RC-WR-3012	3000*1200*750	RM 2,078
OF-NV-RC-WR-3612	3600*1200*750	RM 2,188
OF-NV-RC-WR-4812	4800*1200*750	RM 2,368
OF-NV-RC-WR-3015	3000*1500*750	RM 2,188
OF-NV-RC-WR-3615	3600*1500*750	RM 2,368
OF-NV-RC-WR-4815	4800*1500*750	RM 2,538

OVAL & BOAT NV LEG CONFERENCE TABLE * WITHOUT WIRE RISER

MODEL	DIMENSION (W*D*H)(mm)	PRICE
OF-NV-OC-3012 / OF-NV-BC-3012	3000*1200*750	RM 2,138
OF-NV-OC-3612 / OF-NV-BC-3612	3600*1200*750	RM 2,278
OF-NV-OC-4812 / OF-NV-BC-4812	4800*1200*750	RM 2,468
OF-NV-OC-3015 / OF-NV-BC-3015	3000*1500*750	RM 2,248
OF-NV-OC-3615 / OF-NV-BC-3615	3600*1500*750	RM 2,368
OF-NV-OC-4815 / OF-NV-BC-4815	4800*1500*750	RM 2,558

OVAL & BOAT NV LEG CONFERENCE TABLE * WITH WIRE RISER

MODEL	DIMENSION (W*D*H)(mm)	PRICE
OF-NV-OC-WR-3012 / OF-NV-BC-WR-3012	3000*1200*750	RM 2,278
OF-NV-OC-WR-3612 / OF-NV-BC-WR-3612	3600*1200*750	RM 2,418
OF-NV-OC-WR-4812 / OF-NV-BC-WR-4812	4800*1200*750	RM 2,618
OF-NV-OC-WR-3015 / OF-NV-BC-WR-3015	3000*1500*750	RM 2,398
OF-NV-OC-WR-3615 / OF-NV-BC-WR-3615	3600*1500*750	RM 2,518
OF-NV-OC-WR-4815 / OF-NV-BC-WR-4815	4800*1500*750	RM 2,698

Technical Specifications

25mm THK melamine laminated chipboard in ASSORTED COLOUR. 50mm x 50mm metal leg in ASSORTED COLOUR.

RECTANGULAR NV LEG CONFERENCE TABLE

MODEL	DIMENSION (W*D*H)(mm)	PRICE
OF-NV-RC-1890	1800*900*750	RM 868
OF-NV-RC-2412	2400*1200*750	RM 1,198

OVAL & BOAT NV LEG CONFERENCE TABLE

MODEL	DIMENSION (W*D*H)(mm)	PRICE
OF-NV-OC-1890 / OF-NV-BC-1890	1800*900*750	RM 948
OF-NV-OC-2412 / OF-NV-BC-2412	2400*1200*750	RM 1,288



BOARDROOM TABLE SERIES



MITRA

WITHOUT SOCKET BOX

Leg Colour



Colour Option

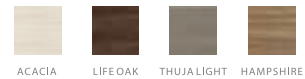

Top Shapes

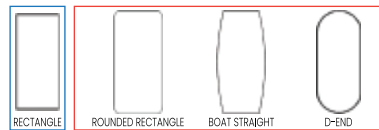

RECTANGULAR LEG CONFERENCE TABLE * WITHOUT WIRE RISER

MODEL	DIMENSION (W*D*H)(mm)	PRICE
OF-MI-RC-3012	3000*1200*750	RM 2,048
OF-MI-RC-3612	3600*1200*750	RM 2,188
OF-MI-RC-4812	4800*1200*750	RM 2,388
OF-MI-RC-3015	3000*1500*750	RM 2,168
OF-MI-RC-3615	3600*1500*750	RM 2,388
OF-MI-RC-4815	4800*1500*750	RM 2,588

RECTANGULAR LEG CONFERENCE TABLE * WITH WIRE RISER

MODEL	DIMENSION (W*D*H)(mm)	PRICE
OF-MI-RC-WR-3012	3000*1200*750	RM 2,288
OF-MI-RC-WR-3612	3600*1200*750	RM 2,388
OF-MI-RC-WR-4812	4800*1200*750	RM 2,588
OF-MI-RC-WR-3015	3000*1500*750	RM 2,388
OF-MI-RC-WR-3615	3600*1500*750	RM 2,498
OF-MI-RC-WR-4815	4800*1500*750	RM 2,698

OVAL & BOAT LEG CONFERENCE TABLE * WITHOUT WIRE RISER

MODEL	DIMENSION (W*D*H)(mm)	PRICE
OF-MI-OC-3012 / OF-MI-BC-3012	3000*1200*750	RM 2,288
OF-MI-OC-3612 / OF-MI-BC-3612	3600*1200*750	RM 2,398
OF-MI-OC-4812 / OF-MI-BC-4812	4800*1200*750	RM 2,598
OF-MI-OC-3015 / OF-MI-BC-3015	3000*1500*750	RM 2,388
OF-MI-OC-3615 / OF-MI-BC-3615	3600*1500*750	RM 2,488
OF-MI-OC-4815 / OF-MI-BC-4815	4800*1500*750	RM 2,698

OVAL & BOAT LEG CONFERENCE TABLE * WITH WIRE RISER

MODEL	DIMENSION (W*D*H)(mm)	PRICE
OF-MI-OC-WR-3012 / OF-MI-BC-WR-3012	3000*1200*750	RM 2,398
OF-MI-OC-WR-3612 / OF-MI-BC-WR-3612	3600*1200*750	RM 2,588
OF-MI-OC-WR-4812 / OF-MI-BC-WR-4812	4800*1200*750	RM 2,788
OF-MI-OC-WR-3015 / OF-MI-BC-WR-3015	3000*1500*750	RM 2,498
OF-MI-OC-WR-3615 / OF-MI-BC-WR-3615	3600*1500*750	RM 2,688
OF-MI-OC-WR-4815 / OF-MI-BC-WR-4815	4800*1500*750	RM 2,888

Technical Specifications

25mm THK melamine laminated chipboard in ASSORTED COLOUR. 50mm x 50mm metal leg in ASSORTED COLOUR.

RECTANGULAR FZ LEG CONFERENCE TABLE

MODEL	DIMENSION (W*D*H)(mm)	PRICE
OF-MI-RC-1890	1800*900*750	RM 1,028
OF-MI-RC-2412	2400*1200*750	RM 1,328

OVAL & BOAT FZ LEG CONFERENCE TABLE

MODEL	DIMENSION (W*D*H)(mm)	PRICE
OF-MI-OC-1890 / OF-MI-BC-1890	1800*900*750	RM 1,098
OF-MI-OC-2412 / OF-MI-BC-2412	2400*1200*750	RM 1,398

XIA

WITHOUT SOCKET BOX

Leg Colour

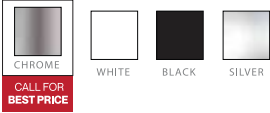

Colour Option

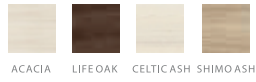

Top Shapes

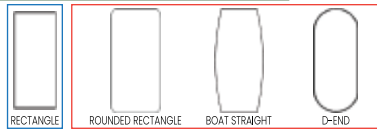

Technical Specifications

25mm THK melamine laminated chipboard in **ASSORTED COLOUR**. Steel leg in **ASSORTED COLOUR**.

RECTANGULAR IX LEG CONFERENCE TABLE		
MODEL	DIMENSION (W*D*H)(mm)	PRICE
OF-IX-R-1890	1800*900*750	RM 1,138
OF-IX-R-2412	2400*1200*750	RM 1,398

OVAL & BOAT IX LEG CONFERENCE TABLE		
MODEL	DIMENSION (W*D*H)(mm)	PRICE
OF-IX-O-1890 / OF-IX-BC-1890	1800*900*750	RM 1,198
OF-IX-O-2412 / OF-IX-BC-2412	2400*1200*750	RM 1,488



RECTANGULAR IX LEG CONFERENCE TABLE * WITHOUT WIRE RISER		
MODEL	DIMENSION (W*D*H)(mm)	PRICE
OF-IX-R-3012	3000*1200*750	RM 2,258
OF-IX-R-3612	3600*1200*750	RM 2,368
OF-IX-R-4812	4800*1200*750	RM 2,538
OF-IX-R-3015	3000*1500*750	RM 2,358
OF-IX-R-3615	3600*1500*750	RM 2,518
OF-IX-R-4815	4800*1500*750	RM 2,688

OVAL & BOAT IX LEG CONFERENCE TABLE * WITHOUT WIRE RISER		
MODEL	DIMENSION (W*D*H)(mm)	PRICE
OF-IX-O-3012 / OF-IX-BC-3012	3000*1200*750	RM 2,438
OF-IX-O-3612 / OF-IX-BC-3612	3600*1200*750	RM 2,588
OF-IX-O-4812 / OF-IX-BC-4812	4800*1200*750	RM 2,758
OF-IX-O-3015 / OF-IX-BC-3015	3000*1500*750	RM 2,538
OF-IX-O-3615 / OF-IX-BC-3615	3600*1500*750	RM 2,658
OF-IX-O-4815 / OF-IX-BC-4815	4800*1500*750	RM 2,838

RECTANGULAR IX LEG CONFERENCE TABLE * WITH WIRE RISER		
MODEL	DIMENSION (W*D*H)(mm)	PRICE
OF-IX-RC-WR-3012	3000*1200*750	RM 2,288
OF-IX-RC-WR-3612	3600*1200*750	RM 2,398
OF-IX-RC-WR-4812	4800*1200*750	RM 2,568
OF-IX-RC-WR-3015	3000*1500*750	RM 2,388
OF-IX-RC-WR-3615	3600*1500*750	RM 2,538
OF-IX-RC-WR-4815	4800*1500*750	RM 2,708

OVAL & BOAT IX LEG CONFERENCE TABLE * WITH WIRE RISER		
MODEL	DIMENSION (W*D*H)(mm)	PRICE
OF-IX-O-WR-3012 / OF-IX-BC-WR-3012	3000*1200*750	RM 2,468
OF-IX-O-WR-3612 / OF-IX-BC-WR-3612	3600*1200*750	RM 2,608
OF-IX-O-WR-4812 / OF-IX-BC-WR-4812	4800*1200*750	RM 2,788
OF-IX-O-WR-3015 / OF-IX-BC-WR-3015	3000*1500*750	RM 2,558
OF-IX-O-WR-3615 / OF-IX-BC-WR-3615	3600*1500*750	RM 2,668
OF-IX-O-WR-4815 / OF-IX-BC-WR-4815	4800*1500*750	RM 2,858



BOARDROOM TABLE SERIES

SMILE

WITHOUT SOCKET BOX

Leg Colour



Colour Option

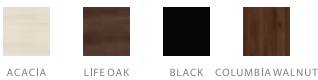

Top Shapes

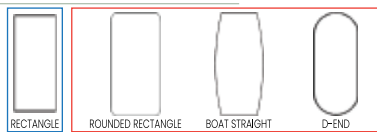

Technical Specifications

25mm THK melamine laminated chipboard in **ASSORTED COLOUR**. Steel leg in **ASSORTED COLOUR**.

RECTANGULAR SM LEG CONFERENCE TABLE		
MODEL	DIMENSION (W*D*H)(mm)	PRICE
OF-SM-RC-1890	1800*900*750	RM 968
OF-SM-RC-2412	2400*1200*750	RM 1,218

OVAL & BOAT SM LEG CONFERENCE TABLE		
MODEL	DIMENSION (W*D*H)(mm)	PRICE
OF-SM-OC-1890 / OF-SM-BC-1890	1800*900*750	RM 1,038
OF-SM-OC-2412 / OF-SM-BC-2412	2400*1200*750	RM 1,298



RECTANGULAR SM LEG CONFERENCE TABLE * WITHOUT WIRE RISER		
MODEL	DIMENSION (W*D*H)(mm)	PRICE
OF-SM-RC-3012	3000*1200*750	RM 1,878
OF-SM-RC-3612	3600*1200*750	RM 1,958
OF-SM-RC-4812	4800*1200*750	RM 2,078
OF-SM-RC-3015	3000*1500*750	RM 2,148
OF-SM-RC-3615	3600*1500*750	RM 2,288
OF-SM-RC-4815	4800*1500*750	RM 2,408

OVAL & BOAT SM LEG CONFERENCE TABLE * WITHOUT WIRE RISER		
MODEL	DIMENSION (W*D*H)(mm)	PRICE
OF-SM-OC-3012 / OF-SM-BC-3012	3000*1200*750	RM 2,058
OF-SM-OC-3612 / OF-SM-BC-3612	3600*1200*750	RM 2,168
OF-SM-OC-4812 / OF-SM-BC-4812	4800*1200*750	RM 2,308
OF-SM-OC-3015 / OF-SM-BC-3015	3000*1500*750	RM 2,338
OF-SM-OC-3615 / OF-SM-BC-3615	3600*1500*750	RM 2,418
OF-SM-OC-4815 / OF-SM-BC-4815	4800*1500*750	RM 2,558

RECTANGULAR SM LEG CONFERENCE TABLE * WITH WIRE RISER		
MODEL	DIMENSION (W*D*H)(mm)	PRICE
OF-SM-RC-WR-3012	3000*1200*750	RM 2,148
OF-SM-RC-WR-3612	3600*1200*750	RM 2,228
OF-SM-RC-WR-4812	4800*1200*750	RM 2,348
OF-SM-RC-WR-3015	3000*1500*750	RM 2,298
OF-SM-RC-WR-3615	3600*1500*750	RM 2,428
OF-SM-RC-WR-4815	4800*1500*750	RM 2,528

OVAL & BOAT SM LEG CONFERENCE TABLE * WITH WIRE RISER		
MODEL	DIMENSION (W*D*H)(mm)	PRICE
OF-SM-OC-WR-3012 / OF-SM-BC-WR-3012	3000*1200*750	RM 2,328
OF-SM-OC-WR-3612 / OF-SM-BC-WR-3612	3600*1200*750	RM 2,428
OF-SM-OC-WR-4812 / OF-SM-BC-WR-4812	4800*1200*750	RM 2,568
OF-SM-OC-WR-3015 / OF-SM-BC-WR-3015	3000*1500*750	RM 2,478
OF-SM-OC-WR-3615 / OF-SM-BC-WR-3615	3600*1500*750	RM 2,568
OF-SM-OC-WR-4815 / OF-SM-BC-WR-4815	4800*1500*750	RM 2,698



NISTRA II

WITHOUT SOCKET BOX

Leg Colour

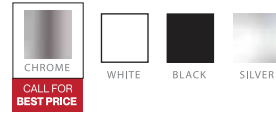

Colour Option



Top Shapes

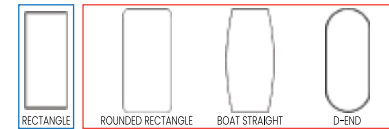

Technical Specifications

25mm THK melamine laminated chipboard in ASSORTED COLOUR. Steelleg in ASSORTED COLOUR.

RECTANGULAR NT LEG CONFERENCE TABLE * WITHOUT WIRE RISER

MODEL	DIMENSION (W*D*H)(mm)	PRICE
OF-NTII-RC-3012	3000*1200*750	RM 2,048
OF-NTII-RC-3612	3600*1200*750	RM 2,188
OF-NTII-RC-4812	4800*1200*750	RM 2,388
OF-NTII-RC-3015	3000*1500*750	RM 2,168
OF-NTII-RC-3615	3600*1500*750	RM 2,388
OF-NTII-RC-4815	4800*1500*750	RM 2,588

RECTANGULAR NT LEG CONFERENCE TABLE * WITH WIRE RISER

MODEL	DIMENSION (W*D*H)(mm)	PRICE
OF-NTII-RC-WR-3012	3000*1200*750	RM 2,288
OF-NTII-RC-WR-3612	3600*1200*750	RM 2,388
OF-NTII-RC-WR-4812	4800*1200*750	RM 2,588
OF-NTII-RC-WR-3015	3000*1500*750	RM 2,388
OF-NTII-RC-WR-3615	3600*1500*750	RM 2,448
OF-NTII-RC-WR-4815	4800*1500*750	RM 2,698

OVAL & BOAT NT LEG CONFERENCE TABLE * WITHOUT WIRE RISER

MODEL	DIMENSION (W*D*H)(mm)	PRICE
OF-NTII-OC-3012 / OF-NTII-BC-3012	3000*1200*750	RM 2,288
OF-NTII-OC-3612 / OF-NTII-BC-3612	3600*1200*750	RM 2,398
OF-NTII-OC-4812 / OF-NTII-BC-4812	4800*1200*750	RM 2,598
OF-NTII-OC-3015 / OF-NTII-BC-3015	3000*1500*750	RM 2,388
OF-NTII-OC-3615 / OF-NTII-BC-3615	3600*1500*750	RM 2,488
OF-NTII-OC-4815 / OF-NTII-BC-4815	4800*1500*750	RM 2,698

OVAL & BOAT NT LEG CONFERENCE TABLE * WITH WIRE RISER

MODEL	DIMENSION (W*D*H)(mm)	PRICE
OF-NTII-OC-WR-3012 / OF-NTII-BC-WR-3012	3000*1200*750	RM 2,398
OF-NTII-OC-WR-3612 / OF-NTII-BC-WR-3612	3600*1200*750	RM 2,588
OF-NTII-OC-WR-4812 / OF-NTII-BC-WR-4812	4800*1200*750	RM 2,788
OF-NTII-OC-WR-3015 / OF-NTII-BC-WR-3015	3000*1500*750	RM 2,498
OF-NTII-OC-WR-3615 / OF-NTII-BC-WR-3615	3600*1500*750	RM 2,688
OF-NTII-OC-WR-4815 / OF-NTII-BC-WR-4815	4800*1500*750	RM 2,888

RECTANGULAR NT LEG CONFERENCE TABLE

MODEL	DIMENSION (W*D*H)(mm)	PRICE
OF-NTII-RC-1890	1800*900*750	RM 1,028
OF-NTII-RC-2412	2400*1200*750	RM 1,328

OVAL & BOAT NT LEG CONFERENCE TABLE

MODEL	DIMENSION (W*D*H)(mm)	PRICE
OF-NTII-OC-1890 / OF-NTII-BC-1890	1800*900*750	RM 1,098
OF-NTII-OC-2412 / OF-NTII-BC-2412	2400*1200*750	RM 1,398



BOARDROOM TABLE SERIES



FUZE

WITHOUT SOCKET BOX

Leg Colour

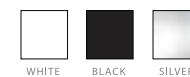

Colour Option

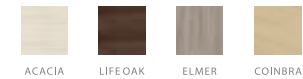

Top Shapes

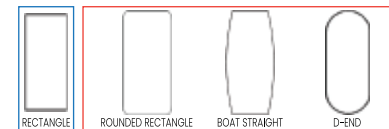

Technical Specifications

25mm THK melamine laminated chipboard in ASSORTED COLOUR. 75mm x 25mm metalleg in ASSORTED COLOUR.

RECTANGULAR LEG CONFERENCE TABLE * WITHOUT WIRE RISER

MODEL	DIMENSION (W*D*H)(mm)	PRICE
OF-FZ-RC-3012	3000*1200*750	RM 2,068
OF-FZ-RC-3612	3600*1200*750	RM 2,188
OF-FZ-RC-4812	4800*1200*750	RM 2,418
OF-FZ-RC-3015	3000*1500*750	RM 2,128
OF-FZ-RC-3615	3600*1500*750	RM 2,298
OF-FZ-RC-4815	4800*1500*750	RM 2,538

RECTANGULAR LEG CONFERENCE TABLE * WITH WIRE RISER

MODEL	DIMENSION (W*D*H)(mm)	PRICE
OF-FZ-RC-WR-3012	3000*1200*750	RM 2,168
OF-FZ-RC-WR-3612	3600*1200*750	RM 2,268
OF-FZ-RC-WR-4812	4800*1200*750	RM 2,498
OF-FZ-RC-WR-3015	3000*1500*750	RM 2,248
OF-FZ-RC-WR-3615	3600*1500*750	RM 2,418
OF-FZ-RC-WR-4815	4800*1500*750	RM 2,658

OVAL & BOAT LEG CONFERENCE TABLE * WITHOUT WIRE RISER

MODEL	DIMENSION (W*D*H)(mm)	PRICE
OF-FZ-OC-3012 / OF-FZ-BC-3012	3000*1200*750	RM 2,258
OF-FZ-OC-3612 / OF-FZ-BC-3612	3600*1200*750	RM 2,388
OF-FZ-OC-4812 / OF-FZ-BC-4812	4800*1200*750	RM 2,648
OF-FZ-OC-3015 / OF-FZ-BC-3015	3000*1500*750	RM 2,318
OF-FZ-OC-3615 / OF-FZ-BC-3615	3600*1500*750	RM 2,438
OF-FZ-OC-4815 / OF-FZ-BC-4815	4800*1500*750	RM 2,688

OVAL & BOAT LEG CONFERENCE TABLE * WITH WIRE RISER

MODEL	DIMENSION (W*D*H)(mm)	PRICE
OF-FZ-OC-WR-3012 / OF-FZ-BC-WR-3012	3000*1200*750	RM 2,338
OF-FZ-OC-WR-3612 / OF-FZ-BC-WR-3612	3600*1200*750	RM 2,488
OF-FZ-OC-WR-4812 / OF-FZ-BC-WR-4812	4800*1200*750	RM 2,728
OF-FZ-OC-WR-3015 / OF-FZ-BC-WR-3015	3000*1500*750	RM 2,438
OF-FZ-OC-WR-3615 / OF-FZ-BC-WR-3615	3600*1500*750	RM 2,558
OF-FZ-OC-WR-4815 / OF-FZ-BC-WR-4815	4800*1500*750	RM 2,798

RECTANGULAR FZ LEG CONFERENCE TABLE

MODEL	DIMENSION (W*D*H)(mm)	PRICE
OF-FZ-RC-1890	1800*900*750	RM 988
OF-FZ-RC-2412	2400*1200*750	RM 1,368

OVAL & BOAT FZ LEG CONFERENCE TABLE

MODEL	DIMENSION (W*D*H)(mm)	PRICE
OF-FZ-OC-1890 / OF-FZ-BC-1890	1800*900*750	RM 1,048
OF-FZ-OC-2412 / OF-FZ-BC-2412	2400*1200*750	RM 1,448



VISTA

WITHOUT SOCKET BOX

Leg Colour



Colour Option

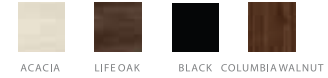

Top Shapes

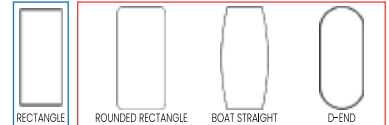

Technical Specifications

25mm THK melamine laminated chipboard in ASSORTED COLOUR. Steel leg in ASSORTED COLOUR.

RECTANGULAR VT LEG CONFERENCE TABLE * WITHOUT WIRE RISER

MODEL	DIMENSION (W*D*H)(mm)	PRICE
OF-VT-RC-3012	3000*1200*750	RM 2,078
OF-VT-RC-3612	3600*1200*750	RM 2,178
OF-VT-RC-4812	4800*1200*750	RM 2,288
OF-VT-RC-3015	3000*1500*750	RM 2,228
OF-VT-RC-3615	3600*1500*750	RM 2,388
OF-VT-RC-4815	4800*1500*750	RM 2,488

RECTANGULAR VT LEG CONFERENCE TABLE * WITH WIRE RISER

MODEL	DIMENSION (W*D*H)(mm)	PRICE
OF-VT-RC-WR-3012	3000*1200*750	RM 2,218
OF-VT-RC-WR-3612	3600*1200*750	RM 2,308
OF-VT-RC-WR-4812	4800*1200*750	RM 2,398
OF-VT-RC-WR-3015	3000*1500*750	RM 2,348
OF-VT-RC-WR-3615	3600*1500*750	RM 2,498
OF-VT-RC-WR-4815	4800*1500*750	RM 2,608

OVAL & BOAT VT LEG CONFERENCE TABLE * WITHOUT WIRE RISER

MODEL	DIMENSION (W*D*H)(mm)	PRICE
OF-VT-OC-3012 / OF-VT-BC-3012	3000*1200*750	RM 2,258
OF-VT-OC-3612 / OF-VT-BC-3612	3600*1200*750	RM 2,388
OF-VT-OC-4812 / OF-VT-BC-4812	4800*1200*750	RM 2,508
OF-VT-OC-3015 / OF-VT-BC-3015	3000*1500*750	RM 2,418
OF-VT-OC-3615 / OF-VT-BC-3615	3600*1500*750	RM 2,518
OF-VT-OC-4815 / OF-VT-BC-4815	4800*1500*750	RM 2,638

OVAL & BOAT VT LEG CONFERENCE TABLE * WITH WIRE RISER

MODEL	DIMENSION (W*D*H)(mm)	PRICE
OF-VT-OC-WR-3012 / OF-VT-BC-WR-3012	3000*1200*750	RM 2,398
OF-VT-OC-WR-3612 / OF-VT-BC-WR-3612	3600*1200*750	RM 2,508
OF-VT-OC-WR-4812 / OF-VT-BC-WR-4812	4800*1200*750	RM 2,628
OF-VT-OC-WR-3015 / OF-VT-BC-WR-3015	3000*1500*750	RM 2,538
OF-VT-OC-WR-3615 / OF-VT-BC-WR-3615	3600*1500*750	RM 2,638
OF-VT-OC-WR-4815 / OF-VT-BC-WR-4815	4800*1500*750	RM 2,748

RECTANGULAR VT LEG CONFERENCE TABLE

MODEL	DIMENSION (W*D*H)(mm)	PRICE
OF-VT-RC-1890	1800*900*750	RM 1,028
OF-VT-RC-2412	2400*1200*750	RM 1,288

OVAL & BOAT VT LEG CONFERENCE TABLE

MODEL	DIMENSION (W*D*H)(mm)	PRICE
OF-VT-OC-1890 / OF-VT-BC-1890	1800*900*750	RM 1,108
OF-VT-OC-2412 / OF-VT-BC-2412	2400*1200*750	RM 1,388



BOARDROOM TABLE SERIES

Leg Colour



Colour Option



PART	SHAPE	CODE	DIMENSION (W*D*H) mm	BASE (W*D*H) mm	PRICE	PART	SHAPE	CODE	DIMENSION (W*D*H) mm	BASE (W*D*H) mm	PRICE
ROUND TOP		OF-XC-R90	Ø900	590*590*725	RM 558	RECTANGULAR TOP c/w RISER		OF-XC-RC-3012	3000*1200	890*890*725	RM 2,268
		OF-XC-R120	Ø1200	890*590*725	RM 718			OF-XC-RC-3612	3600*1200	1040*1040*725	RM 2,408
SQUARE TOP		OF-XC-S90	900*900	740*740*725	RM 558			OF-XC-RC-3615	3600*1500	1040*1040*725	RM 2,548
		OF-XC-S120	1200*1200	1040*1040*725	RM 718			OF-XC-RC-4812	4800*1200	1040*1040*725	RM 2,488
RECTANGULAR TOP		OF-XC-RC-1890	1800*900	590*740*725	RM 1,088			OF-XC-RC-4815	4800*1500	1040*1040*725	RM 2,628
		OF-XC-RC-2190	2100*900	590*740*725	RM 1,188	BOAT SHAPE TOP		OF-XC-BC-1890	1800*900/750	590*590*725	RM 1,188
		OF-XC-RC-2490	2400*900	890*890*725	RM 1,468			OF-XC-BC-2190	2100*900/750	590*590*725	RM 1,428
		BOAT SHAPE TOP c/w RISER		OF-XC-BC-1890	1800*900/750	590*590*725	RM 1,188	OF-XC-BC-2412	2400*1200/900	890*890*725	RM 1,558
OF-XC-BC-2190	2100*900/750			590*590*725	RM 1,428	OF-XC-BC-3012	3000*1200/900	890*890*725	RM 2,468		
BOAT SHAPE TOP c/w RISER		OF-XC-BC-3012	3000*1200/900	890*890*725	RM 2,468	OF-XC-BC-3615	3600*1500/1200	1040*1040*725	RM 2,698		
		OF-XC-BC-3615	3600*1500/1200	1040*1040*725	RM 2,698	OF-XC-BC-4815	4800*1500/1200	1040*1040*725	RM 2,788		



X CROSS

WITHOUT SOCKET BOX



ANSON (WHITE ONLY)

BOAT SHAPE

CODE	DIMENSION (W*D*H) MM	DIY BOX	PRICE
OF-AN-BB18	1800*900/750*750	1	RM 948
OF-AN-BB24	2400*1200/900*750	1	RM 1,298
OF-AN-BB30	3000*1200/900*750	2	RM 1,758
OF-AN-BB36	3600*1500/1200*750	2	RM 2,098
OF-AN-BB48	4800*1500/1200*750	2	RM 2,638

RECTANGULAR SHAPE

CODE	DIMENSION (W*D*H) MM	DIY BOX	PRICE
OF-AN-VB18	1800*900*750	1	RM 958
OF-AN-VB24	2400*1200*750	1	RM 1,328
OF-AN-VB30	3000*1200*750	2	RM 1,808
OF-AN-VB36	3600*1500*750	2	RM 2,138
OF-AN-VB48	4800*1500*750	2	RM 2,678



BOARDROOM TABLE SERIES



LETO (WHITE ONLY)

BOAT SHAPE

CODE	DIMENSION (W*D*H) MM	DIY BOX	PRICE
OF-LT-BB18	1800*900/750*750	1	RM 948
OF-LT-BB24	2400*1200/900*750	1	RM 1,308
OF-LT-BB30	3000*1200/900*750	2	RM 1,938
OF-LT-BB36	3600*1500/1200*750	2	RM 2,288
OF-LT-BB48	4800*1500/1200*750	2	RM 3,008

RECTANGULAR SHAPE

CODE	DIMENSION (W*D*H) MM	DIY BOX	PRICE
OF-LT-VB18	1800*900*750	1	RM 958
OF-LT-VB24	2400*1200*750	1	RM 1,338
OF-LT-VB30	3000*1200*750	2	RM 1,988
OF-LT-VB36	3600*1500*750	2	RM 2,328
OF-LT-VB48	4800*1500*750	2	RM 3,058



ORLANDO

TOP: ACACIA WALNUT DARK GREY

TOP: 41 THK (mm) RECTANGULAR SHAPE

CODE	DIMENSION (W*D*H) MM	DIY BOX	PRICE
OF-ORLANDO-3015	3000*1500*766	3	RM 2,488
OF-ORLANDO-4515	4500*1500*766	4	RM 3,588
OF-ORLANDO-6015	6000*1500*766	5	RM 4,688



KARL

- RECTANGULAR
- OVAL
- BOAT SHAPE

Colour Option



CODE	DIMENSION (W*D*H)	DIY BOX	PRICE
OF-KARL-1800	1800*900*750	1	RM 1,628
OF-KARL-2400	2400*1200*750	1	RM 1,998
OF-KARL-3000	3000*1200*750	2	RM 2,928
OF-KARL-3600	3600*1500*750	2	RM 3,588
OF-KARL-4800	4800*1500*750	2	RM 4,188



BOARDROOM TABLE SERIES

S L55

TOP: BORAS ASH

BOAT SHAPE

CODE	DIMENSION (W*D*H)	DIY BOX	PRICE
SBB 18	1800*900/750*750	1	RM 999
SBB 24	2400*1200/900*750	1	RM 1,368
SBB 30	3000*1200/900*750	2	RM 1,899
SBB 36	3600*1500/1200*750	2	RM 2,268
SBB 48	4800*1500/1200*750	2	RM 2,898

RECTANGULAR SHAPE

CODE	DIMENSION (W*D*H)	DIY BOX	PRICE
SVB 18	1800*900*750	1	RM 999
SVB 24	2400*1200*750	1	RM 1,368
SVB 30	3000*1200*750	2	RM 1,899
SVB 36	3600*1500*750	2	RM 2,268
SVB 48	4800*1500*750	2	RM 2,898



T 22

TOP: MAPLE

RECTANGULAR SHAPE

CODE	DIMENSION (W*D*H)	DIY BOX	PRICE
TVE 18	1800*900*750	NIL	RM 538
TVE 24	2400*1200*750	NIL	RM 728

OVAL SHAPE

CODE	DIMENSION (W*D*H)	DIY BOX	PRICE
TOE 18	1800*900*750	NIL	RM 538
TOE 24	2400*1200*750	NIL	RM 728
TIB 36	3600*1200*750	2	RM 1,668

BOAT SHAPE

CODE	DIMENSION (W*D*H)	DIY BOX	PRICE
TBB 30	3000*1200/900*750	2	RM 1,668



V E R D A S E R I E S

HAMPSHIRE
WALNUT
LACQUER



Technical Specification

TOP SURFACE : 25mm thk melamine laminated chipboard in HAMPSHIRE colour
TABLE LEG : Wooden Leg in WALNUT LACQUER
MODESTY : Wooden
EDGING : 2mm thk PVC in HAMPSHIRE colour for top surface

Colour Option

Top Colour :  HAMPSHIRE

Leg :  WALNUT LACQUER



RECTANGULAR TABLE

OF-VD-MT4 W1200*D750*H750 MM **RM 998**
OF-VD-MT5 W1500*D750*H750 MM **RM 1,088**
OF-VD-MT6 W1800*D750*H750 MM **RM 1,208**

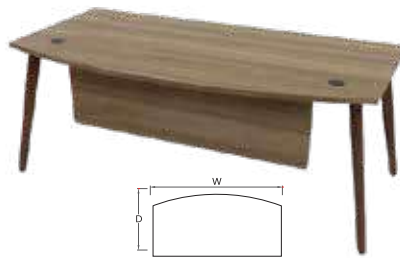

CURVE MAIN TABLE

OF-VD-MTC W1800*D900*H750 MM **RM 1,298**

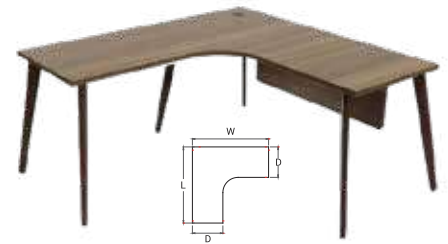

L-SHAPE TABLE

OF-VD-L1515 **RM 1,518**
W1500*D600*L1500*D600*H750 MM
OF-VD-L1818 **RM 1,598**
W1800*D600*L1800*D600*H750 MM



SIDE TABLE

OF-VD-ST **RM 828**
W1000*D600*H750 MM

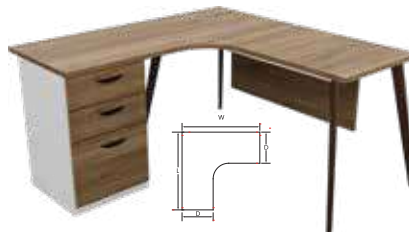

* c/w FIXED PEDESTAL

EXECUTIVE
L-SHAPE TABLE

OF-VD-LS15FP **RM 1,468**
W1500*D600*L1500*D600*H750 MM
*Fixed Pedestal : W396*D463*H725 MM
OF-VD-LS18FP **RM 1,578**
W1800*D600*L1800*D600*H750 MM
*Fixed Pedestal : W396*D463*H725 MM

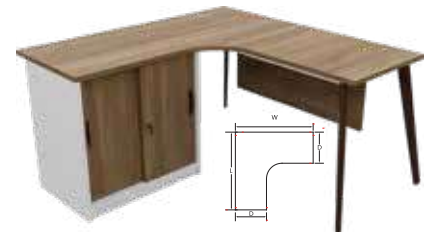

* c/w SLIDING DOOR CABINET

EXECUTIVE
L-SHAPE TABLE

OF-VD-LS15FC **RM 1,588**
W1500*D600*L1500*D600*H750 MM
*Fixed Sliding Door Cabinet : W746*D390*H725 MM
OF-VD-LS18FC **RM 1,688**
W1800*D600*L1800*D600*H750 MM
*Fixed Sliding Door Cabinet : W896*D390*H725 MM

CLUSTER WORKSTATION SERIES



VERDA

Colour Option **HAMPSHIRE**

Leg Colour Option **WALNUT**

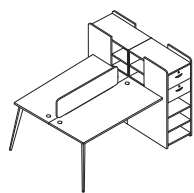

WORKSTATION CLUSTER OF 2
C/W FILING CABINET & WOODEN
HANGING DIVIDER PANEL

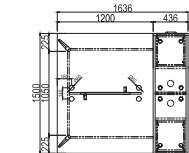

L1636*W1500*H1200/750 mm

RM 2,518

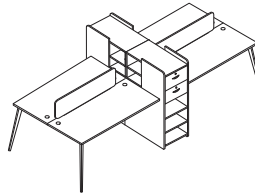

WORKSTATION CLUSTER OF 4
C/W FILING CABINET & WOODEN
HANGING DIVIDER PANEL

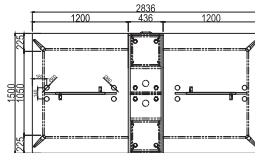

L2836*W1500*H1200/750 mm

RM 3,688

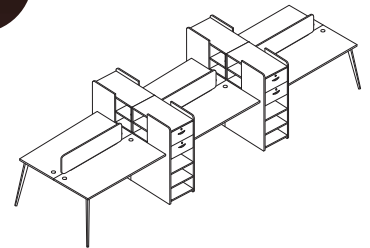

WORKSTATION CLUSTER OF 6
C/W FILING CABINET & WOODEN
HANGING DIVIDER PANEL

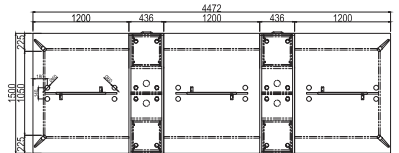

L4472*W1500*H1200/750 mm

RM 5,928

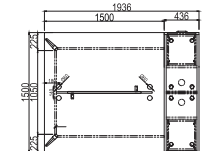

L1936*W1500*H1200/750 mm

RM 2,798

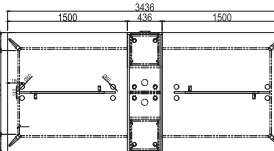

L3436*W1500*H1200/750 mm

RM 4,228

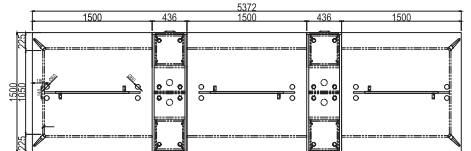

L5372*W1500*H1200/750 mm

RM 6,648

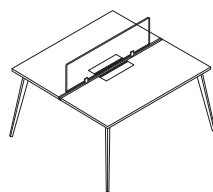
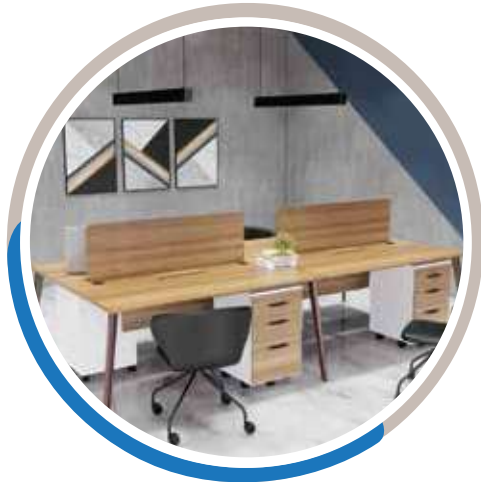

VERDA WORKSTATION
CLUSTER OF 2

L1200*W1500*H750 mm **RM 1,888**
L1500*W1500*H750 mm **RM 1,998**
L1800*W1500*H750 mm **RM 2,268**

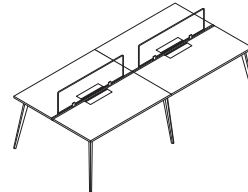

VERDA WORKSTATION
CLUSTER OF 4

L2400*W1500*H750 mm **RM 3,388**
L3000*W1500*H750 mm **RM 3,688**
L3600*W1500*H750 mm **RM 4,188**

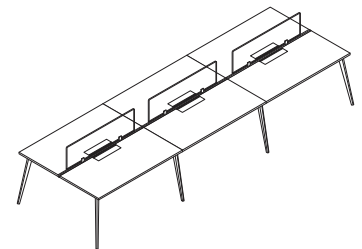

VERDA WORKSTATION
CLUSTER OF 6

L3600*W1500*H750 mm **RM 4,888**
L4500*W1500*H750 mm **RM 5,388**
L5400*W1500*H750 mm **RM 6,108**

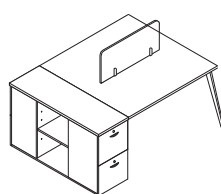

WORKSTATION SET -
CLUSTER OF 2 C/W
FIXED PEDESTAL 2D2F

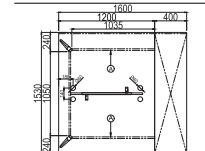

L1600*W1530*H1095/750 mm

RM 2,268

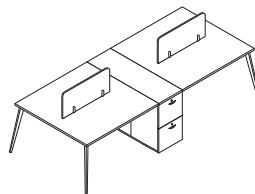

WORKSTATION SET -
CLUSTER OF 4 C/W
FIXED PEDESTAL 2D2F

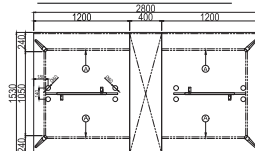

L2800*W1530*H1095/750 mm

RM 3,408

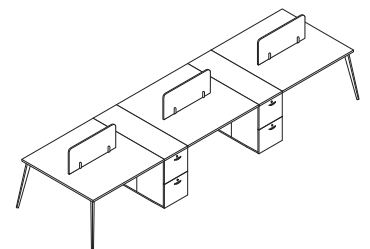

WORKSTATION SET -
CLUSTER OF 6 C/W
FIXED PEDESTAL 2D2F

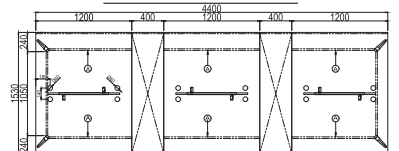

L4400*W1530*H1095/750 mm

RM 5,388

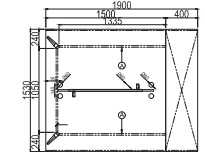

L1900*W1530*H1095/750 mm

RM 2,588

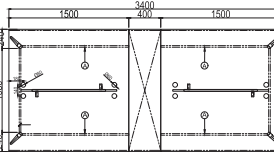

L3400*W1530*H1095/750 mm

RM 4,028

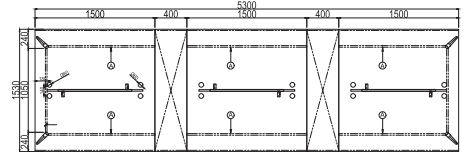

L5300*W1530*H1095/750 mm

RM 6,288



MOBILE PEDESTAL 1D1F
OF-VD-MP1D1F
W400*D470*H560 mm
RM 305



MOBILE PEDESTAL 3D
OF-VD-MP3D
W400*D470*H525 mm
RM 275



MOBILE PEDESTAL 2D1F
OF-VD-MP2D+1F
W400*D470*H660 mm
RM 358



MOBILE PEDESTAL 4D
OF-VD-MP-4D
W400*D450*H660 mm
RM 318



FIXED PEDESTAL 2D1F
OF-VD-FP-2D1F
W396*D446*H725 mm
RM 358



LOW OPEN SHELF CABINET
OF-VD-OSC802
W800*D410*H836 mm
RM 268



MEDIUM OPEN SHELF CABINET
OF-VD-OSC803
W800*D410*H1236 mm
RM 338



HIGH OPEN SHELF CABINET
OF-VD-OSC804
W800*D410*H1672 mm
RM 448



HIGH OPEN SHELF CABINET
OF-VD-OSC805
W800*D410*H2072 mm
RM 558



LOW SWING DOOR CABINET
OF-VD-SWC802
W800*D410*H836 mm
RM 378



MEDIUM SWING DOOR CABINET
OF-VD-SWC803
W800*D410*H1236 mm
RM 488



HIGH SWING DOOR CABINET
OF-VD-SWC804
W800*D410*H1672 mm
RM 658



HIGH SWING DOOR CABINET
OF-VD-SWC805
W800*D410*H2072 mm
RM 808



LOW SWING GLASS DOOR CABINET
OF-VD-SGC802
W800*D410*H836 mm
RM 598



MEDIUM SWING GLASS DOOR CABINET
OF-VD-SGC803
W800*D410*H1236 mm
RM 788



LOW SLIDING DOOR CABINET
OF-VD-SL-802
W800*D410*H836 mm
RM 388



MEDIUM SLIDING DOOR CABINET
OF-VD-SL-803
W800*D410*H1236 mm
RM 498



FIXED SLIDING DOOR CABINET
OF-VD-FSLC-75
W750*D410*H725 mm
RM 358



PLANTER BOX C/W 4 DOOR & PVC BOXES
OF-VD-SWPB-8011
W800*D400*H1100 mm
RM 708



LOW SINGLE SWING DOOR CABINET
OF-VD-SSD-402
W400*D410*H836 mm
RM 268



MEDIUM SINGLE SWING DOOR CABINET
OF-VD-SSD-403
W400*D410*H1236 mm
RM 368



HIGH SINGLE SWING DOOR CABINET
OF-VD-SSD-404
W400*D410*H1672 mm
RM 468



LOW SINGLE SWING GLASS DOOR CABINET
OF-VD-SSGD-402
W400*D410*H836 mm
RM 388



MEDIUM SINGLE SWING GLASS DOOR CABINET
OF-VD-SSGD-403
W400*D410*H1236 mm
RM 528

Colour Option

Top & Body



WHITE



DARK GREY

FRONT DRAWER & DOOR



HAMPSHIRE



TEAK



MAPLE



WHITE



DARK GREY

MAVEN

SERIES

FAGGIONA
BLACK



Technical Specification

TOP SURFACE : 25mm thk melamine chipboard in FAGGIONA colour
TABLE LEG : Angular metal leg in EPOXY BLACK colour
MODESTY : 18mm thk melamine laminated chipboard in BLACK colour
EDGING : 2mm thk PVC in FAGGIONA colour for top surface

Colour Option

Top Colour : WARM ROVERE CELTIC ASH ACACIA Leg : BLACK
 FAGGIONA LIFE OAK



* w/o MODESTY PANEL

STRAIGHT MAIN TABLE

- OF-MB-MT4(O)** W1200*D750*H750 MM **RM 828**
- OF-MB-MT5(O)** W1500*D750*H750 MM **RM 958**
- OF-MB-MT6(O)** W1800*D750*H750 MM **RM 998**



* c/w MODESTY PANEL

STRAIGHT MAIN TABLE

- OF-MB-MT4** W1200*D750*H750 MM **RM 938**
- OF-MB-MT5** W1500*D750*H750 MM **RM 1,068**
- OF-MB-MT6** W1800*D750*H750 MM **RM 1,128**

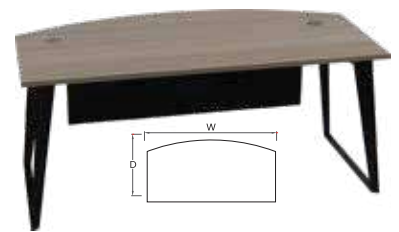

CURVE MAIN TABLE

- OF-MB-MTC** **RM 1,178**
W1800*D900*H750 MM

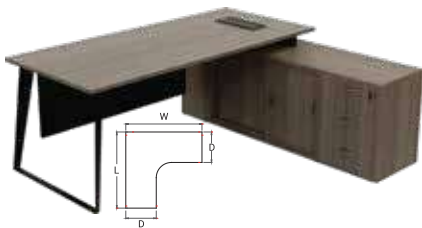

DIRECTOR SET

- MAVEN DIRECTOR SET** **RM 2,588**
W2100*D900*L1800*D450*H750 MM
*(c/w DLY box)

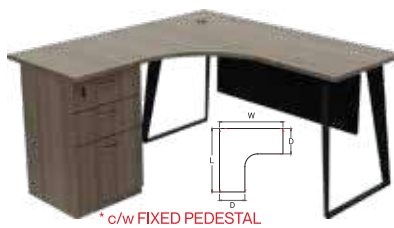

EXECUTIVE L-SHAPE TABLE

- OF-MB-LS15FP** **RM 1,428**
W1500*D750*L1500*D600*H750 MM
- OF-MB-LS18FP** **RM 1,488**
W1800*D750*L1800*D600*H750 MM



EXECUTIVE L-SHAPE TABLE

- OF-MB-LS15FC** **RM 1,488**
W1500*D750*L1500*D600*H750 MM
*Fixed Sliding Door Cabinet : W746*D390*H725 MM
- OF-MB-LS18FC** **RM 1,588**
W1800*D750*L1800*D600*H750 MM
*Fixed Sliding Door Cabinet : W896*D390*H725 MM

CLUSTER WORKSTATION SERIES



MAVEN SERIES (exclude wooden panel & socket box)

Technical Specification

Top Surface : 25mm thk melamine laminated chipboard in **ASSORTED COLOUR**

Table Leg : Steel leg in **BLACK** colour.

Colour Option



Leg Colour Option



4 PAX FACE TO FACE

6 PAX FACE TO FACE



*WITHOUT WIRE RISER

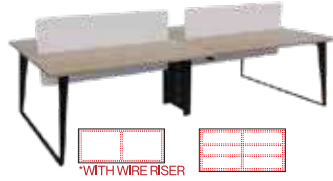

*WITH WIRE RISER

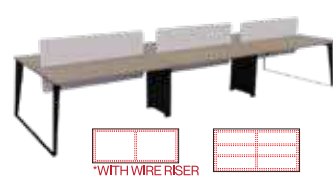

*WITH WIRE RISER

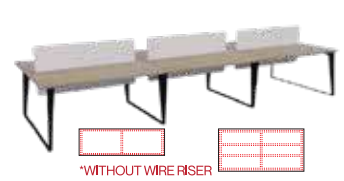

*WITHOUT WIRE RISER

C4-D3012-MBBK
W3000*D1200*H750 mm
RM 2,438



C4-D3012WR-MBBK
W3000*D1200*H750 mm
RM 2,168



C6-D4512WR-MBBK
W4500*D1200*H750 mm
RM 3,088

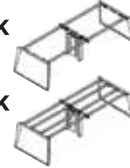

C6-D4512-MBBK
W4500*D1200*H750 mm
RM 3,488



C4-D3015-MBBK
W3000*D1500*H750 mm
RM 3,128

C4-D3015WR-MBBK
W3000*D1500*H750 mm
RM 2,988

C6-D4515WR-MBBK
W4500*D1500*H750 mm
RM 4,288

C6-D4515-MBBK
W4500*D1500*H750 mm
RM 4,488



BEACON SERIES (exclude wooden panel & socket box)

Technical Specification

Top Surface : 25mm thk melamine laminated chipboard in **ASSORTED COLOUR**

Table Leg : Steel leg in **COFFEE** colour.

Colour Option



Leg Colour Option



4 PAX FACE TO FACE

6 PAX FACE TO FACE

4 PAX FACE TO FACE

6 PAX FACE TO FACE



C4-D3012WR-BCCOF
W3000*D1200*H750 mm
RM 2,482



C6-D4512WR-BCCOF
W4500*D1200*H750 mm
RM 3,532



C4-D3015WR-BCCOF
W3000*D1500*H750 mm
RM 2,822



C6-D4515WR-BCCOF
W4500*D1500*H750 mm
RM 4,022

*Images provided are for illustration purposes only. *Prices quoted are subject to change without prior notice & while stocks last. *Terms & conditions apply. *While every care is taken in the preparation of this flyer any inaccuracy or omission is much regretted.

MITRA SERIES

PEGASUS



Technical Specification

TOP SURFACE : 25mm thk melamine chipboard in PEGASUS colour
TABLE LEG : 50mm x 50mm metal leg + aluminium connector + metal beam
MODESTY : Steel
EDGING : 2mm thk PVC in PEGASUS colour for top surface

Colour Option

Top Colour : OAK PEGASUS CELTIC ASH TEAK HAMPSHIRE

Beam : BLACK WHITE

Leg : WHITE BLACK

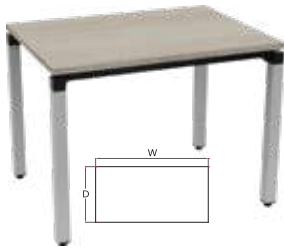

SIDE TABLE

OF-MI-ST W1000*D600*H750 MM

RM 658

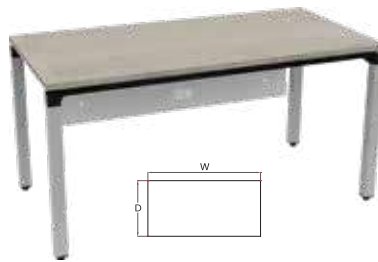

STRAIGHT MAIN TABLE

OF-MI-MT4 W1200*D750*H750 MM

RM 758

OF-MI-MT5 W1500*D750*H750 MM

RM 888

OF-MI-MT6 W1800*D750*H750 MM

RM 958

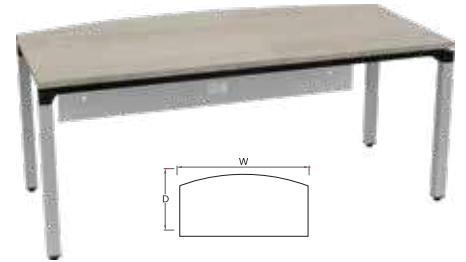

CURVE MAIN TABLE

OF-MI-MTC W1800*D900*H750 MM

RM 998

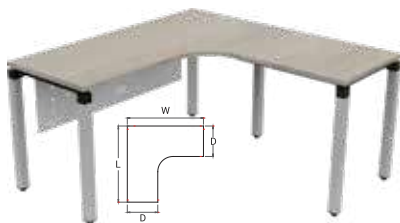

L-SHAPE TABLE

OF-MI-LS15 **RM 1,238**

W1500*D600*L1500*D600*H750 MM

OF-MI-LS18 **RM 1,348**

W1800*D600*L1800*D600*H750 MM

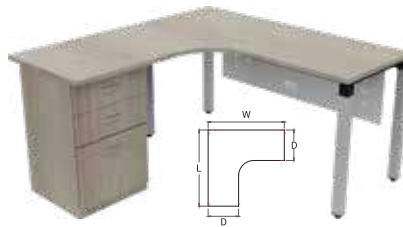

*c/w FIXED PEDESTAL

EXECUTIVE L-SHAPE TABLE

OF-MI-LS15FP **RM 1,248**

W1500*D600*L1500*D600*H750 MM

OF-MI-LS18FP **RM 1,328**

W1800*D600*L1800*D600*H750 MM

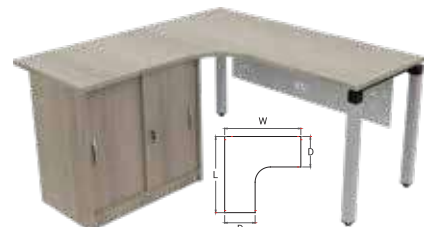

*c/w FIXED SLIDING DOOR CABINET

EXECUTIVE L-SHAPE TABLE

OF-MI-LS15FC **RM 1,298**

W1500*D600*L1500*D600*H750 MM

*Fixed Sliding Door Cabinet: W746*D390*H725 MM

OF-MI-LS18FC **RM 1,438**

W1800*D600*L1800*D600*H750 MM

*Fixed Sliding Door Cabinet: W896*D390*H725 MM

PEGASUS
GREY

CLUSTER WORKSTATION SERIES



OF-MI-VR-2
W3016 * D1516 * H750 MM
RM 2,998



OF-MI-VR-3
W2696 * D2336 * H750 MM
RM 3,198



OF-MI-VR-4
W3016 * D3016 * H750 MM
RM 3,788



Technical Specification

Top Surface : 25mm thk melamine laminated chipboard in **ASSORTED COLOUR**

Table Leg : 50mm x 50mm Metal leg + Aluminium connector + metal BEAM

Colour Option



Leg Colour Option

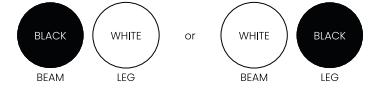

WITHOUT WIRE RISER (exclude wooden panel & socket box)

MI LEG CONCEPT - 2 PAX SIDE BY SIDE

MODEL	SIZE (W*D*H) (mm)	PRICE
C2-D2460-MIWH	2400*600*750	RM 1,308
C2-D3060-MIWH	3000*600*750	RM 1,468
C2-D3660-MIWH	3600*600*750	RM 1,588
C2-D2475-MIWH	2400*750*750	RM 1,368
C2-D3075-MIWH	3000*750*750	RM 1,638
C2-D3675-MIWH	3600*750*750	RM 1,758

MI LEG CONCEPT - 4 PAX SIDE BY SIDE

MODEL	SIZE (W*D*H) (mm)	PRICE
C4-D4860-MIWH	4800*600*750	RM 2,188
C4-D6060-MIWH	6000*600*750	RM 2,688
C4-D7260-MIWH	7200*600*750	RM 2,888
C4-D4875-MIWH	4800*750*750	RM 2,458
C4-D6075-MIWH	6000*750*750	RM 2,988
C4-D7275-MIWH	7200*750*750	RM 3,228

MI LEG CONCEPT - 3 PAX SIDE BY SIDE

MODEL	SIZE (W*D*H) (mm)	PRICE
C3-D3660-MIWH	3600*600*750	RM 1,788
C3-D4560-MIWH	4500*600*750	RM 2,088
C3-D5460-MIWH	5400*600*750	RM 2,248
C3-D3675-MIWH	3600*750*750	RM 1,898
C3-D4575-MIWH	4500*750*750	RM 2,298
C3-D5475-MIWH	5400*750*750	RM 2,488

MI LEG CONCEPT - 2 PAX FACE TO FACE

MODEL	SIZE (W*D*H) (mm)	PRICE
C2-D1212-MIWH	1200*1200*750	RM 898
C2-D1512-MIWH	1500*1200*750	RM 1,058
C2-D1812-MIWH	1800*1200*750	RM 1,138
C2-D1215-MIWH	1200*1500*750	RM 1,028
C2-D1515-MIWH	1500*1500*750	RM 1,248
C2-D1815-MIWH	1800*1500*750	RM 1,338

WITHOUT WIRE RISER (exclude wooden panel & socket box)

MI LEG CONCEPT - 4 PAX FACE TO FACE

MODEL	SIZE (W*D*H) (mm)	PRICE
C4-D2412-MIWH	2400*1200*750	RM 1,538
C4-D3012-MIWH	3000*1200*750	RM 1,858
C4-D3612-MIWH	3600*1200*750	RM 2,028
C4-D2415-MIWH	2400*1500*750	RM 1,788
C4-D3015-MIWH	3000*1500*750	RM 2,228
C4-D3615-MIWH	3600*1500*750	RM 2,398

MI LEG CONCEPT - 6 PAX FACE TO FACE

MODEL	SIZE (W*D*H) (mm)	PRICE
C6-D3612-MIWH	3600*1200*750	RM 2,188
C6-D4512-MIWH	4500*1200*750	RM 2,668
C6-D5412-MIWH	5400*1200*750	RM 2,898
C6-D3615-MIWH	3600*1500*750	RM 2,518
C6-D4515-MIWH	4500*1500*750	RM 3,198
C6-D5415-MIWH	5400*1500*750	RM 3,398

MI LEG CONCEPT - 8 PAX FACE TO FACE

MODEL	SIZE (W*D*H) (mm)	PRICE
C8-D4812-MIWH	4800*1200*750	RM 2,828
C8-D6012-MIWH	6000*1200*750	RM 3,458
C8-D7212-MIWH	7200*1200*750	RM 3,768
C8-D4815-MIWH	4800*1500*750	RM 3,268
C8-D6015-MIWH	6000*1500*750	RM 4,148
C8-D7215-MIWH	7200*1500*750	RM 4,438

WITH WIRE RISER (exclude wooden panel & socket box)

MODEL	SIZE (W*D*H) (mm)	PRICE
C4-D2412WR-MIWH	2400*1200*750	RM 1,848
C4-D3012WR-MIWH	3000*1200*750	RM 2,188
C4-D3612WR-MIWH	3600*1200*750	RM 2,338
C4-D2415WR-MIWH	2400*1500*750	RM 1,938
C4-D3015WR-MIWH	3000*1500*750	RM 2,388
C4-D3615WR-MIWH	3600*1500*750	RM 2,568

MODEL	SIZE (W*D*H) (mm)	PRICE
C6-D3612WR-MIWH	3600*1200*750	RM 2,468
C6-D4512WR-MIWH	4500*1200*750	RM 2,948
C6-D5412WR-MIWH	5400*1200*750	RM 3,188
C6-D3615WR-MIWH	3600*1500*750	RM 2,778
C6-D4515WR-MIWH	4500*1500*750	RM 3,448
C6-D5415WR-MIWH	5400*1500*750	RM 3,698

MODEL	SIZE (W*D*H) (mm)	PRICE
C8-D4812WR-MIWH	4800*1200*750	RM 3,248
C8-D6012WR-MIWH	6000*1200*750	RM 3,898
C8-D7212WR-MIWH	7200*1200*750	RM 4,198
C8-D4815WR-MIWH	4800*1500*750	RM 3,638
C8-D6015WR-MIWH	6000*1500*750	RM 4,538
C8-D7215WR-MIWH	7200*1500*750	RM 4,898

NB OL VA VC AK SERIES

WHITE
OAK
BLACK



Technical Specification

TOP SURFACE : 26mm thk melamine chipboard in WHITE OAK colour
TABLE LEG : 50mm x 50mm metal leg in BLACK colour
MODESTY : Steel
EDGING : 2mm thk PVC in WHITE OAK colour for top surface

Colour Option

Top Colour : WHITE OAK BLACK COMFY LATTE (Matt Surface) ACACIA LIFE OAK SHIMO ASH CELTIC ASH

Leg : BLACK SILVER DARK GREY



SIDE TABLE

OF-NV-ST

W1000*D600*H750 MM

RM 448



STRAIGHT MAIN TABLE

OF-NV-MT4 W1200*D750*H750 MM

RM 558

OF-NV-MT5 W1500*D750*H750 MM

RM 678

OF-NV-MT6 W1800*D750*H750 MM

RM 728



CURVE MAIN TABLE

OF-NV-MTC

W1800*D900*H750 MM

RM 778

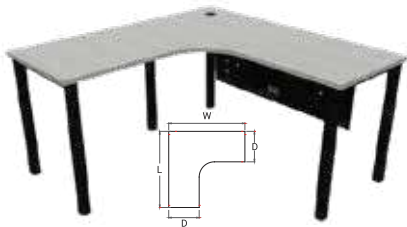

L-SHAPE TABLE

OF-NV-LS15

W1500*D600*L1500*D600*H750 MM

RM 888

OF-NV-LS18

W1800*D600*L1800*D600*H750 MM

RM 948

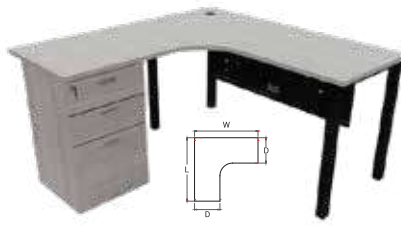

* c/w FIXED PEDESTAL

EXECUTIVE
L-SHAPE TABLE

OF-NV-LS15FP

W1500*D600*L1500*D600*H750 MM

RM 1,038

OF-NV-LS18FP

W1800*D600*L1800*D600*H750 MM

RM 1,098

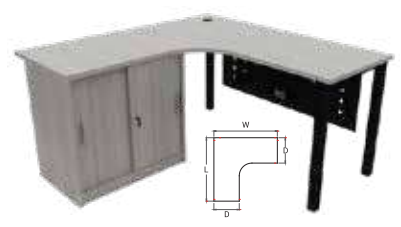

*c/w SLIDING DOOR CABINET

EXECUTIVE
L-SHAPE TABLE

OF-NV-LS15FC

W1500*D600*L1500*D600*H750 MM

RM 1,098

*Fixed Sliding Door Cabinet : W746*D390*H725 MM

OF-NV-LS18FC

W1800*D600*L1800*D600*H750 MM

RM 1,198

*Fixed Sliding Door Cabinet : W896*D390*H725 MM



CLUSTER WORKSTATION SERIES



Technical Specification

Top Surface : 25mm thk melamine laminated chipboard in **ASSORTED COLOUR**

Table Leg : 50mm x 50mm metal leg in **ASSORTED COLOUR**

Colour Option



Leg Colour Option



WITHOUT WIRE RISER (exclude wooden panel & socket box)

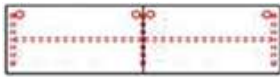

NV LEG CONCEPT - 2 PAX SIDE BY SIDE

MODEL	SIZE (W*D*H) (mm)	PRICE
C2-D2460-NVWH	2400*600*750	RM 808
C2-D3060-NVWH	3000*600*750	RM 958
C2-D3660-NVWH	3600*600*750	RM 1,028
C2-D2475-NVWH	2400*750*750	RM 928
C2-D3075-NVWH	3000*750*750	RM 1,138
C2-D3675-NVWH	3600*750*750	RM 1,218

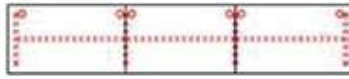

NV LEG CONCEPT - 3 PAX SIDE BY SIDE

MODEL	SIZE (W*D*H) (mm)	PRICE
C3-D3660-NVWH	3600*600*750	RM 1,148
C3-D4560-NVWH	4500*600*750	RM 1,368
C3-D5460-NVWH	5400*600*750	RM 1,468
C3-D3675-NVWH	3600*750*750	RM 1,328
C3-D4575-NVWH	4500*750*750	RM 1,648
C3-D5475-NVWH	5400*750*750	RM 1,768

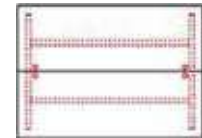

NV LEG CONCEPT - 2 PAX FACE TO FACE

MODEL	SIZE (W*D*H) (mm)	PRICE
C2-D1212-NVWH	1200*1200*750	RM 758
C2-D1512-NVWH	1500*1200*750	RM 908
C2-D1812-NVWH	1800*1200*750	RM 968
C2-D1215-NVWH	1200*1500*750	RM 868
C2-D1515-NVWH	1500*1500*750	RM 1,078
C2-D1815-NVWH	1800*1500*750	RM 1,158

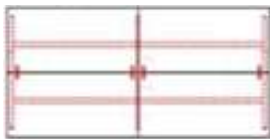

NV LEG CONCEPT - 4 PAX FACE TO FACE

MODEL	SIZE (W*D*H) (mm)	PRICE
C4-D2412-NVWH	2400*1200*750	RM 1,348
C4-D3012-NVWH	3000*1200*750	RM 1,648
C4-D3612-NVWH	3600*1200*750	RM 1,778
C4-D2415-NVWH	2400*1500*750	RM 1,568
C4-D3015-NVWH	3000*1500*750	RM 1,988
C4-D3615-NVWH	3600*1500*750	RM 2,148

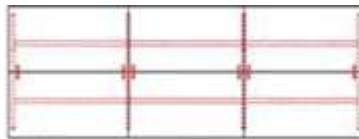

NV LEG CONCEPT - 6 PAX FACE TO FACE

MODEL	SIZE (W*D*H) (mm)	PRICE
C6-D3612-NVWH	3600*1200*750	RM 1,948
C6-D4512-NVWH	4500*1200*750	RM 2,388
C6-D5412-NVWH	5400*1200*750	RM 2,588
C6-D3615-NVWH	3600*1500*750	RM 2,258
C6-D4515-NVWH	4500*1500*750	RM 2,898
C6-D5415-NVWH	5400*1500*750	RM 3,138

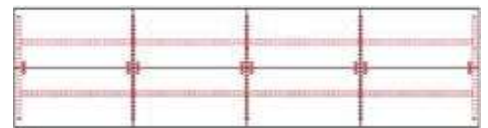

NV LEG CONCEPT - 8 PAX FACE TO FACE

MODEL	SIZE (W*D*H) (mm)	PRICE
C8-D4812-NVWH	4800*1200*750	RM 2,528
C8-D6012-NVWH	6000*1200*750	RM 3,128
C8-D7212-NVWH	7200*1200*750	RM 3,388
C8-D4815-NVWH	4800*1500*750	RM 2,958
C8-D6015-NVWH	6000*1500*750	RM 3,798
C8-D7215-NVWH	7200*1500*750	RM 4,118

WITH WIRE RISER (exclude wooden panel & socket box)

MODEL	SIZE (W*D*H) (mm)	PRICE
C4-D2412WR-NVWH	2400*1200*750	RM 1,468
C4-D3012WR-NVWH	3000*1200*750	RM 1,768
C4-D3612WR-NVWH	3600*1200*750	RM 1,908
C4-D2415WR-NVWH	2400*1500*750	RM 1,698
C4-D3015WR-NVWH	3000*1500*750	RM 2,118
C4-D3615WR-NVWH	3600*1500*750	RM 2,278

MODEL	SIZE (W*D*H) (mm)	PRICE
C6-D3612WR-NVWH	3600*1200*750	RM 2,188
C6-D4512WR-NVWH	4500*1200*750	RM 2,638
C6-D5412WR-NVWH	5400*1200*750	RM 2,838
C6-D3615WR-NVWH	3600*1500*750	RM 2,528
C6-D4515WR-NVWH	4500*1500*750	RM 3,158
C6-D5415WR-NVWH	5400*1500*750	RM 3,398

MODEL	SIZE (W*D*H) (mm)	PRICE
C8-D4812WR-NVWH	4800*1200*750	RM 2,908
C8-D6012WR-NVWH	6000*1200*750	RM 3,508
C8-D7212WR-NVWH	7200*1200*750	RM 3,778
C8-D4815WR-NVWH	4800*1500*750	RM 3,348
C8-D6015WR-NVWH	6000*1500*750	RM 4,188
C8-D7215WR-NVWH	7200*1500*750	RM 4,508

*Images provided are for illustration purposes only. *Prices quoted are subject to change without prior notice & while stocks last. *Terms & conditions apply. *While every care is taken in the preparation of this flyer any inaccuracy or omission is much regretted.

LOOP

SERIES

TEAK



Technical Specification

TOP SURFACE : 25mm thk melamine chipboard in TEAK colour
TABLE LEG : 75mm x 25mm metal leg in EPOXY WHITE colour
MODESTY : Steel
EDGING : 2mm thk PVC in TEAK colour for top surface

Colour Option

Top Colour :  TEAK

Additional :
charges
apply

 HAZEL

 HAMPSHIRE

 ALON

Leg :  WHITE

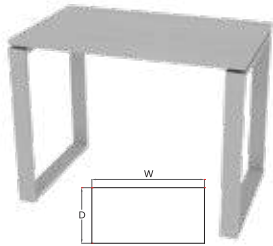

SIDE TABLE

OF-LP-ST

W1000*D600*H750 MM

RM 448



STRAIGHT MAIN TABLE

OF-LP-MT4

W1200*D750*H750 MM

RM 518

OF-LP-MT5

W1500*D750*H750 MM

RM 568

OF-LP-MT6

W1800*D750*H750 MM

RM 618

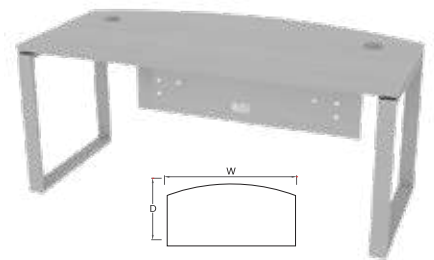

CURVE MAIN TABLE

OF-LP-MTC

W1800*D900*H750 MM

RM 768

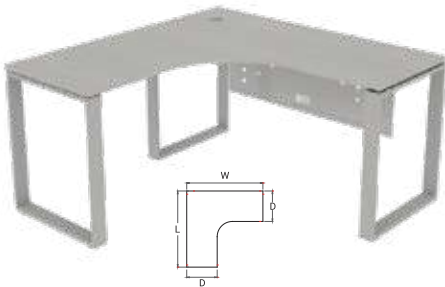

L-SHAPE TABLE

OF-LP-LS15

W1500*D600*L1500*D600*H750 MM

RM 768

OF-LP-LS18

W1800*D600*L1800*D600*H750 MM

RM 898

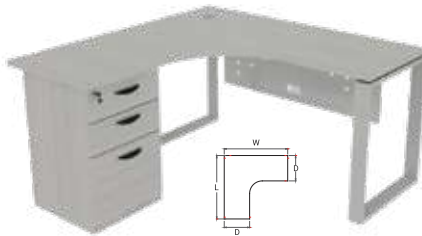

* c/w FIXED PEDESTAL

EXECUTIVE
L-SHAPE TABLE

OF-LP-LS15FP

W1500*D600*L1500*D600*H750 MM

RM 898

OF-LP-LS18FP

W1800*D600*L1800*D600*H750 MM

RM 978

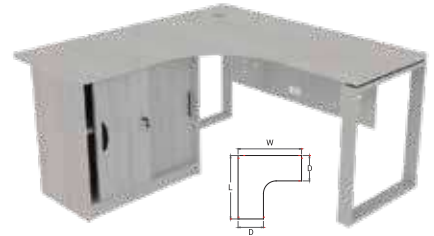

* c/w SLIDING DOOR CABINET

EXECUTIVE
L-SHAPE TABLE

OF-LP-LS15FC

W1500*D600*L1500*D600*H750 MM

RM 1,038

*Fixed Sliding Door Cabinet : W746*D390*H725 MM

OF-LP-LS18FC

W1800*D600*L1800*D600*H750 MM

RM 1,138

*Fixed Sliding Door Cabinet : W896*D390*H725 MM



CLUSTER WORKSTATION SERIES

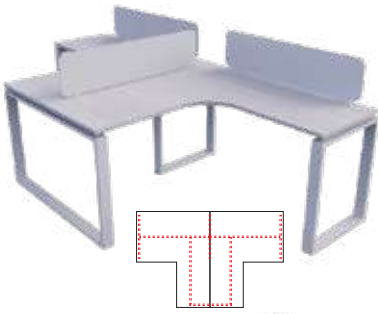

OF-LP-VR-2
W3016 * D1516 * H750 MM
RM 2,228

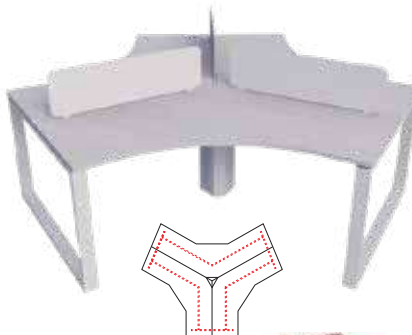

OF-LP-VR-3
W2696 * D2336 * H750 MM
RM 2,898



OF-LP-VR-4
W3016 * D3016 * H750 MM
RM 3,898



Technical Specification

Top Surface : 25mm thk melamine laminated chipboard in **ASSORTED COLOUR**

Table Leg : 75mm x 25mm metal leg in **ASSORTED COLOUR**



Colour Option



Leg Colour Option



WITHOUT WIRE RISER (exclude wooden panel & socket box)

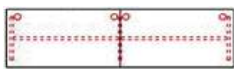

LP LEG CONCEPT - 2 PAX SIDE BY SIDE

MODEL	SIZE (W*D*H) (mm)	PRICE
C2-D2460-LPWH	2400*600*750	RM 868
C2-D3060-LPWH	3000*600*750	RM 1,018
C2-D3660-LPWH	3600*600*750	RM 1,088
C2-D2475-LPWH	2400*750*750	RM 1,008
C2-D3075-LPWH	3000*750*750	RM 1,218
C2-D3675-LPWH	3600*750*750	RM 1,298

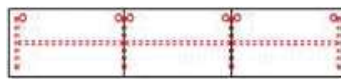

LP LEG CONCEPT - 3 PAX SIDE BY SIDE

MODEL	SIZE (W*D*H) (mm)	PRICE
C3-D3660-LPWH	3600*600*750	RM 1,228
C3-D4560-LPWH	4500*600*750	RM 1,448
C3-D5460-LPWH	5400*600*750	RM 1,548
C3-D3675-LPWH	3600*750*750	RM 1,428
C3-D4575-LPWH	4500*750*750	RM 1,748
C3-D5475-LPWH	5400*750*750	RM 1,868

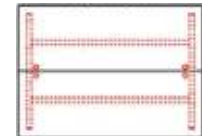

LP LEG CONCEPT - 2 PAX FACE TO FACE

MODEL	SIZE (W*D*H) (mm)	PRICE
C2-D1212-LPWH	1200*1200*750	RM 848
C2-D1512-LPWH	1500*1200*750	RM 998
C2-D1812-LPWH	1800*1200*750	RM 1,058
C2-D1215-LPWH	1200*1500*750	RM 998
C2-D1515-LPWH	1500*1500*750	RM 1,208
C2-D1815-LPWH	1800*1500*750	RM 1,288



LP LEG CONCEPT - 4 PAX FACE TO FACE

MODEL	SIZE (W*D*H) (mm)	PRICE
C4-D2412-LPWH	2400*1200*750	RM 1,468
C4-D3012-LPWH	3000*1200*750	RM 1,768
C4-D3612-LPWH	3600*1200*750	RM 1,908
C4-D2415-LPWH	2400*1500*750	RM 1,748
C4-D3015-LPWH	3000*1500*750	RM 2,168
C4-D3615-LPWH	3600*1500*750	RM 2,328



LP LEG CONCEPT - 6 PAX FACE TO FACE

MODEL	SIZE (W*D*H) (mm)	PRICE
C6-D3612-LPWH	3600*1200*750	RM 2,098
C6-D4512-LPWH	4500*1200*750	RM 2,548
C6-D5412-LPWH	5400*1200*750	RM 2,748
C6-D3615-LPWH	3600*1500*750	RM 2,498
C6-D4515-LPWH	4500*1500*750	RM 3,128
C6-D5415-LPWH	5400*1500*750	RM 3,368



LP LEG CONCEPT - 8 PAX FACE TO FACE

MODEL	SIZE (W*D*H) (mm)	PRICE
C8-D4812-LPWH	4800*1200*750	RM 2,728
C8-D6012-LPWH	6000*1200*750	RM 3,328
C8-D7212-LPWH	7200*1200*750	RM 3,598
C8-D4815-LPWH	4800*1500*750	RM 3,248
C8-D6015-LPWH	6000*1500*750	RM 4,088
C8-D7215-LPWH	7200*1500*750	RM 4,408

WITH WIRE RISER (exclude wooden panel & socket box)

MODEL	SIZE (W*D*H) (mm)	PRICE
C4-D2412WR-LPWH	2400*1200*750	RM 1,678
C4-D3012WR-LPWH	3000*1200*750	RM 1,978
C4-D3612WR-LPWH	3600*1200*750	RM 2,108
C4-D2415WR-LPWH	2400*1500*750	RM 1,958
C4-D3015WR-LPWH	3000*1500*750	RM 2,378
C4-D3615WR-LPWH	3600*1500*750	RM 2,538

MODEL	SIZE (W*D*H) (mm)	PRICE
C6-D3612WR-LPWH	3600*1200*750	RM 2,518
C6-D4512WR-LPWH	4500*1200*750	RM 2,948
C6-D5412WR-LPWH	5400*1200*750	RM 3,168
C6-D3615WR-LPWH	3600*1500*750	RM 2,918
C6-D4515WR-FZWH	4500*1500*750	RM 3,548
C6-D5415WR-LPWH	5400*1500*750	RM 3,788

MODEL	SIZE (W*D*H) (mm)	PRICE
C8-D4812WR-LPWH	4800*1200*750	RM 3,348
C8-D6012WR-LPWH	6000*1200*750	RM 3,948
C8-D7212WR-LPWH	7200*1200*750	RM 4,218
C8-D4815WR-LPWH	4800*1500*750	RM 3,868
C8-D6015WR-LPWH	6000*1500*750	RM 4,708
C8-D7215WR-LPWH	7200*1500*750	RM 5,028

M I L L A SERIES

PETUNA
BLACK



Technical Specification

TOP SURFACE : 25mm thk melamine chipboard in **PETUNA BLACK** colour
TABLE LEG : 50mm*50mm metal leg in **EPOXY WHITE** colour
MODESTY : Steel
EDGING : 2mm thk PVC in **PETUNA BLACK** colour for top surface

Colour Option

- Top Colour** :
- CAPPUCINO
 - ELMER
 - WALNUT
 - BEECH
 - THUJA LIGHT
 - PETUNA BLACK
- Leg** :
- WHITE
 - BLACK

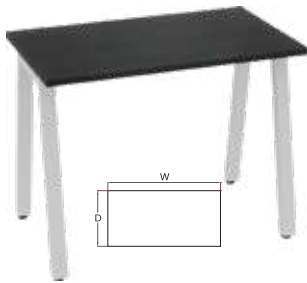

SIDE TABLE

OF-ML-ST10 **RM 448**
W1000*D600*H750 MM



STRAIGHT MAIN TABLE

OF-ML-MT4 W1200*D750*H750 MM **RM 538**
OF-ML-MT5 W1500*D750*H750 MM **RM 598**
OF-ML-MT6 W1800*D750*H750 MM **RM 648**

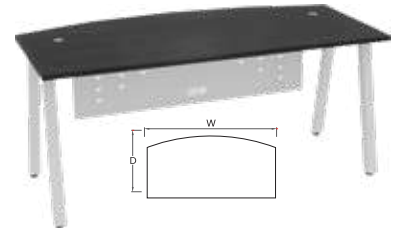

CURVE MAIN TABLE

OF-NT-MTC **RM 728**
W1800*D900*H750 MM

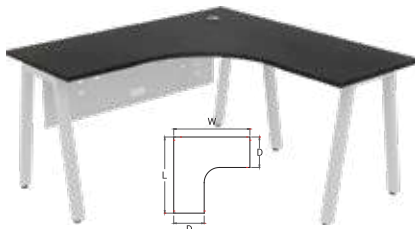

L-SHAPE TABLE

OF-ML-LS15 **RM 868**
W1500*D600*L1500*D600*H750 MM
OF-ML-LS18 **RM 998**
W1800*D600*L1800*D600*H750 MM

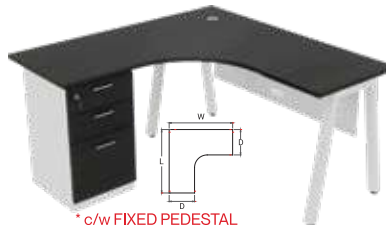

**EXECUTIVE
L-SHAPE TABLE**

OF-ML-LS15FP **RM 998**
W1500*D600*L1500*D600*H750 MM
OF-ML-LS18FP **RM 1,138**
W1800*D600*L1800*D600*H750 MM

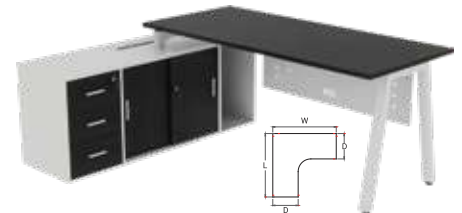

DIRECTOR SET

OF-L18751545LML **RM 1,788**
W1800*D750*W1500*D450*H750 MM



CLUSTER WORKSTATION SERIES

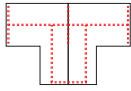
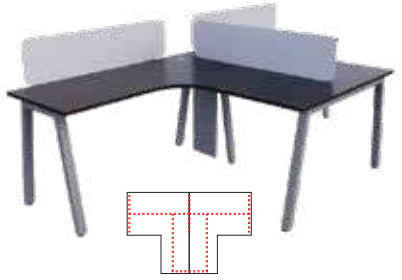

OF-ML-VR-2
W3016 * D1516 * H750 MM
RM 1,898

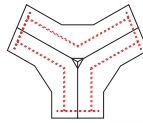
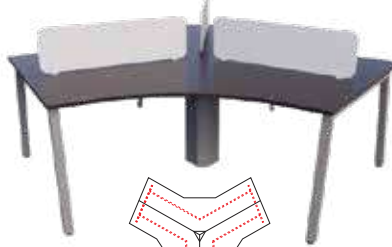

OF-ML-VR-3
W2696 * D2336 * H750 MM
RM 2,798

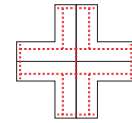
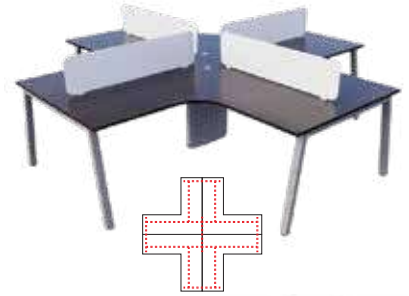

OF-ML-VR-4
W3016 * D3016 * H750 MM
RM 3,668



Technical Specification

Top Surface : 25mm thk melamine laminated chipboard in **ASSORTED COLOUR**

Table Leg : 50mm x 50mm metal leg in **ASSORTED COLOUR**

Colour Option



Leg Colour Option



WITHOUT WIRE RISER (exclude wooden panel & socket box)

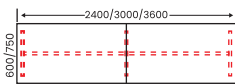

ML LEG CONCEPT - 2 PAX SIDE BY SIDE

MODEL	SIZE (W*D*H) (mm)	PRICE
C2-D2460-MLBLK	2400*600*750	RM 778
C2-D3060-MLBLK	3000*600*750	RM 918
C2-D3660-MLBLK	3600*600*750	RM 968
C2-D2475-MLBLK	2400*750*750	RM 888
C2-D3075-MLBLK	3000*750*750	RM 1,098
C2-D3675-MLBLK	3600*750*750	RM 1,168

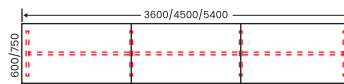

ML LEG CONCEPT - 3 PAX SIDE BY SIDE

MODEL	SIZE (W*D*H) (mm)	PRICE
C3-D3660-MLBLK	3600*600*750	RM 1,098
C3-D4560-MLBLK	4500*600*750	RM 1,308
C3-D5460-MLBLK	5400*600*750	RM 1,388
C3-D3675-MLBLK	3600*750*750	RM 1,265
C3-D4575-MLBLK	4500*750*750	RM 1,568
C3-D5475-MLBLK	5400*750*750	RM 1,668

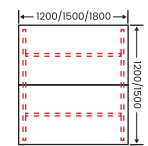

ML LEG CONCEPT - 2 PAX FACE TO FACE

MODEL	SIZE (W*D*H) (mm)	PRICE
C2-D1212-MLBLK	1200*1200*750	RM 748
C2-D1512-MLBLK	1500*1200*750	RM 888
C2-D1812-MLBLK	1800*1200*750	RM 938
C2-D1215-MLBLK	1200*1500*750	RM 868
C2-D1515-MLBLK	1500*1500*750	RM 1,068
C2-D1815-MLBLK	1800*1500*750	RM 1,128

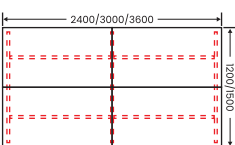

ML LEG CONCEPT - 4 PAX FACE TO FACE

MODEL	SIZE (W*D*H) (mm)	PRICE
C4-D2412-MLBLK	2400*1200*750	RM 1,288
C4-D3012-MLBLK	3000*1200*750	RM 1,578
C4-D3612-MLBLK	3600*1200*750	RM 1,678
C4-D2415-MLBLK	2400*1500*750	RM 1,518
C4-D3015-MLBLK	3000*1500*750	RM 1,928
C4-D3615-MLBLK	3600*1500*750	RM 2,058

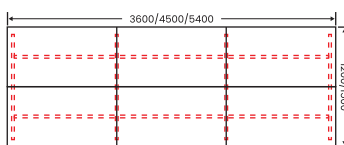

ML LEG CONCEPT - 6 PAX FACE TO FACE

MODEL	SIZE (W*D*H) (mm)	PRICE
C6-D3612-MLBLK	3600*1200*750	RM 1,838
C6-D4512-MLBLK	4500*1200*750	RM 2,268
C6-D5412-MLBLK	5400*1200*750	RM 2,428
C6-D3615-MLBLK	3600*1500*750	RM 2,168
C6-D4515-MLBLK	4500*1500*750	RM 2,778
C6-D5415-MLBLK	5400*1500*750	RM 2,978

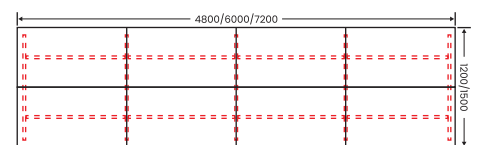

ML LEG CONCEPT - 8 PAX FACE TO FACE

MODEL	SIZE (W*D*H) (mm)	PRICE
C8-D4812-MLBLK	4800*1200*750	RM 2,388
C8-D6012-MLBLK	6000*1200*750	RM 2,968
C8-D7212-MLBLK	7200*1200*750	RM 3,168
C8-D4815-MLBLK	4800*1500*750	RM 2,828
C8-D6015-MLBLK	6000*1500*750	RM 3,638
C8-D7215-MLBLK	7200*1500*750	RM 3,898

WITH WIRE RISER (exclude wooden panel & socket box)

MODEL	SIZE (W*D*H) (mm)	PRICE
C4-D2412WR-MLBLK	2400*1200*750	RM 1,468
C4-D3012WR-MLBLK	3000*1200*750	RM 1,758
C4-D3612WR-MLBLK	3600*1200*750	RM 1,858
C4-D2415WR-MLBLK	2400*1500*750	RM 1,688
C4-D3015WR-MLBLK	3000*1500*750	RM 2,098
C4-D3615WR-MLBLK	3600*1500*750	RM 2,228

MODEL	SIZE (W*D*H) (mm)	PRICE
C6-D3612WR-MLBLK	3600*1200*750	RM 2,198
C6-D4512WR-MLBLK	4500*1200*750	RM 2,628
C6-D5412WR-MLBLK	5400*1200*750	RM 2,788
C6-D3615WR-MLBLK	3600*1500*750	RM 2,508
C6-D4515WR-MLBLK	4500*1500*750	RM 3,128
C6-D5415WR-MLBLK	5400*1500*750	RM 3,318

MODEL	SIZE (W*D*H) (mm)	PRICE
C8-D4812WR-MLBLK	4800*1200*750	RM 2,928
C8-D6012WR-MLBLK	6000*1200*750	RM 3,498
C8-D7212WR-MLBLK	7200*1200*750	RM 3,708
C8-D4815WR-MLBLK	4800*1500*750	RM 3,338
C8-D6015WR-MLBLK	6000*1500*750	RM 4,148
C8-D7215WR-MLBLK	7200*1500*750	RM 4,408

FUZZE

SERIES

WARM ROVERE
WHITE



Technical Specification

TOP SURFACE : 25mm thk melamine chipboard in WARM ROVERE colour
TABLE LEG : 75mm*25mm metal leg in EPOXY WHITE colour
MODESTY : Steel
EDGING : 2mm thk PVC in WARM ROVERE colour for top surface

Colour Option

Top Colour : ● WALNUT ● CELTIC ASH ● ACACIA ● SHIMO ASH ● LADINIA ● LIFE OAK

Leg : ○ WHITE ● BLACK

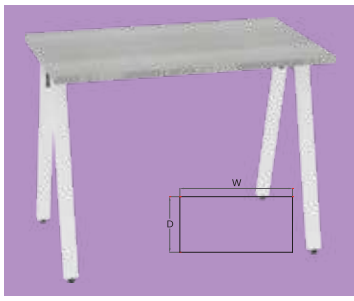

SIDE TABLE

OF-FZ-ST

W1000*D600*H750 MM

RM 598



STRAIGHT MAIN TABLE

OF-FZ-MT4

W1200*D750*H750 MM

RM 698

OF-FZ-MT5

W1500*D750*H750 MM

RM 818

OF-FZ-MT6

W1800*D750*H750 MM

RM 868

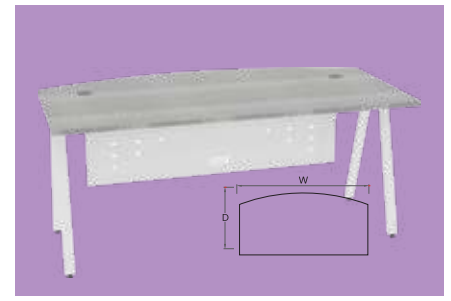

CURVE MAIN TABLE

OF-FZ-MTC

W1800*D900*H750 MM

RM 1,058

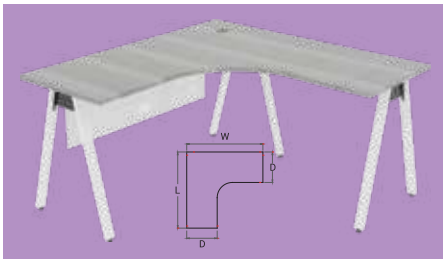

L-SHAPE TABLE

OF-FZ-LS15

W1500*D600*L1500*D600*H750 MM

RM 1,158

OF-FZ-LS18

W1800*D600*L1800*D600*H750 MM

RM 1,208

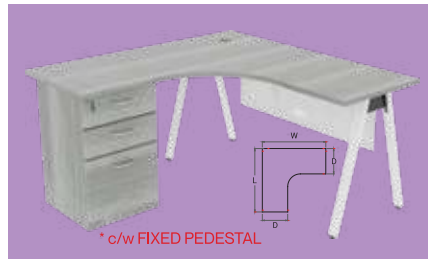

EXECUTIVE L-SHAPE TABLE

OF-FZ-LS15FP

W1500*D600*L1500*D600*H750 MM

RM 1,178

*Fixed Pedestal : W405*D495*H725 MM

OF-FZ-LS18FP

W1800*D600*L1800*D600*H750 MM

RM 1,398

*Fixed Pedestal : W405*D495*H725 MM

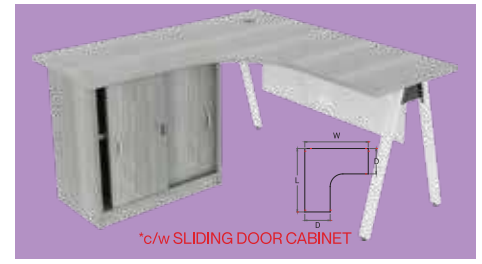

EXECUTIVE L-SHAPE TABLE

OF-FZ-LS15FC

W1500*D600*L1500*D600*H750 MM

RM 1,238

*Fixed Sliding Door Cabinet : W746*D390*H725 MM

OF-FZ-LS18FC

W1800*D600*L1800*D600*H750 MM

RM 1,498

*Fixed Sliding Door Cabinet : W896*D390*H725 MM



CLUSTER WORKSTATION SERIES



OF-FZ-VR-2
W3016 * D1516 * H750 MM
RM 2,968



OF-FZ-VR-3
W2696 * D2336 * H750 MM
RM 2,988



OF-FZ-VR-4
W3016 * D3016 * H750 MM
RM 3,828



Technical Specification

Top Surface : 25mm thk melamine laminated chipboard in **ASSORTED COLOUR**

Table Leg : 75mm x 25mm metal leg in **ASSORTED COLOUR**

Colour Option



Leg Colour Option



WITHOUT WIRE RISER (exclude wooden panel & socket box)

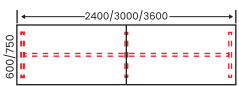

FZ LEG CONCEPT - 2 PAX SIDE BY SIDE

MODEL	SIZE (W*D*H) (mm)	PRICE
C2-D2460-FZWH	2400*600*750	RM 998
C2-D3060-FZWH	3000*600*750	RM 1138
C2-D3660-FZWH	3600*600*750	RM 1208
C2-D2475-FZWH	2400*750*750	RM 1080
C2-D3075-FZWH	3000*750*750	RM 1288
C2-D3675-FZWH	3600*750*750	RM 1368

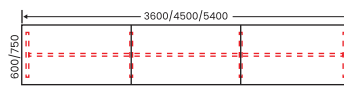

FZ LEG CONCEPT - 3 PAX SIDE BY SIDE

MODEL	SIZE (W*D*H) (mm)	PRICE
C3-D3660-FZWH	3600*600*750	RM 1378
C3-D4560-FZWH	4500*600*750	RM 1598
C3-D5460-FZWH	5400*600*750	RM 1708
C3-D3675-FZWH	3600*750*750	RM 1518
C3-D4575-FZWH	4500*750*750	RM 1828
C3-D5475-FZWH	5400*750*750	RM 1948

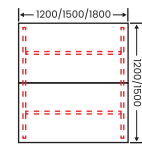

FZ LEG CONCEPT - 2 PAX FACE TO FACE

MODEL	SIZE (W*D*H) (mm)	PRICE
C2-D1212-FZWH	1200*1200*750	RM 948
C2-D1512-FZWH	1500*1200*750	RM 1088
C2-D1812-FZWH	1800*1200*750	RM 1158
C2-D1215-FZWH	1200*1500*750	RM 1038
C2-D1515-FZWH	1500*1500*750	RM 1238
C2-D1815-FZWH	1800*1500*750	RM 1328

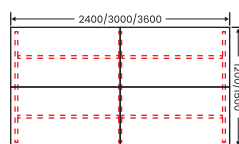

FZ LEG CONCEPT - 4 PAX FACE TO FACE

MODEL	SIZE (W*D*H) (mm)	PRICE
C4-D2412-FZWH	2400*1200*750	RM 1598
C4-D3012-FZWH	3000*1200*750	RM 1888
C4-D3612-FZWH	3600*1200*750	RM 2028
C4-D2415-FZWH	2400*1500*750	RM 1778
C4-D3015-FZWH	3000*1500*750	RM 2188
C4-D3615-FZWH	3600*1500*750	RM 2348

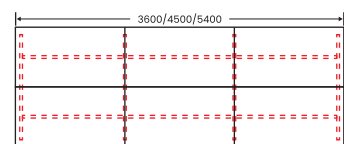

FZ LEG CONCEPT - 6 PAX FACE TO FACE

MODEL	SIZE (W*D*H) (mm)	PRICE
C6-D3612-FZWH	3600*1200*750	RM 2238
C6-D4512-FZWH	4500*1200*750	RM 2678
C6-D5412-FZWH	5400*1200*750	RM 2888
C6-D3615-FZWH	3600*1500*750	RM 2508
C6-D4515-FZWH	4500*1500*750	RM 3128
C6-D5415-FZWH	5400*1500*750	RM 3378

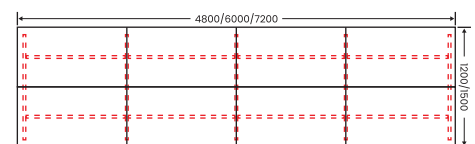

FZ LEG CONCEPT - 8 PAX FACE TO FACE

MODEL	SIZE (W*D*H) (mm)	PRICE
C8-D4812-FZWH	4800*1200*750	RM 2888
C8-D6012-FZWH	6000*1200*750	RM 3468
C8-D7212-FZWH	7200*1200*750	RM 3748
C8-D4815-FZWH	4800*1500*750	RM 3248
C8-D6015-FZWH	6000*1500*750	RM 4068
C8-D7215-FZWH	7200*1500*750	RM 4408

WITH WIRE RISER (exclude wooden panel & socket box)

MODEL	SIZE (W*D*H) (mm)	PRICE
C4-D2412WR-FZWH	2400*1200*750	RM 1678
C4-D3012WR-FZWH	3000*1200*750	RM 1968
C4-D3612WR-FZWH	3600*1200*750	RM 2108
C4-D2415WR-FZWH	2400*1500*750	RM 1898
C4-D3015WR-FZWH	3000*1500*750	RM 2308
C4-D3615WR-FZWH	3600*1500*750	RM 2468

MODEL	SIZE (W*D*H) (mm)	PRICE
C6-D3612WR-FZWH	3600*1200*750	RM 2408
C6-D4512WR-FZWH	4500*1200*750	RM 2848
C6-D5412WR-FZWH	5400*1200*750	RM 3058
C6-D3615WR-FZWH	3600*1500*750	RM 2748
C6-D4515WR-FZWH	4500*1500*750	RM 3368
C6-D5415WR-FZWH	5400*1500*750	RM 3618

MODEL	SIZE (W*D*H) (mm)	PRICE
C8-D4812WR-FZWH	4800*1200*750	RM 3138
C8-D6012WR-FZWH	6000*1200*750	RM 3718
C8-D7212WR-FZWH	7200*1200*750	RM 3998
C8-D4815WR-FZWH	4800*1500*750	RM 3608
C8-D6015WR-FZWH	6000*1500*750	RM 4428
C8-D7215WR-FZWH	7200*1500*750	RM 4768

N I S T R A I I S E R I E S

ACACIA

BLACK



Technical Specification

TOP SURFACE : 25mm thk melamine chipboard in ACACIA colour
TABLE LEG : Steel leg in BLACK colour
MODESTY : Steel
EDGING : 2mm thk PVC in ACACIA colour for top surface

Colour Option

Top Colour : MAPLE HAZEL DARK GREY TEAK BLACK ALON HAMPSHIRE WHITE

Leg : WHITE BLACK

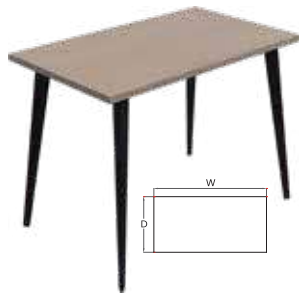

SIDE TABLE

OF-NT-ST

W1000*D600*H750 MM

RM 678



STRAIGHT MAIN TABLE

OF-NT-MT4

W1200*D750*H750 MM

RM 768

OF-NT-MT5

W1500*D750*H750 MM

RM 898

OF-NT-MT6

W1800*D750*H750 MM

RM 968



CURVE MAIN TABLE

OF-NT-MTC

W1800*D900*H750 MM

RM 1,018

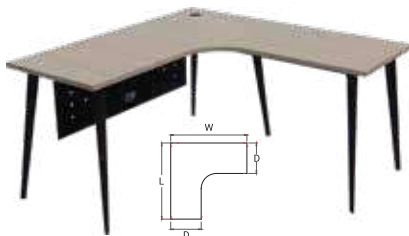

L-SHAPE TABLE

OF-NT-LS15

W1500*D600*L1500*D600*H750 MM

RM 1,238

OF-NT-LS18

W1800*D600*L1800*D600*H750 MM

RM 1,358



* c/w FIXED PEDESTAL

EXECUTIVE
L-SHAPE TABLE

OF-NT-LS15FP

W1500*D600*L1500*D600*H750 MM

RM 1,248

OF-NT-LS18FP

W1800*D600*L1800*D600*H750 MM

RM 1,338



ROUND TABLE

OF-NT-R90

Ø900*H750 MM

RM 648

OF-NT-R1200

Ø1200*H750 MM

RM 878

OF-NT-R1500

Ø1500*H750 MM

RM 1,188



CLUSTER WORKSTATION SERIES



OF-NT-VR-2
W3016 * D1516 * H750 MM
RM 2,998



OF-NT-VR-3
W2696 * D2336 * H750 MM
RM 3,198



OF-NT-VR-4
W3016 * D3016 * H750 MM
RM 3,788



Technical Specification

Top Surface : 25mm thk melamine laminated chipboard in **ASSORTED COLOUR**

Table Leg : Steel leg in **ASSORTED COLOUR**

Colour Option



Leg Colour Option



WITHOUT WIRE RISER (exclude wooden panel & socket box)

NT LEG CONCEPT - 2 PAX SIDE BY SIDE

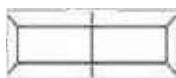

MODEL	SIZE (W*D*H) (mm)	PRICE
C2-D2475-NTWH	2400*750*750	RM 1,368
C2-D3075-NTWH	3000*750*750	RM 1,638
C2-D3675-NTWH	3600*750*750	RM 1,758

NT LEG CONCEPT - 3 PAX SIDE BY SIDE



MODEL	SIZE (W*D*H) (mm)	PRICE
C3-D3675-NTWH	3600*750*750	RM 1,898
C3-D4575-NTWH	4500*750*750	RM 2,298
C3-D5475-NTWH	5400*750*750	RM 2,488

NT LEG CONCEPT - 4 PAX SIDE BY SIDE

MODEL	SIZE (W*D*H) (mm)	PRICE
C3-D4875-NTWH	4800*750*750	RM 2,458
C3-D6075-NTWH	6000*750*750	RM 2,988
C3-D7275-NTWH	7200*750*750	RM 3,228

NT LEG CONCEPT - 2 PAX FACE TO FACE

MODEL	SIZE (W*D*H) (mm)	PRICE
C2-D1212-NTWH	1200*1200*750	RM 898
C2-D1512-NTWH	1500*1200*750	RM 1,058
C2-D1812-NTWH	1800*1200*750	RM 1,138
C2-D1215-NTWH	1200*1500*750	RM 1,028
C2-D1515-NTWH	1500*1500*750	RM 1,248
C2-D1815-NTWH	1800*1500*750	RM 1,338

WITHOUT WIRE RISER (exclude wooden panel & socket box)



NT LEG CONCEPT - 4 PAX FACE TO FACE

MODEL	SIZE (W*D*H) (mm)	PRICE
C4-D2412-NTWH	2400*1200*750	RM 1,538
C4-D3012-NTWH	3000*1200*750	RM 1,858
C4-D3612-NTWH	3600*1200*750	RM 2,028
C4-D2415-NTWH	2400*1500*750	RM 1,788
C4-D3015-NTWH	3000*1500*750	RM 2,228
C4-D3615-NTWH	3600*1500*750	RM 2,398

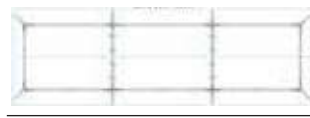

NT LEG CONCEPT - 6 PAX FACE TO FACE

MODEL	SIZE (W*D*H) (mm)	PRICE
C6-D3612-NTWH	3600*1200*750	RM 2,188
C6-D4512-NTWH	4500*1200*750	RM 2,668
C6-D5412-NTWH	5400*1200*750	RM 2,898
C6-D3615-NTWH	3600*1500*750	RM 2,518
C6-D4515-NTWH	4500*1500*750	RM 3,198
C6-D5415-NTWH	5400*1500*750	RM 3,398

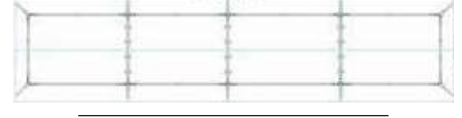

NT LEG CONCEPT - 8 PAX FACE TO FACE

MODEL	SIZE (W*D*H) (mm)	PRICE
C8-D4812-NTWH	4800*1200*750	RM 2,828
C8-D6012-NTWH	6000*1200*750	RM 3,458
C8-D7212-NTWH	7200*1200*750	RM 3,768
C8-D4815-NTWH	4800*1500*750	RM 3,268
C8-D6015-NTWH	6000*1500*750	RM 4,148
C8-D7215-NTWH	7200*1500*750	RM 4,438

WITH WIRE RISER (exclude wooden panel & socket box)

MODEL	SIZE (W*D*H) (mm)	PRICE
C4-D2412WR-NTWH	2400*1200*750	RM 1,848
C4-D3012WR-NTWH	3000*1200*750	RM 2,188
C4-D3612WR-NTWH	3600*1200*750	RM 2,388
C4-D2415WR-NTWH	2400*1500*750	RM 1,938
C4-D3015WR-NTWH	3000*1500*750	RM 2,388
C4-D3615WR-NTWH	3600*1500*750	RM 2,568

MODEL	SIZE (W*D*H) (mm)	PRICE
C6-D3612WR-NTWH	3600*1200*750	RM 2,468
C6-D4512WR-NTWH	4500*1200*750	RM 2,948
C6-D5412WR-NTWH	5400*1200*750	RM 3,188
C6-D3615WR-NTWH	3600*1500*750	RM 2,778
C6-D4515WR-NTWH	4500*1500*750	RM 3,448
C6-D5415WR-NTWH	5400*1500*750	RM 3,698

MODEL	SIZE (W*D*H) (mm)	PRICE
C8-D4812WR-NTWH	4800*1200*750	RM 3,248
C8-D6012WR-NTWH	6000*1200*750	RM 3,898
C8-D7212WR-NTWH	7200*1200*750	RM 4,198
C8-D4815WR-NTWH	4800*1500*750	RM 3,638
C8-D6015WR-NTWH	6000*1500*750	RM 4,538
C8-D7215WR-NTWH	7200*1500*750	RM 4,898

*Images provided are for illustration purposes only. *Prices quoted are subject to change without prior notice & while stocks last. *Terms & conditions apply. *While every care is taken in the preparation of this flyer any inaccuracy or omission is much regretted.

IXIA SERIES

MAPLE

WHITE



Technical Specification

TOP SURFACE : 25mm thk melamine chipboard in MAPLE colour
TABLE LEG : Steel leg in WHITE colour
MODESTY : Steel
EDGING : 2mm thk PVC in MAPLE colour for top surface

Colour Option

Top Colour : MAPLE CHERRY TEAK
 BLACK BEECH WHITE

Leg : WHITE BLACK

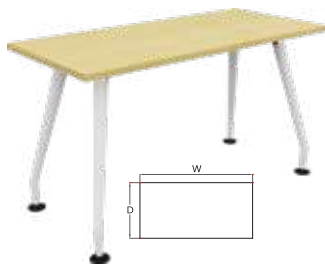

SIDE TABLE

OF-IX-ST

W1000*D600*H750 MM

RM 798



STRAIGHT MAIN TABLE

OF-IX-MT4 W1200*D750*H750 MM

RM 878

OF-IX-MT5 W1500*D750*H750 MM

RM 948

OF-IX-MT6 W1800*D750*H750 MM

RM 998

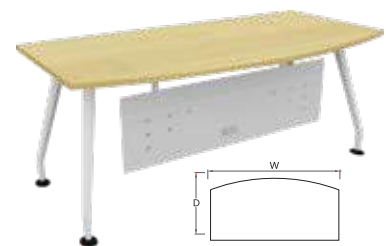

CURVE MAIN TABLE

OF-IX-MTC

W1800*D900*H750 MM

RM 1,088

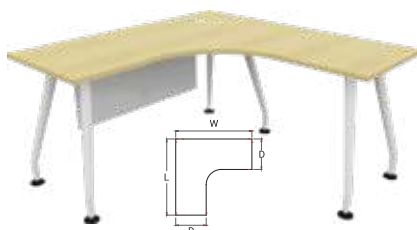

L-SHAPE TABLE

OF-IX-LS15

W1500*D600*L1500*D600*H750 MM

RM 1,498

OF-IX-LS18

W1800*D600*L1800*D600*H750 MM

RM 1,648

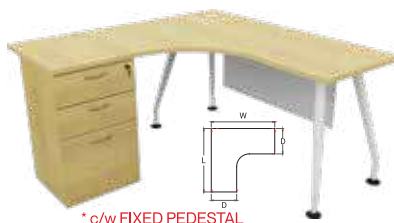

EXECUTIVE
L-SHAPE TABLE

OF-IX-LS15FP

W1500*D600*L1500*D600*H750 MM

RM 1,328

*Fixed Pedestal : W396*D463*H725 MM

OF-IX-LS18FP

W1800*D600*L1800*D600*H750 MM

RM 1,468

*Fixed Pedestal : W396*D463*H725 MM



ROUND DISCUSSION TABLE

OF-IX-R90 Ø900*H750 MM

RM 798

OF-IX-R1200 Ø1200*H750 MM

RM 938

OF-IX-R1500 Ø1500*H750 MM

RM 1,118

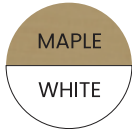

CLUSTER WORKSTATION SERIES



OF-IX-SL-VR-2
W3016 * D1516 * H750 MM
RM 2,928



OF-IX-SL-VR-3
W2696 * D2336 * H750 MM
RM 2,988



OF-IX-SL-VR-4
W3016 * D3016 * H750 MM
RM 3,838



Technical Specification

Top Surface : 25mm thk melamine laminated chipboard in **ASSORTED COLOUR**

Table Leg : Steel leg in **ASSORTED COLOUR**

Colour Option



Leg Colour Option



WITHOUT WIRE RISER (exclude wooden panel & socket box)

IX CHROME LEG CONCEPT - 2 PAX SIDE BY SIDE

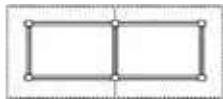

MODEL	SIZE (W*D*H) (mm)	PRICE
C2-D2475-IX-SL	2400*750*750	RM 1,588
C2-D3075-IX-SL	3000*750*750	RM 1,828
C2-D3675-IX-SL	3600*750*750	RM 1,938

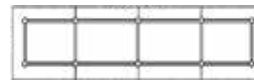

IX CHROME LEG CONCEPT - 3 PAX SIDE BY SIDE



MODEL	SIZE (W*D*H) (mm)	PRICE
C3-D3675-IX-SL	3600*750*750	RM 2,258
C3-D4575-IX-SL	4500*750*750	RM 2,608
C3-D5475-IX-SL	5400*750*750	RM 2,768



IX CHROME LEG CONCEPT - 4 PAX SIDE BY SIDE

MODEL	SIZE (W*D*H) (mm)	PRICE
C3-D4875-IX-SL	4800*750*750	RM 2,928
C3-D6075-IX-SL	6000*750*750	RM 3,398
C3-D7275-IX-SL	7200*750*750	RM 3,608

IX CHROME LEG CONCEPT - 2 PAX FACE TO FACE

MODEL	SIZE (W*D*H) (mm)	PRICE
C2-D1212-IX-SL	1200*1200*750	RM 1,028
C2-D1512-IX-SL	1500*1200*750	RM 1,178
C2-D1812-IX-SL	1800*1200*750	RM 1,248
C2-D1215-IX-SL	1200*1500*750	RM 1,148
C2-D1515-IX-SL	1500*1500*750	RM 1,358
C2-D1815-IX-SL	1800*1500*750	RM 1,438

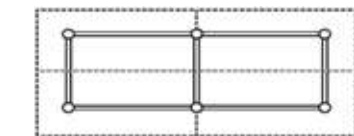

IX CHROME LEG CONCEPT - 4 PAX FACE TO FACE

MODEL	SIZE (W*D*H) (mm)	PRICE
C4-D2412-IX-SL	2400*1200*750	RM 1,788
C4-D3012-IX-SL	3000*1200*750	RM 2,088
C4-D3612-IX-SL	3600*1200*750	RM 2,228
C4-D2415-IX-SL	2400*1500*750	RM 1,998
C4-D3015-IX-SL	3000*1500*750	RM 2,428
C4-D3615-IX-SL	3600*1500*750	RM 2,588

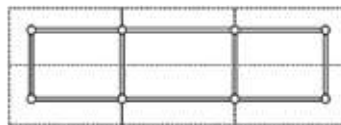

IX CHROME LEG CONCEPT - 6 PAX FACE TO FACE

MODEL	SIZE (W*D*H) (mm)	PRICE
C6-D3612-IX-SL	3600*1200*750	RM 2,538
C6-D4512-IX-SL	4500*1200*750	RM 2,988
C6-D5412-IX-SL	5400*1200*750	RM 3,198
C6-D3615-IX-SL	3600*1500*750	RM 2,858
C6-D4515-IX-SL	4500*1500*750	RM 3,488
C6-D5415-IX-SL	5400*1500*750	RM 3,738

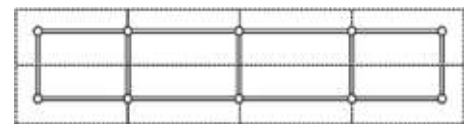

IX CHROME LEG CONCEPT - 8 PAX FACE TO FACE

MODEL	SIZE (W*D*H) (mm)	PRICE
C8-D4812-IX-SL	4800*1200*750	RM 3,288
C8-D6012-IX-SL	6000*1200*750	RM 3,898
C8-D7212-IX-SL	7200*1200*750	RM 4,168
C8-D4815-IX-SL	4800*1500*750	RM 3,718
C8-D6015-IX-SL	6000*1500*750	RM 4,558
C8-D7215-IX-SL	7200*1500*750	RM 4,888

WITH WIRE RISER (exclude wooden panel & socket box)

MODEL	SIZE (W*D*H) (mm)	PRICE
C4-D2412WR-IX-SL	2400*1200*750	RM 1,808
C4-D3012WR-IX-SL	3000*1200*750	RM 2,108
C4-D3612WR-IX-SL	3600*1200*750	RM 2,248
C4-D2415WR-IX-SL	2400*1500*750	RM 2,018
C4-D3015WR-IX-SL	3000*1500*750	RM 2,438
C4-D3615WR-IX-SL	3600*1500*750	RM 2,598

MODEL	SIZE (W*D*H) (mm)	PRICE
C6-D3612WR-IX-SL	3600*1200*750	RM 2,588
C6-D4512WR-IX-SL	4500*1200*750	RM 3,038
C6-D5412WR-IX-SL	5400*1200*750	RM 3,248
C6-D3615WR-IX-SL	3600*1500*750	RM 2,878
C6-D4515WR-IX-SL	4500*1500*750	RM 3,518
C6-D5415WR-IX-SL	5400*1500*750	RM 3,758

MODEL	SIZE (W*D*H) (mm)	PRICE
C8-D4812WR-IX-SL	4800*1200*750	RM 3,368
C8-D6012WR-IX-SL	6000*1200*750	RM 3,978
C8-D7212WR-IX-SL	7200*1200*750	RM 4,248
C8-D4815WR-IX-SL	4800*1500*750	RM 3,748
C8-D6015WR-IX-SL	6000*1500*750	RM 4,598
C8-D7215WR-IX-SL	7200*1500*750	RM 4,928

*Images provided are for illustration purposes only. *Prices quoted are subject to change without prior notice & while stocks last. *Terms & conditions apply. *While every care is taken in the preparation of this flyer any inaccuracy or omission is much regretted.

S M I L E S E R I E S

WALNUT

WHITE



Technical Specification

TOP SURFACE : 25mm thk melamine chipboard in WALNUT colour
TABLE LEG : Steel leg in WHITE colour
MODESTY : Steel
EDGING : 2mm thk PVC in WALNUT colour for top surface

Colour Option

Top Colour :

- TEAK
- ACACIA

- COMFY LATTE (MATT SURFACE)
- SHIMO ASH
- LIFE OAK

Leg :

- WHITE
- BLACK

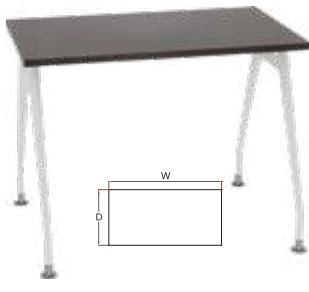

SIDE TABLE

OF-SM-ST

RM 488

W1000*D600*H750 MM



STRAIGHT MAIN TABLE

OF-SM-MT4 W1200*D750*H750 MM

RM 598

OF-SM-MT5 W1500*D750*H750 MM

RM 698

OF-SM-MT6 W1800*D750*H750 MM

RM 748

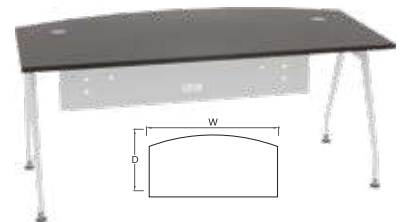

CURVE MAIN TABLE

OF-SM-MTC

RM 778

W1800*D900*H750 MM

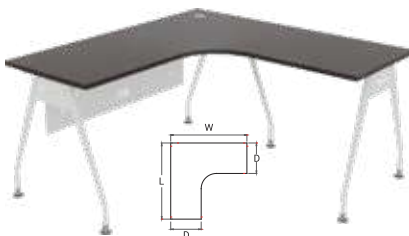

L-SHAPE TABLE

OF-SM-LS15

RM 898

W1500*D600*L1500*D600*H750 MM

OF-SM-LS18

RM 958

W1800*D600*L1800*D600*H750 MM

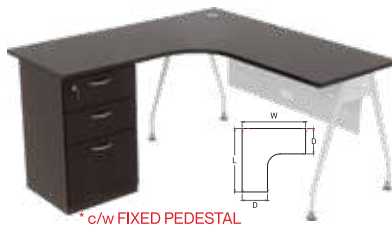

EXECUTIVE L-SHAPE TABLE

OF-SM-LS15FP

RM 999

W1500*D600*L1500*D600*H750 MM

OF-SM-LS18FP

RM 1,038

W1800*D600*L1800*D600*H750 MM



EXECUTIVE TABLE c/w COMBI SLIDING + DRAWER + CPU STORE

OF-L18751545SM

RM 1,888

W1800*D750/W1500*D450*H750 MM

Colour Option

- HAVANA OAK
- SONOMA OAK
- ROCHELLE WHITE
- WILDBIRNE



CLUSTER WORKSTATION SERIES



OF-SM-VR-2
W3016 * D1516 * H750 MM
RM 1,928



OF-SM-VR-3
W2696 * D2336 * H750 MM
RM 3,438



OF-SM-VR-4
W3016 * D3016 * H750 MM
RM 3,688



Technical Specification

Top Surface : 25mm thk melamine laminated chipboard in **ASSORTED COLOUR**

Table Leg : Steel leg in **ASSORTED COLOUR**

Colour Option



Leg Colour Option



WITHOUT WIRE RISER (exclude wooden panel & socket box)

SM LEG CONCEPT - 2 PAX SIDE BY SIDE

MODEL	SIZE (W*D*H) (mm)	PRICE
C2-D2460-SMWH	2400*600*750	RM 788
C2-D3060-SMWH	3000*600*750	RM 938
C2-D3660-SMWH	3600*600*750	RM 998
C2-D2475-SMWH	2400*750*750	RM 878
C2-D3075-SMWH	3000*750*750	RM 1,088
C2-D3675-SMWH	3600*750*750	RM 1,168

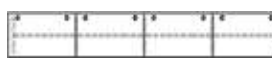
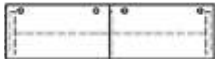

SM LEG CONCEPT - 4 PAX SIDE BY SIDE

MODEL	SIZE (W*D*H) (mm)	PRICE
C4-D4860-SMWH	4800*600*750	RM 1,438
C4-D6060-SMWH	6000*600*750	RM 1,728
C4-D7260-SMWH	7200*600*750	RM 1,858
C4-D4875-SMWH	4800*750*750	RM 1,618
C4-D6075-SMWH	6000*750*750	RM 2,028
C4-D7275-SMWH	7200*750*750	RM 2,178

SM LEG CONCEPT - 3 PAX SIDE BY SIDE

MODEL	SIZE (W*D*H) (mm)	PRICE
C3-D3660-SMWH	3600*600*750	RM 1,118
C3-D4560-SMWH	4500*600*750	RM 1,328
C3-D5460-SMWH	5400*600*750	RM 1,428
C3-D3675-SMWH	3600*750*750	RM 1,248
C3-D4575-SMWH	4500*750*750	RM 1,558
C3-D5475-SMWH	5400*750*750	RM 1,668



SM LEG CONCEPT - 2 PAX FACE TO FACE

MODEL	SIZE (W*D*H) (mm)	PRICE
C2-D1212-SMWH	1200*1200*750	RM 818
C2-D1512-SMWH	1500*1200*750	RM 958
C2-D1812-SMWH	1800*1200*750	RM 1,028
C2-D1215-SMWH	1200*1500*750	RM 1,048
C2-D1515-SMWH	1500*1500*750	RM 1,258
C2-D1815-SMWH	1800*1500*750	RM 1,328

WITHOUT WIRE RISER (exclude wooden panel & socket box)

SM LEG CONCEPT - 4 PAX FACE TO FACE

MODEL	SIZE (W*D*H) (mm)	PRICE
C4-D2412-SMWH	2400*1200*750	RM 1,418
C4-D3012-SMWH	3000*1200*750	RM 1,688
C4-D3612-SMWH	3600*1200*750	RM 1,798
C4-D2415-SMWH	2400*1500*750	RM 1,808
C4-D3015-SMWH	3000*1500*750	RM 2,198
C4-D3615-SMWH	3600*1500*750	RM 2,338



SM LEG CONCEPT - 6 PAX FACE TO FACE

MODEL	SIZE (W*D*H) (mm)	PRICE
C6-D3612-SMWH	3600*1200*750	RM 2,018
C6-D4512-SMWH	4500*1200*750	RM 2,428
C6-D5412-SMWH	5400*1200*750	RM 2,578
C6-D3615-SMWH	3600*1500*750	RM 2,558
C6-D4515-SMWH	4500*1500*750	RM 3,148
C6-D5415-SMWH	5400*1500*750	RM 3,358



SM LEG CONCEPT - 8 PAX FACE TO FACE

MODEL	SIZE (W*D*H) (mm)	PRICE
C8-D4812-SMWH	4800*1200*750	RM 2,618
C8-D6012-SMWH	6000*1200*750	RM 3,158
C8-D7212-SMWH	7200*1200*750	RM 3,368
C8-D4815-SMWH	4800*1500*750	RM 3,318
C8-D6015-SMWH	6000*1500*750	RM 4,108
C8-D7215-SMWH	7200*1500*750	RM 4,368



WITH WIRE RISER (exclude wooden panel & socket box)

MODEL	SIZE (W*D*H) (mm)	PRICE
C4-D2412WR-SMWH	2400*1200*750	RM 1,628
C4-D3012WR-SMWH	3000*1200*750	RM 1,898
C4-D3612WR-SMWH	3600*1200*750	RM 1,998
C4-D2415WR-SMWH	2400*1500*750	RM 1,958
C4-D3015WR-SMWH	3000*1500*750	RM 2,348
C4-D3615WR-SMWH	3600*1500*750	RM 2,478

MODEL	SIZE (W*D*H) (mm)	PRICE
C6-D3612WR-SMWH	3600*1200*750	RM 2,418
C6-D4512WR-SMWH	4500*1200*750	RM 2,828
C6-D5412WR-SMWH	5400*1200*750	RM 2,988
C6-D3615WR-SMWH	3600*1500*750	RM 2,828
C6-D4515WR-SMWH	4500*1500*750	RM 3,438
C6-D5415WR-SMWH	5400*1500*750	RM 3,668

MODEL	SIZE (W*D*H) (mm)	PRICE
C8-D4812WR-SMWH	4800*1200*750	RM 3,228
C8-D6012WR-SMWH	6000*1200*750	RM 3,768
C8-D7212WR-SMWH	7200*1200*750	RM 3,978
C8-D4815WR-SMWH	4800*1500*750	RM 3,748
C8-D6015WR-SMWH	6000*1500*750	RM 4,538
C8-D7215WR-SMWH	7200*1500*750	RM 4,798

VISTA SERIES

SHIMO
ASH
WHITE



Technical Specification

TOP SURFACE : 25mm thk melamine chipboard in SHIMO ASH colour
TABLE LEG : Steel leg in WHITE and CHROME colour
MODESTY : Steel
EDGING : 2mm thk PVC in SHIMO ASH colour for top surface

Colour Option

Top Colour :

- FAGGIONA
- COMFY LATTE (MATT SURFACE)
- TEAK
- ACACIA
- CELTIC ASH
- OAK

Base :

- WHITE
- BLACK
- CHROME (BOTTOM PART)

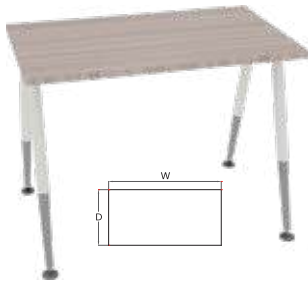

SIDE TABLE

OF-VL-ST

W1000*D600*H750 MM

RM 568



STRAIGHT MAIN TABLE

OF-VL-MT4 W1200*D750*H725 MM

RM 668

OF-VL-MT5 W1500*D750*H725 MM

RM 788

OF-VL-MT6 W1800*D750*H725 MM

RM 838

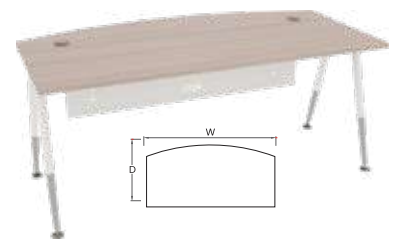

CURVE MAIN TABLE

OF-VL-MTC

W1800*D750*H725 MM

RM 888

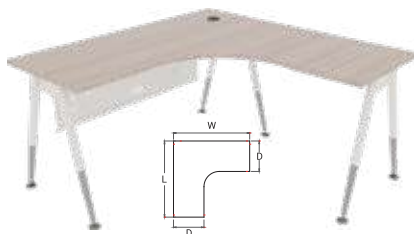

L-SHAPE TABLE

OF-VL-LS15

W1500*D600*L1500*D600*H725 MM

RM 1,088

OF-VL-LS18

W1800*D600*L1800*D600*H725 MM

RM 1,168

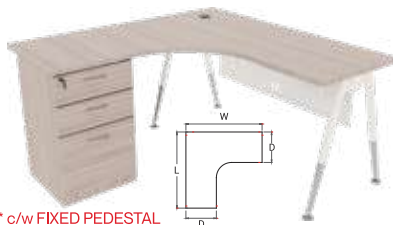

* c/w FIXED PEDESTAL

EXECUTIVE
L-SHAPE TABLE

OF-VL-LS15FP

W1500*D600*L1500*D600*H725 MM

RM 1,178

OF-VL-LS18FP

W1800*D600*L1800*D600*H725 MM

RM 1,248



EXECUTIVE TABLE c/w
COMBI SLIDING + DRAWER + CPU STORE

OF-L18751545VL

W1800*D750/W1500*D450*H750 MM

RM 1,888

Colour Option

- HAVANA OAK
- SONOMA OAK
- ROCHELLE WHITE
- WILDBIRNE



CLUSTER WORKSTATION SERIES



OF-VT-VR-2
W3016 * D1516 * H750 MM
RM 2,108



OF-VT-VR-3
W2696 * D2336 * H750 MM
RM 2,888



OF-VT-VR-4
W3016 * D3016 * H750 MM
RM 3,738



Technical Specification

Top Surface : 25mm thk melamine laminated chipboard in **ASSORTED COLOUR**

Table Leg : Steel leg in **ASSORTED COLOUR**

Colour Option



Leg Colour Option



WITHOUT WIRE RISER (exclude wooden panel & socket box)

VT LEG CONCEPT - 2 PAX SIDE BY SIDE

MODEL	SIZE (W*D*H) (mm)	PRICE
C2-D2460-VTWH	2400*600*750	RM 938
C2-D3060-VTWH	3000*600*750	RM 1,088
C2-D3660-VTWH	3600*600*750	RM 1,148
C2-D2475-VTWH	2400*750*750	RM 1,028
C2-D3075-VTWH	3000*750*750	RM 1,238
C2-D3675-VTWH	3600*750*750	RM 1,308

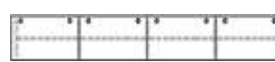
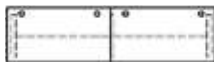

VT LEG CONCEPT - 4 PAX SIDE BY SIDE

MODEL	SIZE (W*D*H) (mm)	PRICE
C4-D4860-VTWH	4800*600*750	RM 1,678
C4-D6060-VTWH	6000*600*750	RM 1,968
C4-D7260-VTWH	7200*600*750	RM 2,098
C4-D4875-VTWH	4800*750*750	RM 1,858
C4-D6075-VTWH	6000*750*750	RM 2,268
C4-D7275-VTWH	7200*750*750	RM 2,428

VT LEG CONCEPT - 3 PAX SIDE BY SIDE

MODEL	SIZE (W*D*H) (mm)	PRICE
C3-D3660-VTWH	3600*600*750	RM 1,308
C3-D4560-VTWH	4500*600*750	RM 1,528
C3-D5460-VTWH	5400*600*750	RM 1,618
C3-D3675-VTWH	3600*750*750	RM 1,448
C3-D4575-VTWH	4500*750*750	RM 1,748
C3-D5475-VTWH	5400*750*750	RM 1,868



VT LEG CONCEPT - 2 PAX FACE TO FACE

MODEL	SIZE (W*D*H) (mm)	PRICE
C2-D1212-VTWH	1200*1200*750	RM 888
C2-D1512-VTWH	1500*1200*750	RM 1,038
C2-D1812-VTWH	1800*1200*750	RM 1,098
C2-D1215-VTWH	1200*1500*750	RM 1,098
C2-D1515-VTWH	1500*1500*750	RM 1,308
C2-D1815-VTWH	1800*1500*750	RM 1,378

WITHOUT WIRE RISER (exclude wooden panel & socket box)

VT LEG CONCEPT - 4 PAX FACE TO FACE

MODEL	SIZE (W*D*H) (mm)	PRICE
C4-D2412-VTWH	2400*1200*750	RM 1,508
C4-D3012-VTWH	3000*1200*750	RM 1,808
C4-D3612-VTWH	3600*1200*750	RM 1,908
C4-D2415-VTWH	2400*1500*750	RM 1,868
C4-D3015-VTWH	3000*1500*750	RM 2,288
C4-D3615-VTWH	3600*1500*750	RM 2,418

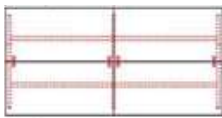

VT LEG CONCEPT - 6 PAX FACE TO FACE

MODEL	SIZE (W*D*H) (mm)	PRICE
C6-D3612-VTWH	3600*1200*750	RM 2,158
C6-D4512-VTWH	4500*1200*750	RM 2,568
C6-D5412-VTWH	5400*1200*750	RM 2,728
C6-D3615-VTWH	3600*1500*750	RM 2,668
C6-D4515-VTWH	4500*1500*750	RM 3,258
C6-D5415-VTWH	5400*1500*750	RM 3,458



VT LEG CONCEPT - 8 PAX FACE TO FACE

MODEL	SIZE (W*D*H) (mm)	PRICE
C8-D4812-VTWH	4800*1200*750	RM 2,788
C8-D6012-VTWH	6000*1200*750	RM 3,338
C8-D7212-VTWH	7200*1200*750	RM 3,548
C8-D4815-VTWH	4800*1500*750	RM 3,458
C8-D6015-VTWH	6000*1500*750	RM 4,238
C8-D7215-VTWH	7200*1500*750	RM 4,498



WITH WIRE RISER (exclude wooden panel & socket box)

MODEL	SIZE (W*D*H) (mm)	PRICE
C4-D2412WR-VTWH	2400*1200*750	RM 1,698
C4-D3012WR-VTWH	3000*1200*750	RM 1,968
C4-D3612WR-VTWH	3600*1200*750	RM 2,078
C4-D2415WR-VTWH	2400*1500*750	RM 2,008
C4-D3015WR-VTWH	3000*1500*750	RM 2,398
C4-D3615WR-VTWH	3600*1500*750	RM 2,528

MODEL	SIZE (W*D*H) (mm)	PRICE
C6-D3612WR-VTWH	3600*1200*750	RM 2,498
C6-D4512WR-VTWH	4500*1200*750	RM 2,898
C6-D5412WR-VTWH	5400*1200*750	RM 3,058
C6-D3615WR-VTWH	3600*1500*750	RM 2,908
C6-D4515WR-VTWH	4500*1500*750	RM 3,498
C6-D5415WR-VTWH	5400*1500*750	RM 3,698

MODEL	SIZE (W*D*H) (mm)	PRICE
C8-D4812WR-VTWH	4800*1200*750	RM 3,288
C8-D6012WR-VTWH	6000*1200*750	RM 3,838
C8-D7212WR-VTWH	7200*1200*750	RM 4,048
C8-D4815WR-VTWH	4800*1500*750	RM 3,808
C8-D6015WR-VTWH	6000*1500*750	RM 4,588
C8-D7215WR-VTWH	7200*1500*750	RM 4,858

MESH SERIES

HAMPSHIRE









Technical Specification

TOP SURFACE : 25mm thk melamine chipboard in HAMPSHIRE colour
TABLE LEG : Steel leg in BLACK colour
MODESTY : Steel
EDGING : 2mm thk PVC in HAMPSHIRE colour for top surface

Colour Option

Top Colour :

-  THUJA LIGHT
-  WALNUT
-  TEAK
-  Base : BLACK
-  CAPPUCINO
-  PORTUNA BLACK
-  HAMPSHIRE

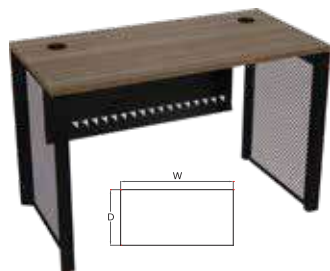

STRAIGHT MAIN TABLE

- OF-MS-MT1260** W1200*D600*H750 MM **RM 1,048**
- OF-MS-MT1560** W1200*D600*H750 MM **RM 1,128**
- OF-MS-MT1860** W1200*D600*H750 MM **RM 1,188**



STRAIGHT MAIN TABLE

- OF-MS-MT4** W1200*D750*H750 MM **RM 1,148**
- OF-MS-MT5** W1500*D750*H750 MM **RM 1,228**
- OF-MS-MT6** W1800*D750*H750 MM **RM 1,308**



RECTANGULAR CONFERENCE TABLE

- OF-MS-R6** W1800*D900*H750 MM **RM 1,598**
- OF-MS-R8** W2400*D1200*H750 MM **RM 1,968**



BOAT SHAPE CONFERENCE TABLE

- OF-MS-B6** **RM 1,598**
W1800*D900*H750 MM
- OF-MS-B8** **RM 2,388**
W2400*D1200*H750 MM

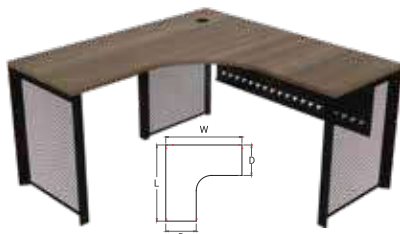

L-SHAPE TABLE

- OF-MS-LS15** **RM 1,688**
W1500*D600*L1500*D600*H750 MM
- OF-MS-LS18** **RM 1,828**
W1800*D600*L1800*D600*H750 MM

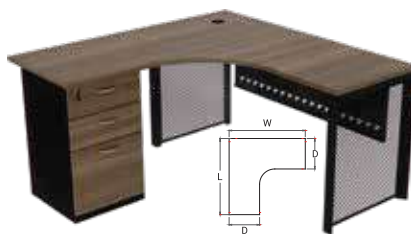

EXECUTIVE L-SHAPE TABLE

- OF-MS-LS15FP** **RM 1,488**
W1500*D600*L1500*D600*H750 MM
*Fixed Pedestal: W746*D390*H725 MM
- OF-MS-LS18FP** **RM 1,688**
W1800*D600*L1800*D600*H750 MM
*Fixed Pedestal: W746*D390*H725 MM

UZUO SERIES

LIFE OAK



Technical Specification

TOP SURFACE : 25mm thk melamine laminated chipboard in LIFE OAK colour
TABLE LEG : 18mm thk melamine laminated chipboard in LIFE OAK colour
MODESTY : 18mm thk melamine laminated chipboard in LIFE OAK colour
EDGING : 2mm thk PVC in LIFE OAK colour for top surface

Colour Option

Top Colour :	LIFE OAK	WHITE OAK	Base :	LIFE OAK	WHITE OAK
	WARM ROVERE	SHIMO ASH		WARM ROVERE	SHIMO ASH

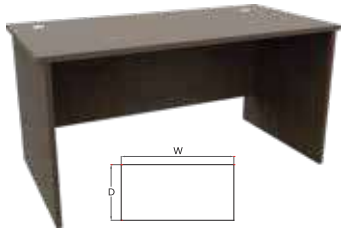

STANDARD TABLE

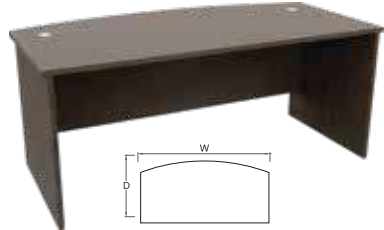

STANDARD CURVE TABLE

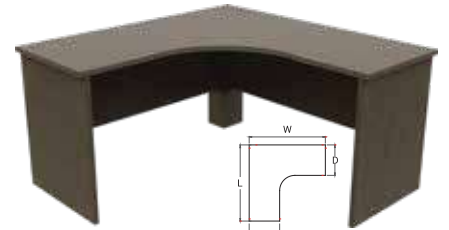

*c/w CHIPBOARD LEG

ERGONOMIC TABLE

- OF-UZ-1274** W1200*D740*H750 MM **RM 338**
- OF-UZ-1574** W1500*D740*H750 MM **RM 448**
- OF-UZ-1874** W1800*D740*H750 MM **RM 478**

- OF-UZ-1890** W1800*D900*H750 MM **RM 528**

- OF-UZ-L1515** W1500*D600*L1500*D600*H750 MM **RM 648**
- OF-UZ-L1818** W1800*D600*L1500*D600*H750 MM **RM 768**



SIDE TABLE

- OF-UZ-90** W900*D450*H750 MM **RM 268**
- OF-UZ-105** W1050*D450*H750 MM **RM 278**



OVAL CONFERENCE TABLE

- OF-UZ-06** W1800*D900*H750 MM **RM 568**
- OF-UZ-08** W2400*D1200*H750 MM **RM 998**



ROUND CONFERENCE TABLE

- OF-UZ-D3** Ø900*H750 MM **RM 398**
- OF-UZ-D4** Ø1200*H750 MM **RM 568**



RECTANGULAR CONFERENCE TABLE

- OF-UZ-R6** W1800*D900*H750 MM **RM 568**
- OF-UZ-R8** W2400*D1200*H750 MM **RM 998**

*Images provided are for illustration purposes only. *Prices quoted are subject to change without prior notice & while stocks last.
 *Terms & conditions apply. *While every care is taken in the preparation of this flyer any inaccuracy or omission is much regretted.



3D MOBILE PEDESTAL
OFLP-MP3D
W400*D450*H525 mm

RM 268



2D1F MOBILE PEDESTAL
OFLP-MP-2D+1F
W400*D470*H660 mm

RM 308



OPEN SHELF LOW CABINET
OFLP-OS9075
W900*D450*H750 mm

RM 278



OPEN SHELF LOW CABINET
OFLP-OS9090
W900*D450*H900 mm

RM 368



OPEN SHELF MEDIUM CABINET
OFLP-OS90120
W900*D450*H1200 mm

RM 398



SWING DOOR LOW CABINET
OFLP-SW9075
W900*D450*H750 mm

RM 368



SWING DOOR LOW CABINET
OFLP-SW9090
W900*D450*H900 mm

RM 488



SWING DOOR MEDIUM CABINET
OFLP-SW90120
W900*D450*H1200 mm

RM 528



SLIDING DOOR LOW CABINET
OFLP-SL-9075
W900*D450*H750 mm

RM 368



SLIDING DOOR LOW CABINET
OFLP-SL-9090
W900*D450*H900 mm

RM 488



SLIDING DOOR MEDIUM CABINET
OFLP-SL-90120
W900*D450*H1200 mm

RM 528



OPEN SHELF HIGH CABINET
OFLP-OS90210
W900*D450*H2100 mm

RM 638



SWING DOOR HIGH CABINET
OFLP-SW90210
W900*D450*H2100 mm

RM 888



HIGH CABINET WITH GLASS DOOR
OFLP-BSC90210
W900*D450*H2100 mm

RM 1,128



LOOP HIGH SWING DOOR CABINET C/W 4 DOORS
OFLP-2SW90210
W900*D450*H2100 mm

RM 1,118



LOOP HIGH SWING DOOR CABINET C/W 4 DOORS
OFLP-2SW90240
W900*D450*H2400 mm

RM 1,208



PLANTER BOX c/w 4 DOOR & PVC BOXES
OFP-SWPB-8011
W800*D400*H1100 mm

RM 718



SWING + SWING DOOR COMBI STORAGE
OFLP-SWSW1575 **OFLP-SWSW1875**
W1500*D410*H750 mm W1800*D410*H750 mm

RM 748

RM 758



SWING + SLIDING DOOR COMBI STORAGE
OFLP-SWSL1575 **OFLP-SWSL1875**
W1500*D410*H750 mm W1800*D410*H750 mm

RM 688

RM 728



SWING DOOR + OPEN SHELF COMBI STORAGE
OFLP-SWOS1575 **OFLP-SWOS1875**
W1500*D410*H750 mm W1800*D410*H750 mm

RM 588

RM 638



SLIDING + SLIDING DOOR COMBI STORAGE
OFLP-SLSL1575 **OFLP-SLSL1875**
W1500*D410*H750 mm W1800*D410*H750 mm

RM 668

RM 718



SLIDING DOOR + OPEN SHELF COMBI STORAGE
OFLP-SLOS1575 **OFLP-SLOS1875**
W1500*D410*H750 mm W1800*D410*H750 mm

RM 578

RM 618



OPEN SHELF + OPEN SHELF COMBI STORAGE
OFLP-OSOS1575 **OFLP-OSOS1875**
W1500*D410*H750 mm W1800*D410*H750 mm

RM 488

RM 518



2D1F PEDESTAL + OPEN SHELF CABINET (FIXED)
OFP-SPOS12075
W1200*D450*H750 mm

RM 428



2D1F PEDESTAL + SLIDING DOOR CABINET (FIXED)
OFP-SPSW12075
W1200*D450*H750 mm

RM 828



2D1F PEDESTAL + SLIDING DOOR CABINET (FIXED)
OFP-SPSL12075
W1200*D450*H750 mm

RM 898

DOOR & DRAWER HEAD



TEAK

BODY SURFACE



TEAK

MOBILE PEDESTAL



2 DRAWERS
OF-ML-M2D
W410*D485*H562
RM 248



3 DRAWERS
OF-ML-M3D
W410*D485*H562
RM 238



HIGH 3 DRAWERS
OF-ML-H3D
W410*D485*H640
RM 278



4 DRAWERS
OF-ML-M4D
W410*D485*H640
RM 278



HIGH 3 DRAWERS
OF-ML-S3D
W410*D485*H750
RM 288



OPEN SHELF CABINET
OF-ML-75-O
W750*D450*H750
RM 238



OPEN SHELF CABINET
OF-ML-906-O
W800*D410*H906
RM 215



OPEN SHELF CABINET
OF-ML-130-O
W900*D450*H1300
RM 448

750/906/1300/1726/2100 HEIGHT CABINET



SWING DOOR CABINET
OF-ML-75-D1
W750*D450*H750
RM 398



SLIDING DOOR CABINET
OF-ML-75-D2
W750*D450*H750
RM 398



SWING DOOR CABINET
OF-ML-906-D1
W800*D410*H906
RM 358



SLIDING DOOR CABINET
OF-ML-906-D2
W800*D410*H906
RM 358



SWING DOOR CABINET
OF-ML-130-D1
W900*D450*H1300
RM 588



SLIDING DOOR CABINET
OF-ML-130-D2
W900*D450*H1300
RM 588



PIGEON HOLES CABINET

OF-ML-906-12P
W800*D410*H906
RM 270



OPEN SHELF CABINET

OF-ML-172-O
W800*D410*H1726
RM 368

OF-ML-210-O
W800*D410*H2100
RM 418



SWING DOOR CABINET

OF-ML-172-D1
W800*D410*H1726
RM 598

OF-ML-210-D1
W800*D410*H2100
RM 738



SWING GLASS DOOR CABINET

OF-ML-172-G1
Swing Glass Door
W800*D410*H1726
RM 598

COMBI STORAGE



SWINGING DOOR + OPEN SHELF CABINET
OF-ML-15M-AC **OF-ML-18M-AC**
W1500*D450*H750 W1800*D450*H750
RM 668 **RM 708**



SLIDING DOOR + OPEN SHELF CABINET
OF-ML-15M-BC **OF-ML-18M-BC**
W1500*D450*H750 W1800*D450*H750
RM 668 **RM 708**



PEDESTAL + OPEN SHELF CABINET
OF-ML-12CE
W1300*D450*H750
RM 658



RIGHT

LEFT

SLIDING DOOR + CPU STORAGE CABINET
OF-ML-12BF
W1200*D500*H750
RM 538



PEDESTAL + SWING DOOR CABINET
OF-ML-12AE
W1300*D450*H750
RM 778



PEDESTAL + SLIDING DOOR CABINET
OF-ML-12BE
W1300*D450*H750
RM 778

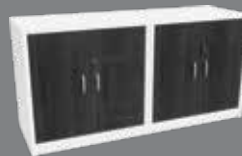

SWING DOOR + SWING DOOR CABINET
OF-ML-15M-AA **OF-ML-18M-AA**
W1500*D450*H750 W1800*D450*H750
RM 798 **RM 858**



SWING DOOR + SLIDING DOOR CABINET
OF-ML-15M-AB **OF-ML-18M-AB**
W1500*D450*H750 W1800*D450*H750
RM 798 **RM 858**



SLIDING DOOR + SLIDING CABINET
OF-ML-15M-BB **OF-ML-18M-BB**
W1500*D450*H750 W1800*D450*H750
RM 798 **RM 858**

DOOR & DRAWER HEAD



CAPPUCCINO



PORTUNA BLACK



ELMER



THUJA LIGHT



WALNUT



COIMBRA

BODY SURFACE



WHITE

MOBILE PEDESTAL



1 DRAWER 1 FILING
OFP-MP1D1F
W411*D500*H550

RM 295



3 DRAWERS
OFP-MP3D
W411*D500*H550

RM 285



2 DRAWERS 1 FILING
OFP-MP2D1F **OFP-MP2D1F(H)**
W411*D500*H645 W411*D500*H706

RM 308

RM 328



2 FILING
OFP-FP2D
W405*D495*H725

RM 318



2 DRAWERS 1 FILING
OFP-FP2D1F
W405*D495*H725

RM 318



4 DRAWERS
OFP-FP4D
W405*D495*H725

RM 338

FIXED PEDESTAL w/o TOP

SLIDING DOOR CABINET



2 LEVELS

OFP-SL-7575
W750*D450*H750

RM 378



2 LEVELS

OFP-SL-7590
W750*D450*H900

RM 418



3 LEVELS

OFP-SL-75120
W750*D450*H1200

RM 548



2 LEVELS

OFP-SW-7575
W750*D450*H750

RM 378



2 LEVELS

OFP-SW-7590
W750*D450*H900

RM 418



3 LEVELS

OFP-SW-75120
W750*D450*H1200

RM 548

OFP-SL-9075
W900*D450*H750

RM 418

OFP-SL-9090
W900*D450*H900

RM 468

OFP-SL-90120
W900*D450*H1200

RM 598

OFP-SW-9075
W900*D450*H750

RM 418

OFP-SW-9090
W900*D450*H900

RM 468

OFP-SW-90120
W900*D450*H1200

RM 598

OFP-SL-10575
W1050*D450*H750

RM 478

OFP-SL-10590
W1050*D450*H900

RM 528

OFP-SL-105120
W1050*D450*H1200

RM 688

OFP-SW-10575
W1050*D450*H750

RM 478

OFP-SW-10590
W1050*D450*H900

RM 528

OFP-SW-105120
W1050*D450*H1200

RM 688

OPEN SHELF CABINET

SWING GLASS DOOR CABINET



2 LEVELS

OFP-OS-7575
W750*D450*H750

RM 338



2 LEVELS

OFP-OS-7590
W750*D450*H900

RM 398



3 LEVELS

OFP-OS-75120
W750*D450*H1200

RM 478



2 LEVELS

OFP-SG-7575
W750*D450*H750

RM 588



2 LEVELS

OFP-SG-7590
W750*D450*H900

RM 678



3 LEVELS

OFP-SG-75120
W750*D450*H1200

RM 888

OFP-OS-9075
W900*D450*H750

RM 398

OFP-OS-9090
W900*D450*H900

RM 448

OFP-OS-90120
W900*D450*H1200

RM 518

OFP-SG-9075
W900*D450*H750

RM 688

OFP-SG-9090
W900*D450*H900

RM 778

OFP-SG-90120
W900*D450*H1200

RM 1,018

OFP-OS-10575
W1050*D450*H750

RM 408

OFP-OS-10590
W1050*D450*H900

RM 468

OFP-OS-105120
W1050*D450*H1200

RM 598

OFP-SG-10575
W1050*D450*H750

RM 778

OFP-SG-10590
W1050*D450*H900

RM 888

OFP-SG-105120
W1050*D450*H1200

RM 1,168

E1 FORMALDEHYDE

COLOUR OPTION

E2 FORMALDEHYDE



WHITE



COMFY LATTE
(MATT SURFACE)



WHITE OAK



WARM ROVERE



SHIMO ASH



LADNIA



IVORY



LIGHT GREY



GRAPHITE



BLACK



CELTIC ASH



FAGGIONA



LIFE OAK



ACACIA



OAK PEGASUS



ICELAND



MAPLE



BEECH



WALNUT

COMBI STORAGE

					
SWING DOOR + SWING DOOR	SWING DOOR + SLIDING DOOR	SWING DOOR + OPEN SHELF	SLIDING DOOR + SLIDING DOOR	SLIDING DOOR + OPEN SHELF	OPEN SHELF + OPEN SHELF
OFP-SWSW1575 W1500*D450*H750 RM 858	OFP-SWSL1575 W1500*D450*H750 RM 858	OFP-SWOS1575 W1500*D450*H750 RM 788	OFP-SLSL1575 W1500*D450*H750 RM 858	OFP-SLOS1575 W1500*D450*H750 RM 788	OFP-OSOS1575 W1800*D450*H750 RM 728
OFP-SWSW1875 W1800*D450*H750 RM 968	OFP-SWSL1875 W1800*D450*H750 RM 968	OFP-SWOS1875 W1800*D450*H750 RM 898	OFP-SLSL1875 W1800*D450*H750 RM 968	OFP-SLOS1875 W1800*D450*H750 RM 898	OFP-OSOS1875 W1800*D450*H750 RM 848

2D1F PEDESTAL c/w FIXED CABINET

					
OPEN SHELF CABINET	SWING DOOR CABINET	SLIDING DOOR CABINET	OPEN SHELF CABINET	SWING DOOR CABINET	SLIDING DOOR CABINET
OFP-SPOS12075 W1200*D450*H750 RM 828	OFP-SPSW12075 W1200*D450*H750 RM 878	OFP-SPSL12075 W1200*D450*H750 RM 888	OFP-MPOS12066 W1200*D450*H662 RM 868	OFP-MPSW12066 W1200*D450*H662 RM 918	OFP-MPSL12066 W1200*D450*H662 RM 938

2D1F PEDESTAL c/w MOBILE CABINET

PIGEON HOLE + SWING DOOR CABINET

	
6 PIGEON HOLES	9 PIGEON HOLES
OFP-SW6PH-90120 W900*D450*H1200 RM 768	OFP-SW9PH-90150 W900*D450*H1500 RM 918

BOOKSHELF ALUMINIUM FRAME DOOR CABINET

	
FULL GLASS DOOR	HALF GLASS DOOR
OFP-FSGC-80180 W800*D450*H1800 RM 1,428	OFP-BSGC-80180 W800*D450*H1800 RM 1,248
OFP-FSGC-90180 W900*D450*H1800 RM 1,518	OFP-BSGC-90210 W900*D450*H2100 RM 1,498
OFP-FSGC-90210 W900*D450*H2100 RM 1,788	OFP-BSGC-90240 W900*D450*H2400 RM 1,788

HIGH CABINET

			
HIGH OPEN SHELF CABINET	BOOKSHELF CABINET	HIGH SWING DOOR CABINET	HIGH SWING DOOR CABINET
4 LEVELS OFP-OS-75180 W750*D450*H1800 RM 658	OFP-BSC-90120 W900*D450*H1200 RM 578	4 LEVELS OFP-SW-80180 W800*D450*H1800 RM 788	4 LEVELS OFP-2SW-90180 W900*D450*H1800 RM 968
4 LEVELS OFP-OS-90180 W900*D450*H1800 RM 698	OFP-BSC-90150 W900*D450*H1500 RM 798	4 LEVELS OFP-SW-90180 W900*D450*H1800 RM 868	5 LEVELS OFP-2SW-90210 W900*D450*H2100 RM 1,198
5 LEVELS OFP-OS-90210 W900*D450*H2100 RM 828	OFP-BSC-80180 W800*D450*H1800 RM 778	5 LEVELS OFP-SW-90210 W900*D450*H2100 RM 1,098	6 LEVELS OFP-2SW-90240 W900*D450*H2400 RM 1,328
	OFP-BSC-90180 W900*D450*H1800 RM 878		
	OFP-BSC-90210 W900*D450*H2100 RM 1,028		

ANSON SERIES

ACACIA
WALNUT
DARK
GREY



Technical Specification

TOP SURFACE : 25mm thk melamine laminated chipboard in ACACIA WALNUT colour
TABLE LEG : TRAPEZOID Metal leg in EPOXY DARK GREY colour
MODESTY : Wooden in DARK GREY colour
EDGING : 2mm thk PVC in ACACIA WALNUT colour for top surface

Colour Option

Top Colour : WHITE CHERRY ACACIA WALNUT LIGHT GREY MAPLE BORAS ASH

Base : WHITE DARK GREY



*w/o MODESTY PANEL & GROMMET HOLES

STRAIGHT MAIN TABLE

OF-AN-MT4(O) W1200*D750*H750 MM **RM 538**
OF-AN-MT5(O) W1500*D750*H750 MM **RM 588**
OF-AN-MT6(O) W1800*D750*H750 MM **RM 628**

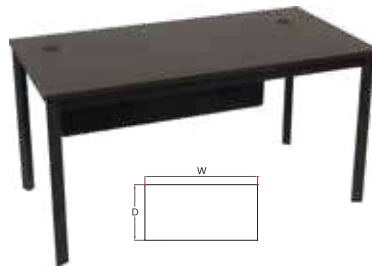

STRAIGHT MAIN TABLE

OF-AN-MT4 W1200*D750*H750 MM **RM 608**
OF-AN-MT5 W1500*D750*H750 MM **RM 668**
OF-AN-MT6 W1800*D750*H750 MM **RM 728**

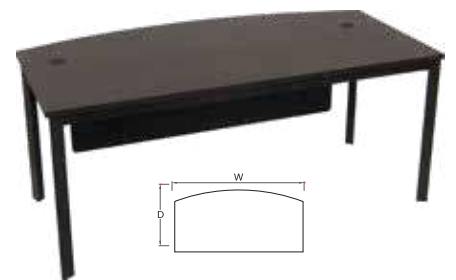

CURVE MAIN TABLE

OF-AN-MTC W1800*D900*H750 MM **RM 788**



L-SHAPE TABLE

OF-AN-LS15 **RM 938**
W1500*D600*L1500*D600*H750 MM
OF-AN-LS18 **RM 978**
W1800*D600*L1800*D600*H750 MM

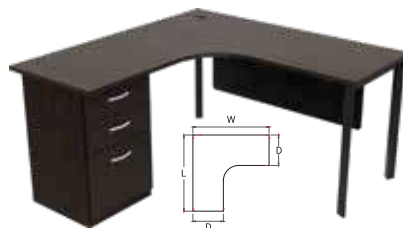

*c/w FIXED PEDESTAL

EXECUTIVE L-SHAPE TABLE

OF-AN-LS15FP **RM 1,068**
W1500*D600*L1500*D600*H750 MM
OF-AN-LS18FP **RM 1,268**
W1800*D600*L1800*D600*H750 MM

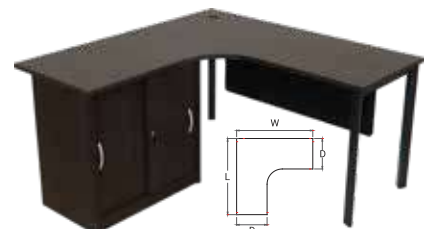

*c/w FIXED SLIDING DOOR CABINET

EXECUTIVE L-SHAPE TABLE

OF-AN-LS15FC **RM 1,148**
W1500*D600*L1500*D600*H750 MM
*Fixed Sliding Door Cabinet : W796*D430*H725 MM
OF-AN-LS18FC **RM 1,368**
W1800*D600*L1800*D600*H750 MM
*Fixed Sliding Door Cabinet : W896*D430*H725 MM

LETO SERIES

BORAS ASH
WHITE



Technical Specification

TOP SURFACE : 25mm thk melamine laminated chipboard in BORAS ASH colour
TABLE LEG : Steel in WHITE colour
MODESTY : Steel in WHITE colour
EDGING : 2mm thk PVC in BORAS ASH colour for top surface

Colour Option

Top Colour : WHITE CHERRY ACACIA WALNUT LIGHT GREY MAPLE BORAS ASH

Base : WHITE



STRAIGHT MAIN TABLE

OF-LT-MT4(O) W1200*D750*H750 MM **RM 528**
OF-LT-MT5(O) W1500*D750*H750 MM **RM 568**
OF-LT-MT6(O) W1800*D750*H750 MM **RM 618**



STRAIGHT MAIN TABLE

OF-LT-MT4 W1200*D750*H750 MM **RM 578**
OF-LT-MT5 W1500*D750*H750 MM **RM 638**
OF-LT-MT6 W1800*D750*H750 MM **RM 698**

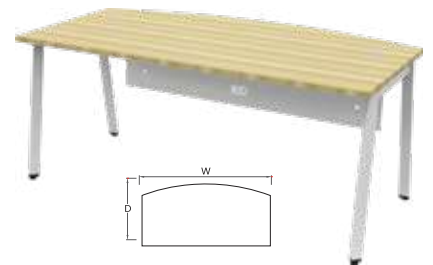

CURVE MAIN TABLE

OF-LT-MTC W1800*D900*H750 MM **RM 748**

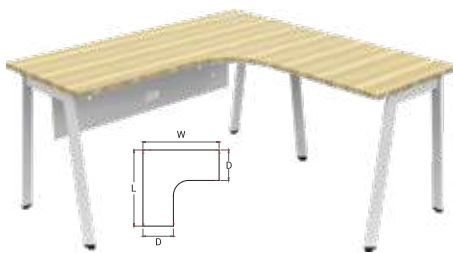

L-SHAPE TABLE

OF-LT-LS15 **RM 898**
W1500*D600*L1500*D600*H750 MM
OF-LT-LS18 **RM 958**
W1800*D600*L1800*D600*H750 MM

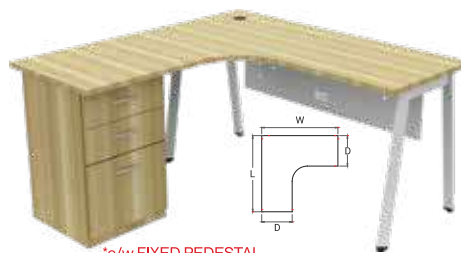

EXECUTIVE L-SHAPE TABLE

OF-LT-LS15FP **RM 1,048**
W1500*D600*L1500*D600*H750 MM
OF-LT-LS18FP **RM 1,098**
W1800*D600*L1800*D600*H750 MM



EXECUTIVE L-SHAPE TABLE

OF-LT-LS15FC **RM 1,148**
W1500*D600*L1500*D600*H750 MM
*Fixed Sliding Door Cabinet : W796*D430*H725 MM
OF-LT-LS18FC **RM 1,188**
W1800*D600*L1800*D600*H750 MM
*Fixed Sliding Door Cabinet : W896*D430*H725 MM

FX SERIES

BORAS
ASH



Technical Specification

TOP SURFACE : 25mm thk melamine chipboard in BORAS ASH colour
TABLE LEG : 16mm thk melamine chipboard in BORAS ASH colour
MODESTY : 16mm thk melamine chipboard in BORAS ASH colour
EDGING : 2mm thk PVC in BORAS ASH colour for top surface

Colour Option

Top Colour :  ACACIA WALNUT  BORAS ASH

Base :  ACACIA WALNUT  BORAS ASH



STANDARD TABLE

- OF-FX-127** W1200*D700*H750 MM **RM 270**
- OF-FX-157** W1500*D700*H750 MM **RM 305**
- OF-FX-187** W1800*D700*H750 MM **RM 375**
- OF-FX-188** W1800*D800*H750 MM **RM 395**

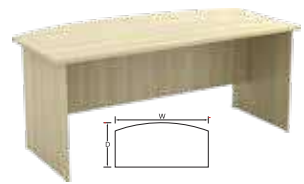

STANDARD CURVE TABLE

- OF-FX-1890** W1200*D700*H750 MM **RM 435**

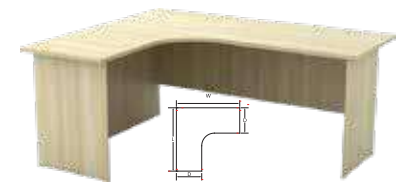

SUPERIOR COMPACT TABLE

- OF-FX-L1515** W1500*D600*W1500*D600*H750 MM **RM 518**
- OF-FX-L1818** W1800*D600*W1500*D600*H750 MM **RM 558**



STANDARD TABLE w/o GROMMET

- OF-FX-126** W1200*D600*H750 MM **RM 250**



RECTANGULAR CONFERENCE TABLE

- OF-FX-R6** W1800*D900*H750 MM **RM 385**
- OF-FX-R8** W2400*D1200*H750 MM **RM 595**



OVAL CONFERENCE TABLE

- OF-FX-O6** W1800*D900*H750 MM **RM 405**
- OF-FX-O8** W2400*D1200*H750 MM **RM 625**



ROUND DISCUSSION TABLE

- OF-FX-D3** W900*D900*H750 MM **RM 250**
- OF-FX-D4** W1200*D1200*H750 MM **RM 375**



SIDE TABLE c/w RACK

- OF-FX-106** W900*D450*H700 MM **RM 245**



COUNTERISER

- OF-FX-C12** W1200*D300*H300 MM **RM 160**
- OF-FX-C15** W1500*D300*H300 MM **RM 180**
- OF-FX-C18** W1800*D300*H300 MM **RM 195**

MOBILE PEDESTAL



1 DRAWER 1 FILING
OF-FX-M2D
W400*D480*H560
RM 245



3 DRAWERS
OF-FX-M3D
W400*D480*H560
RM 240



2 DRAWERS 1 FILING
OF-FX-H3D
W400*D480*H620
RM 298



4 DRAWERS
OF-FX-M4D
W400*D480*H620
RM 298



1 DRAWER 1 FILING
OF-FX-H2
W396*D468*H480
RM 205



3 DRAWERS
OF-FX-H3D
W396*D468*H480
RM 199



2 DRAWERS
OF-FX-RH2
W396*D376*H340
RM 155

750/900/910 HEIGHT CABINET



PIGEON HOLE

OF-FX-910-PG
W800*D400*H910
RM 350



SWINGING GLASS DOOR

OF-FX-910-G1
W800*D400*H910
RM 385



OPEN SHELF CABINET

OF-FX-875-O
W800*D450*H750
RM 290

OF-FX-975-O
W900*D450*H750
RM 310

OF-FX-910-O
W800*D400*H910
RM 285



SWINGING DOOR CABINET

OF-FX-875-D1
W800*D450*H750
RM 370

OF-FX-975-D1
W900*D450*H750
RM 395

OF-FX-910-D1
W800*D400*H910
RM 375



SLIDING DOOR CABINET

OF-FX-875-D2
W800*D450*H750
RM 445

OF-FX-975-D2
W900*D450*H750
RM 470

OF-FX-910-D2
W800*D400*H910
RM 415

1310 / 1710 / 2110 HEIGHT CABINET (3 LEVELS / 4 LEVELS / 5 LEVELS)



SWINGING DOOR CABINET

OF-FX-211-2D1
W800*D400*H2110
RM 788



SWINGING GLASS DOOR CABINET

OF-FX-211-G1
W800*D400*H2110
RM 788



OPEN SHELF CABINET

OF-FX-131-O
W800*D400*H1310
RM 355

OF-FX-171-O
W800*D400*H1710
RM 438

OF-FX-211-O
W800*D400*H2110
RM 518



SWINGING DOOR CABINET

OF-FX-131-D1
W800*D400*H1310
RM 495

OF-FX-171-D1
W800*D400*H1710
RM 628

OF-FX-211-D1
W800*D400*H2110
RM 738



BOOK SHELF CABINET

OF-FX-131-OD1
W800*D400*H1310
RM 470

OF-FX-171-OD1
W800*D400*H1710
RM 558

OF-FX-211-OD1
W800*D400*H2110
RM 638

COMBI STORAGE



OPEN SHELF + FIXED PEDESTAL 2D1F CABINET
OF-FX-12-CE
W1200*D450*H750
RM 588



SWINGING DOOR + FIXED PEDESTAL 2D1F CABINET
OF-FX-12-AE
W1200*D450*H750
RM 698



SLIDING DOOR + FIXED PEDESTAL 2D1F CABINET
OF-FX-12-BE
W1200*D450*H750
RM 748



DUAL OPEN SHELF CABINET
OF-FX-16M-CC **OF-FX-18M-CC**
W1600*D450*H750 W1800*D450*H750
RM 530 **RM 565**



DUAL SWINGING DOOR CABINET
OF-FX-16M-AA **OF-FX-18M-AA**
W1600*D450*H750 W1800*D450*H750
RM 748 **RM 788**



DUAL SLIDING DOOR CABINET
OF-FX-16M-BB **OF-FX-18M-BB**
W1600*D450*H750 W1800*D450*H750
RM 848 **RM 968**



OPEN SHELF + SWINGING DOOR CABINET
OF-FX-16M-AC **OF-FX-18M-AC**
W1600*D450*H750 W1800*D450*H750
RM 688 **RM 728**



OPEN SHELF + SLIDING DOOR CABINET
OF-FX-16M-BC **OF-FX-18M-BC**
W1600*D450*H750 W1800*D450*H750
RM 748 **RM 788**

DOOR & HEAD DRAWER



BORÁS ASH



ACACIA WALNUT

BODY SURFACE



BORÁS ASH



ACACIA WALNUT

FLEXX

II

SERIES

BLACK



Technical Specification

TOP SURFACE : 25mm thk melamine laminated chipboard in **BLACK** colour
TABLE LEG : Steel leg in **SILVER** colour
MODESTY : Steel
EDGING : 2mm thk PVC in **BLACK** colour for top surface

Colour Option

Top Colour : CHERRY MAPLE SILVER
 BEECH BLACK BLACK



STRAIGHT MAIN TABLE

- OF-FL-MT1260** RM 448
W1200*D600*H750 MM
- OF-FL-MT1560** RM 488
W1500*D600*H750 MM
- OF-FL-MT1860** RM 538
W1800*D600*H750 MM



STRAIGHT MAIN TABLE

- OF-FL-MT4** RM 488
W1200*D750*H750 MM
- OF-FL-MT5** RM 538
W1500*D750*H750 MM
- OF-FL-MT6** RM 588
W1800*D750*H750 MM



CURVE MAIN TABLE

- OF-FL-MTC** RM 688
W1800*D900*H750 MM

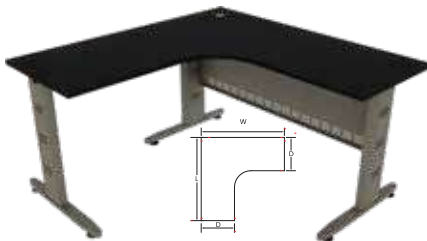

L-SHAPE TABLE

- OF-FL-LS15** RM 758
W1500*D600*L1500*
D600*H750 MM
- OF-FL-LS18** RM 888
W1800*D600*L1800*
D600*H750 MM

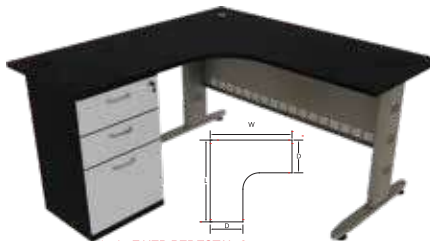

EXECUTIVE L-SHAPE TABLE

- OF-FL-LS15FP** RM 948
W1500*D600*L1500*
D600*H750 MM
- OF-FL-LS18FP** RM 998
W1800*D600*L1800*
D600*H750 MM



FLEXX II CONCEPT

- OF-C2-FLEXX12** RM 1,378
W1200*D1500*H750/1050 MM
- OF-C2-FLEXX15** RM 1,478
W1500*D1500*H750/1050 MM
- OF-C2-FLEXX18** RM 1,598
W1800*D1500*H750/1050 MM

MOBILE PEDESTAL



2 DRAWERS
OF-FL-M2D
W410*D485*H562

RM 245



3 DRAWERS
OF-FL-M3D
W410*D485*H562

RM 235



HIGH 3 DRAWERS
OF-FL-H3D
W410*D485*H640

RM 275



4 DRAWERS
OF-FL-M4D
W410*D485*H640

RM 275

STAND PEDESTAL



HIGH 3 DRAWERS
OF-FL-S3D
W410*D485*H750

RM 315



4 DRAWERS
OF-FL-S4D
W410*D485*H750

RM 315

HANGING PEDESTAL



2 DRAWERS
OF-FL-H2
W393*D446*H487

RM 218



3 DRAWERS
OF-FL-H3
W393*D446*H487

RM 208

FIXED PEDESTAL



HIGH 3 DRAWERS
OF-FL-F2D+1F
W393*D446*H725

RM 297



4 DRAWERS
OF-FL-F4D
W393*D446*H725

RM 297

635/750/900/906 HEIGHT CABINET / * FOR 750 HEIGHT CABINET BODY (D) 390MM



SIDE CABINET
OF-FL-63-D2
W1050*D450*H635

RM 315



PIGEON HOLES CABINET
OF-FL-906-12P
W800*D410*H906

RM 358



OPEN SHELF CABINET

OF-FL-75-O
W750*D450*H750

RM 308

OF-FL-90-O
W900*D450*H900

RM 408

OF-FL-906-O
W800*D410*H906

RM 260



OF-FL-75-D1
W750*D450*H750

RM 375

OF-FL-90-D1
W900*D450*H900

RM 418

OF-FL-906-D1
W800*D410*H906

RM 360



OF-FL-75-D2
W750*D450*H750

RM 375

OF-FL-90-D2
W900*D450*H900

RM 418

OF-FL-906-D2
W800*D410*H906

RM 360

1200 / 1720 / 2100 HEIGHT CABINET (3 LEVELS / 4 LEVELS / 5 LEVELS)



OF-FL-120-D2
W900*D450*H1200

RM 548



OF-FL-172-G1
(WITH GLASS)
W800*D410*H1728

RM 598



OF-FL-120-O
W900*D450*H1200

RM 538

OF-FL-172-O
W800*D410*H1726

RM 478

OF-FL-210-O
W800*D410*H2100

RM 588



OF-FL-120-D1
W900*D450*H1200

RM 548

OF-FL-172-D1
W800*D410*H1726

RM 598

OF-FL-210-D1
W800*D410*H2100

RM 748

SLIDING DOOR CABINET

BOOK SHELF CABINET

OPEN SHELF CABINET

SWINGING DOOR CABINET

COMBI STORAGE



PEDESTAL + SWINGING DOOR CABINET
OF-FL-12AE
W1300*D450*H750

RM 788



PEDESTAL + SLIDING DOOR CABINET
OF-FL-12BE
W1300*D450*H750

RM 768



PEDESTAL + OPEN SHELF CABINET
OF-FL-12CE
W1300*D450*H750

RM 678



LEFT RIGHT

SLIDING DOOR + CPU STORAGE CABINET
OF-FL-12BF
W1200*D500*H750

RM 428



OPEN SHELF + OPEN SHELF CABINET
OF-FL-15M-CC
W1500*D450*H750

RM 658

OF-FL-18M-CC
W1800*D450*H750

RM 758



SWING DOOR + SWING DOOR CABINET
OF-FL-15M-AA
W1500*D450*H750

RM 808

OF-FL-18M-AA
W1800*D450*H750

RM 868



SWING DOOR + SLIDING DOOR CABINET
OF-FL-15M-AB
W1500*D450*H750

RM 808

OF-FL-18M-AB
W1800*D450*H750

RM 868



SWING DOOR + OPEN SHELF CABINET
OF-FL-15M-AC
W1500*D450*H750

RM 698

OF-FL-18M-AC
W1800*D450*H750

RM 768



SLIDING DOOR + SLIDING DOOR CABINET
OF-FL-15M-BB
W1500*D450*H750

RM 808

OF-FL-18M-BB
W1800*D450*H750

RM 868



SLIDING DOOR + OPEN SHELF CABINET
OF-FL-15M-BC
W1500*D450*H750

RM 698

OF-FL-18M-BC
W1800*D450*H750

RM 768

Body Colour



BLACK



CHERRY



MAPLE



BEECH

Door & Head Drawer



WHITE



LIGHT GREY

HAWK

SERIES

WHITE



Technical Specification

TOP SURFACE : 25mm thk melamine laminated chipboard in WHITE colour
TABLE LEG : Steel leg in WHITE colour only
MODESTY : Wooden
EDGING : 2mm thk PVC in WHITE colour for top surface

Colour Option

Top Colour :  WHITE

Base :  FULLY WHITE

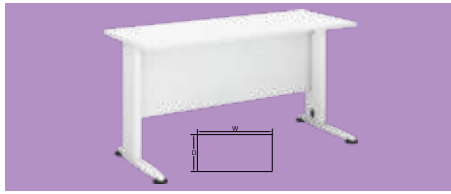

STANDARD TABLE w/o GROMMET

- OF-HW-MT126** W1200*D600*H750 MM **RM 358**
- OF-HW-MT156** W1500*D600*H750 MM **RM 388**



STANDARD TABLE

- OF-HW-MT128** W1200*D800*H750 MM **RM 378**
- OF-HW-MT158** W1500*D800*H750 MM **RM 418**
- OF-HW-MT188** W1800*D800*H750 MM **RM 478**

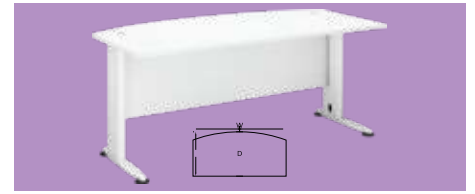

EXECUTIVE TABLE

- OF-HW-D1890** W1800*D900*H750 MM **RM 518**

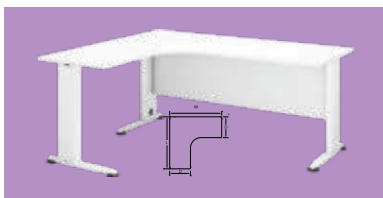

SUPERIOR COMPACT TABLE

- OF-HW-LS15** **RM 638**
W1500*D700*W1500*D600*H750 MM
- OF-HW-LS18** **RM 678**
W1800*D700*W1500*D600*H750 MM

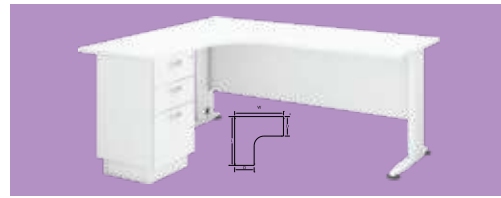

SUPERIOR COMPACT TABLE

- OF-HW-LS15FP-3** **RM 798**
W1500*D700*W1500*D600*H750 MM
- OF-HW-LS18FP-3** **RM 838**
W1800*D700*W1500*D600*H750 MM



RECTANGULAR CONFERENCE TABLE

- OF-HW-R6** W1800*D900*H750 MM **RM 478**
- OF-HW-R8** W2400*D1200*H750 MM **RM 638**



OVAL CONFERENCE TABLE

- OF-HW-O3012** W3000*D1200*H750 MM **RM 1,578**



BOAT-SHAPE CONFERENCE TABLE

- OF-HW-B3012** W3000*D1200/900*H750 MM **RM 1,448**



OVAL CONFERENCE TABLE

- OF-HW-O6** **RM 498**
W1800*D900*H750 MM
- OF-HW-O8** **RM 678**
W2400*D1200*H750 MM

NOVA SERIES

WHITE

Technical Specification

TOP SURFACE : 25mm thk melamine laminated chipboard in **WHITE** colour
TABLE LEG : 50mm*50mm metal leg in **EPOXY WHITE** colour
MODESTY : Steel
EDGING : 2mm thk PVC in **WHITE** colour for top surface

Colour Option

Top Colour : LIGHT GREY WHITE
Base : WHITE

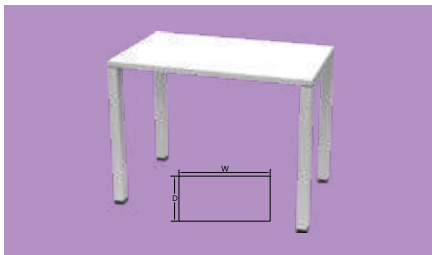

SIDE TABLE

OF-NV-ST W1000*D600*H750 MM **RM 398**

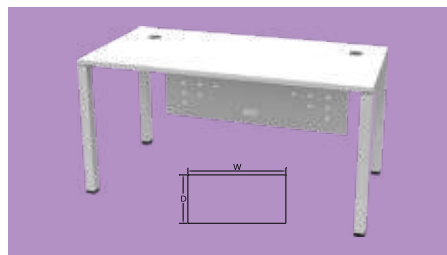

STRAIGHT MAIN TABLE

OF-NV-MT4 W1200*D750*H750 MM **RM 438**

OF-NV-MT5 W1500*D750*H750 MM **RM 488**

OF-NV-MT6 W1800*D750*H750 MM **RM 538**

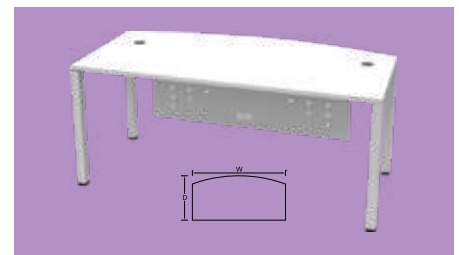

CURVE MAIN TABLE

OF-NV-MTC W1800*D900*H750 MM **RM 608**

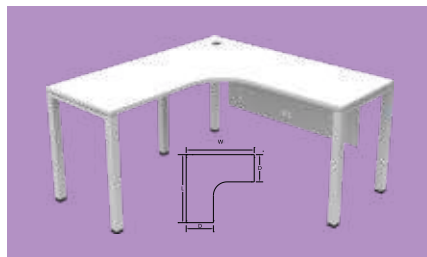

L-SHAPE TABLE

OF-NV-LS15 **RM 748**

W1500*D600*L1500*D600*H750 MM

OF-NV-LS18 **RM 798**

W1800*D600*L1800*D600*H750 MM



EXECUTIVE L-SHAPE TABLE

OF-NV-LS15FP **RM 788**

W1500*D600*L1500*D600*H750 MM

*Fixed Pedestal : W393*D461*H725 MM

OF-NV-LS18FP **RM 878**

W1800*D600*L1800*D600*H750 MM

*Fixed Pedestal : W393*D461*H725 MM

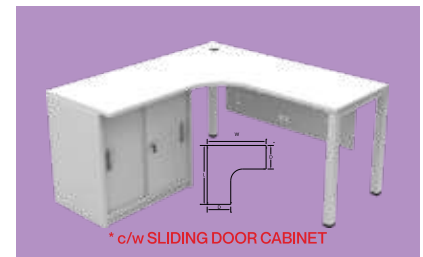

EXECUTIVE L-SHAPE TABLE

OF-NV-LS15FC **RM 818**

W1500*D600*L1500*D600*H750 MM

*Fixed Sliding Door Cabinet : W746*D390*H725 MM

OF-NV-LS18FC **RM 918**

W1800*D600*L1800*D600*H750 MM

*Fixed Sliding Door Cabinet : W746*D390*H725 MM

SNOW

SERIES

WHITE



Technical Specification

TOP SURFACE : 25mm thk melamine laminated chipboard in WHITE colour
TABLE LEG : 16mm thk melamine laminated chipboard in WHITE colour
MODESTY : 16mm thk melamine laminated chipboard in WHITE colour
EDGING : 2mm thk PVC in WHITE colour for top surface

Colour Option

Top Colour :



WHITE



LIGHT GREY

Base :



WHITE



LIGHT GREY

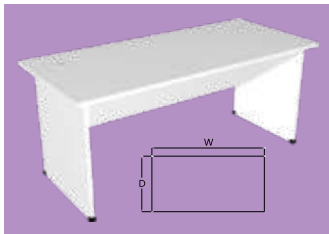

WRITING TABLE

OF-SN-127

W1200*D700*H750 MM

RM 225

OF-SN-157

W1500*D700*H750 MM

RM 255

OF-SN-187

W1800*D700*H750 MM

RM 315



WRITING TABLE
c/w HANGING 3D

OF-SN-127 (H3)

W1200*D700*H750 MM

RM 340

OF-SN-157 (H3)

W1500*D700*H750 MM

RM 380

OF-SN-187 (H3)

W1800*D700*H750 MM

RM 445



D-SHAPE EXECUTIVE
TABLE

OF-SN-1890

W1800*D900*H750 MM

RM 370

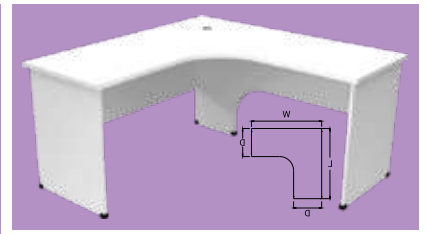

L-SHAPE TABLE
c/w CHIPBOARD LEG

OF-SN-L1515 (L/R)

W1500*D600*L1500
*D600*H750 MM

RM 400

OF-SN-L1818 (L/R)

W1800*D600*L1800
*D600*H750 MM

RM 470



SIDE TABLE

OF-SN-90

W900*D450*H750 MM

RM 195

OF-SN-105

W1050*D450*H750 MM

RM 205



OVAL CONFERENCE
TABLE

OF-SN-06

W1800*D900*H750 MM

RM 400

OF-SN-08

W2400*D1200*H750 MM

RM 570



ROUND DISCUSSION
TABLE

OF-SN-D3

Ø900*H750 MM

RM 275

OF-SN-D4

Ø1200*H750 MM

RM 320



RECTANGULAR
CONFERENCE TABLE

OF-SN-R6

W1800*D900*H750 MM

RM 400

OF-SN-R8

W2400*D1200*H750 MM

RM 570

MOBILE PEDESTAL



2 DRAWERS

OF-NL-M2D
W410*D485*H562

RM 215



3 DRAWERS

OF-NL-M3D
W410*D485*H562

RM 205



HIGH 3 DRAWERS

OF-NL-H3D
W410*D485*H640

RM 240



4 DRAWERS

OF-NL-M4D
W410*D485*H640

RM 250

STAND PEDESTAL



3 DRAWERS

OF-NL-S3D
W410*D485*H750

RM 260



4 DRAWERS

OF-NL-S4D
W410*D485*H750

RM 260

635/750/900/906 HEIGHT CABINET / * FOR 750 HEIGHT CABINET BODY (D) 390MM



SIDE CABINET

OF-NL-63-D2
W1050*D450*H635

RM 260



PIGEON HOLES CABINET

OF-NL-906-12P
W800*D410*H906

RM 270



OPEN SHELF CABINET

OF-NL-75-O
W750*D450*H750

RM 238

OF-NL-90-O
W900*D450*H900

RM 318

OF-NL-906-O
W800*D410*H906

RM 215



SWINGING DOOR CABINET

OF-NL-75-D1
W750*D450*H750

RM 308

OF-NL-90-D1
W900*D450*H900

RM 328

OF-NL-906-D1
W800*D410*H906

RM 265



SLIDING DOOR CABINET

OF-NL-75-D2
W750*D450*H750

RM 308

OF-NL-90-D2
W900*D450*H900

RM 328

OF-NL-906-D2
W800*D410*H906

RM 265

1200 / 1726 / 2100 HEIGHT CABINET
3 LEVELS / 4 LEVELS / 5 LEVELS



SLIDING DOOR CABINET

OF-NL-120-D2
W900*D450*H1200

RM 398



OPEN SHELF CABINET

OF-NL-120-O
W900*D450*H1200

RM 388

OF-NL-172-O
W800*D410*H1726

RM 368

OF-NL-210-O
W800*D410*H2100

RM 418



SWINGING DOOR CABINET

OF-NL-120-D1
W900*D450*H1200

RM 398

OF-NL-172-D1
W800*D410*H1726

RM 518

OF-NL-210-D1
W800*D410*H2100

RM 618



BOOK SHELF CABINET

OF-NL-172-G1
(WITH GLASS)
W800*D410*H1726

RM 518

COMBI STORAGE



PEDESTAL + SWINGING DOOR CABINET

OF-NL-12AE
W1300*D450*H750

RM 598



PEDESTAL + SLIDING DOOR CABINET

OF-NL-12BE
W1300*D450*H750

RM 598



PEDESTAL + OPEN SHELF CABINET

OF-NL-12CE
W1300*D450*H750

RM 518



OPEN SHELF + OPEN SHELF CABINET

OF-NL-15M-CC
W1500*D450*H750

RM 438

OF-NL-18M-CC
W1800*D450*H750

RM 508



SWING DOOR + SWING DOOR CABINET

OF-NL-15M-AA
W1500*D450*H750

RM 588

OF-NL-18M-AA
W1800*D450*H750

RM 648



SWING DOOR + SLIDING DOOR CABINET

OF-NL-15M-AB
W1500*D450*H750

RM 588

OF-NL-18M-AB
W1800*D450*H750

RM 648



SWING DOOR + OPEN SHELF CABINET

OF-NL-15M-AC
W1500*D450*H750

RM 508

OF-NL-18M-AC
W1800*D450*H750

RM 558



SLIDING DOOR + SLIDING DOOR CABINET

OF-NL-15M-BB
W1500*D450*H750

RM 588

OF-NL-18M-BB
W1800*D450*H750

RM 648



SLIDING DOOR + OPEN SHELF CABINET

OF-NL-15M-BC
W1500*D450*H750

RM 508

OF-NL-18M-BC
W1800*D450*H750

RM 558

Body Colour



LIGHT GREY



WHITE

Door & Head Drawer



LIGHT GREY



WHITE

E A Z Y SERIES

MAPLE



Technical Specification

TOP SURFACE : 25mm thk melamine laminated chipboard in MAPLE colour
TABLE LEG : Steel leg in DARK GREY colour only
MODESTY : Steel
EDGING : 2mm thk PVC in MAPLE colour for top surface

Top Colour : LIGHT GREY
 MAPLE

Colour Option

Additional: CHERRY CAPPUCINO Base : BLACK
Charges Apply THUJA LIGHT

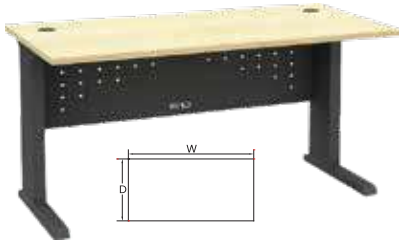

STRAIGHT MAIN TABLE

- OF-EZ-MT4** W1200*D750*H750 MM **RM 388**
- OF-EZ-MT5** W1500*D750*H750 MM **RM 428**
- OF-EZ-MT6** W1800*D750*H750 MM **RM 468**

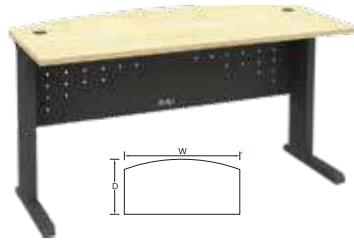

CURVE MAIN TABLE

- OF-EZ-MTC** **RM 538**
W1800*D900*H750 MM

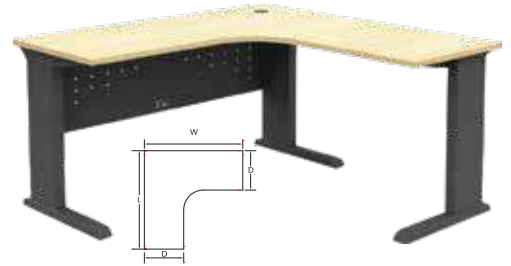

L-SHAPE TABLE

- OF-EZ-LS15** **RM 638**
W1500*D600*L1500*D600*H750 MM
- OF-EZ-LS18** **RM 718**
W1800*D600*L1800*D600*H750 MM

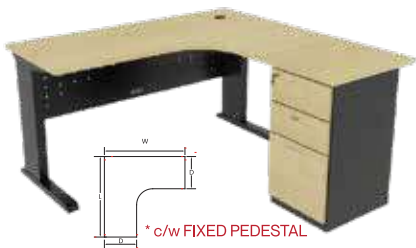

EXECUTIVE L-SHAPE TABLE

- OF-EZ-LS15FP** **RM 748**
W1500*D600*L1500*D600*H750 MM
*Fixed Pedestal : W393*D461*H725 MM
- OF-EZ-LS18FP** **RM 808**
W1800*D600*L1800*D600*H750 MM
*Fixed Pedestal : W393*D461*H725 MM

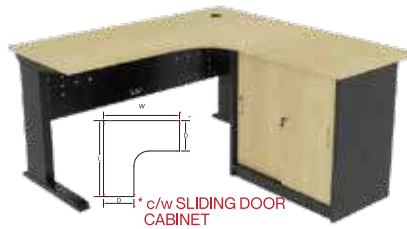

EXECUTIVE L-SHAPE TABLE

- OF-EZ-LS15FC** **RM 768**
W1500*D600*L1500*D600*H750 MM
*Fixed Sliding Door Cabinet : W746*D390*H725 MM
- OF-EZ-LS18FC** **RM 868**
W1800*D600*L1800*D600*H750 MM
*Fixed Sliding Door Cabinet : W746*D390*H725 MM



MONARCH CONCEPT

- OF-C2-MONARCH 12** **RM 1,218**
W1200*D1500*H750/1050 MM
- OF-C2-MONARCH 15** **RM 1,318**
W1500*D1500*H750/1050 MM
- OF-C2-MONARCH 18** **RM 1,418**
W1800*D1500*H750/1050 MM

F S M A P L E

SERIES

MAPLE
DARK GREY



Technical Specification

TOP SURFACE : 25mm thk melamine laminated chipboard in MAPLE colour
TABLE LEG : 16mm thk melamine laminated chipboard in DARK GREY colour
MODESTY : 16mm thk melamine laminated chipboard in DARK GREY colour
EDGING : 2mm thk PVC in MAPLE colour for top surface

Colour Option

Top Colour :  MAPLE | Base :  DARK GREY

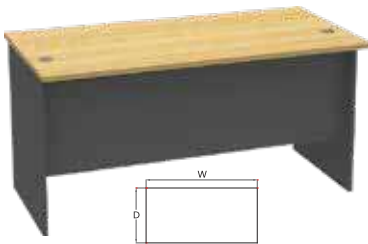

SIDE TABLE
(w/o GROMMET HOLE)

OF-FS-105 (M) W1050*D450*H750 MM **RM 190**

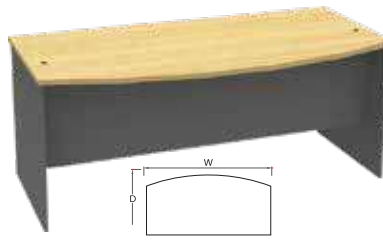

STANDARD CURVE TABLE

OF-FS-D1890 (M) **RM 355**
W1800*D900*H750 MM

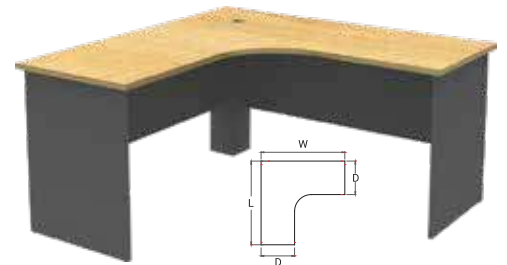

ERGONOMIC TABLE

OF-FS-L1515 (M) **RM 435**
W1500*D600*L1500*D600*H750 MM

STANDARD TABLE

OF-FS-1274 (M) W1200*D740*H750 MM **RM 210**

OF-FS-1574 (M) W1500*D740*H750 MM **RM 225**

OF-FS-1874 (M) W1800*D740*H750 MM **RM 285**

OF-FS-L1818 (M) **RM 558**
W1800*D600*L1800*D600*H750 MM



BAR TABLE

OF-FS-BT1260 (M) **RM 450**

W1200*D600*H1050 MM

OF-FS-BT1560 (M) **RM 550**

W1500*D600*H1050 MM

OF-FS-BT1860 (M) **RM 720**

W1800*D600*H1050 MM



DOUBLE BENCH TABLE

OF-FS-DB-1212 (M) **RM 535**

W1200*D1200*H750 MM

OF-FS-DB-1512 (M) **RM 655**

W1500*D1200*H750 MM

OF-FS-DB-1812 (M) **RM 770**

W1800*D1200*H750 MM



OVAL CONFERENCE TABLE

OF-FS-O6 (M) **RM 380**

W1800*D900*H750 MM

OF-FS-O8 (M) **RM 480**

W2400*D1200*H750 MM



ROUND DISCUSSION TABLE

OF-FS-D3 (M) **RM 255**

Ø900*H750 MM

OF-FS-D4 (M) **RM 305**

Ø1200*H750 MM

MOBILE PEDESTAL STAND PEDESTAL HANGING PEDESTAL FIXED PEDESTAL

2 DRAWERS	3 DRAWERS	HIGH 3 DRAWERS	4 DRAWERS	HIGH 3 DRAWERS	4 DRAWERS	2 DRAWERS	3 DRAWERS	HIGH 3 DRAWERS	4 DRAWERS
OF-FS-M2D(M) W410*D485*H562	OF-FS-M3D(M) W410*D485*H562	OF-FS-H3D(M) W410*D485*H640	OF-FS-M4D(M) W410*D485*H640	OF-FS-S3D(M) W410*D485*H750	OF-FS-S4D(M) W410*D485*H750	OF-FS-H2(M) W393*D446*H481	OF-FS-H3(M) W393*D446*H481	OF-FS-F2D+1F(M) W393*D446*H725	OF-FS-F4D(M) W393*D446*H725
RM 215	RM 205	RM 240	RM 240	RM 260	RM 260	RM 175	RM 165	RM 240	RM 240

635/750/820 HEIGHT CABINET / * FOR 750 HEIGHT CABINET BODY (D) 390MM

SIDE CABINET	PIGEON HOLES CABINET	OPEN SHELF CABINET	OPEN SHELF CABINET	SWINGING DOOR CABINET	SWINGING DOOR CABINET	SLIDING DOOR CABINET	SLIDING DOOR CABINET
OF-FS-SC(M) W1050*D450*H635	OF-FS-PG(M) W800*D450*H820	OF-FS-75-O(M) W750*D450*H750	OF-FS-OS(M) W800*D450*H820	OF-FS-75-D1(M) W750*D450*H750	OF-FS-SW(M) W800*D450*H820	OF-FS-75-D2(M) W750*D450*H750	OF-FS-SD(M) W800*D450*H820
RM 255	RM 250	RM 238	RM 195	RM 308	RM 250	RM 308	RM 250

1300 / 1640 / 2100 HEIGHT CABINET
3 LEVELS / 4 LEVELS / 5 LEVELS

SLIDING DOOR CABINET	OPEN SHELF CABINET	OPEN SHELF CABINET	OPEN SHELF CABINET	SWINGING DOOR CABINET	SWINGING DOOR CABINET	SWINGING DOOR CABINET	BOOK SHELF CABINET	BOOK SHELF CABINET	BOOK SHELF CABINET
OF-FS-130-D2(M) W900*D450*H1300	OF-FS-130-O(M) W900*D450*H1300	OF-FS-HOS(M) W800*D450*H1640	OF-FS-210-O(M) W900*D450*H2100	OF-FS-130-D1(M) W900*D450*H1300	OF-FS-WR(M) W800*D450*H1640	OF-FS-210-D1(M) W900*D450*H2100	OF-FS-CUP(M) (WITHOUT GLASS) W800*D450*H1640	OF-FS-SG(M) (WITH GLASS) W800*D450*H1640	OF-FS-210-G1(M) (WITH GLASS) W900*D450*H2100
RM 448	RM 338	RM 358	RM 448	RM 448	RM 495	RM 618	RM 458	RM 598	RM 738

COMBI STORAGE

PEDESTAL + SWINGING DOOR CABINET	PEDESTAL + SLIDING DOOR CABINET	PEDESTAL + OPEN SHELF CABINET	SLIDING DOOR + CPU STORAGE CABINET	OPEN SHELF + OPEN SHELF CABINET	OPEN SHELF + OPEN SHELF CABINET
OF-FS-12AE(M) W1300*D450*H750	OF-FS-12BE(M) W1300*D450*H750	OF-FS-12CE(M) W1300*D450*H750	OF-FS-12BF(M) W1200*D500*H750	OF-FS-15M-CC(M) W1500*D450*H750	OF-FS-18M-CC(M) W1800*D450*H750
RM 598	RM 598	RM 518	RM 358	RM 438	RM 508
SWING DOOR + SWING DOOR CABINET	SWING DOOR + SLIDING DOOR CABINET	SWING DOOR + OPEN SHELF CABINET	SLIDING DOOR + SLIDING DOOR CABINET	SLIDING DOOR + OPEN SHELF CABINET	SLIDING DOOR + OPEN SHELF CABINET
OF-FS-15M-AA(M) W1500*D450*H750	OF-FS-18M-AA(M) W1800*D450*H750	OF-FS-15M-AB(M) W1500*D450*H750	OF-FS-18M-AB(M) W1800*D450*H750	OF-FS-15M-AC(M) W1500*D450*H750	OF-FS-18M-AC(M) W1800*D450*H750
RM 588	RM 648	RM 588	RM 648	RM 508	RM 558
OF-FS-15M-BB(M) W1500*D450*H750	OF-FS-18M-BB(M) W1800*D450*H750	OF-FS-15M-BC(M) W1500*D450*H750	OF-FS-18M-BC(M) W1800*D450*H750	OF-FS-15M-CC(M) W1500*D450*H750	OF-FS-18M-CC(M) W1800*D450*H750
RM 588	RM 648	RM 508	RM 558	RM 508	RM 558

Colour Option MAPLE BodySurface DARK GREY

Z I V A SERIES



Technical Specification

TOP SURFACE : 25mm thk melamine laminated chipboard in ENGLAND OAK colour
TABLE LEG : 25mm PU paper in GREY SOLAMA
MODESTY : 18mm PU paper in GREY SOLAMA
EDGING : 2mm thk PVC in ENGLAND OAK colour for top surface

Colour Option

Top Colour : ENGLAND OAK **Base :** GREY SOLAMA



**EXECUTIVE
DESK**

OF-ZV-D1880
L1800*W800*H750 MM
RM 355



**EXECUTIVE
DESK**

OF-ZV-1270 L1200*W700*H750 MM **RM 210**
OF-ZV-1570 L1500*W700*H750 MM **RM 230**
OF-ZV-1870 L1800*W700*H750 MM **RM 275**



**SIDE
TABLE**

OF-ZV-SR1060
L1000*W600*H750 MM
RM 190



**UNIVERSAL
WORKSTATION**

OF-ZV-L1515
L1500*W600*H1500/600*H750 MM
RM 435



**BOAT SHAPED
CONFERENCE TABLE**
(c/w FLIPPER CASING ONLY)

OF-ZV-BSC 2412 **RM 668**
L2400*W1200*H750 MM



**BOAT SHAPED
CONFERENCE TABLE**
(c/w FLIPPER CASING ONLY)

OF-ZV-BSC 3612 **RM 1,288**
L3600*W1200*H750 MM



**ROUND
CONFERENCE
TABLE**

OF-ZV-RC900 **RM 255**
Ø900*H750 MM



**BOW FRONT
COUNTERISER**

OF-ZV-C12 **RM 175**
L1200*W350*H300 MM
OF-ZV-C15 **RM 195**
L1500*W350*H300 MM
OF-ZV-C18 **RM 205**
L1800*W350*H300 MM

*Images provided are for illustration purposes only. *Prices quoted are subject to change without prior notice & while stocks last.
 *Terms & conditions apply. *While every care is taken in the preparation of this flyer any inaccuracy or omission is much regretted.

M I Z A SERIES

SNOW
WHITE
NATURAL
OAK

Technical Specification

TOP SURFACE: 25mm thk melamine laminated chipboard in SNOW WHITE colour
TABLE LEG: 18mm thk PU paper in NATURA OAK colour
MODESTY: 18mm thk PU paper in NATURA OAK colour
EDGING: 2mm thk PVC in SNOW WHITE colour for top surface

Colour Option

Top Colour :  SNOW WHITE

Base :  NATURAL OAK



**EXECUTIVE
DESK**

OF-MZ-D1880
L1800*W800/700*H750 MM
RM 355



**STANDARD
DESK**

OF-MZ-1270 L1200*W700*H750 MM **RM 210**
OF-MZ-1570 L1500*W700*H750 MM **RM 230**
OF-MZ-1870 L1800*W700*H750 MM **RM 275**



**SIDE
TABLE**

OF-MZ-1060
L1000*W600*H750 MM
RM 190



**UNIVERSAL
WORKSTATION**

OF-MZ-L1515
L1500/600*W1500/600*H750 MM
RM 435



**SQUARE
MEETING
TABLE**

OF-MZ-SC900
Ø900*H750 MM
RM 255



**BOAT SHAPED
CONFERENCE TABLE**
(c/w FLIPPER CASING ONLY)

OF-MZ-BSC 2412 **RM 668**
L2400*W1200*H750 MM



**BOAT SHAPED
CONFERENCE TABLE**
(c/w FLIPPER CASING ONLY)

OF-MZ-BSC 3612 **RM 1,288**
L3600*W1200*H750 MM



**RECTANGULAR EXTENSION
CONFERENCE
TABLE**

OF-MZ-REC 1200 **RM 468**
L1200*W1200*H750 MM



**BOW FRONT
COUNTERISER**

OF-MZ-C12 **RM 175**
L1200*W350*H300 MM

OF-MZ-C15 **RM 195**
L1500*W350*H300 MM

OF-MZ-C18 **RM 205**
L1800*W350*H300 MM

ZIVA SERIES WOODEN STORAGE



PEDESTAL

750/1245 HEIGHT CABINET



MOBILE PEDESTAL (3D)
OF-ZV-MP3D
L415*W500*H560 mm
RM 205



HANGING PEDESTAL (3D)
OF-ZV-H3
L400*W500*H480 mm
RM 165



FIXED PEDESTAL
OF-ZV-FP-2D+1F
L400*W400*H725 mm
RM 240



SLIDING DOOR CABINET
OF-ZV-SL8075
L800*W400*H750 mm
RM 245



MEDIUM HEIGHT OPEN SHELF CABINET
OF-ZV-OS-80124
L800*W420*H1245 mm
RM 238



MEDIUM HEIGHT SWING DOOR CABINET WITH WOODEN DOOR
OF-ZV-SW-80124
L800*W420*H1245 mm
RM 308

2035 HEIGHT CABINET



BOOK SHELF WITH GLASS DOOR + SINGLE WOODEN DOOR CABINET (LEFT)
OF-ZV-BSGC 1220-L
L1200*W420*H2035 mm
RM 708



BOOK SHELF WITH GLASS DOOR + SINGLE WOODEN DOOR CABINET (RIGHT)
OF-ZV-BSGC 1220-R
L1200*W420*H2035 mm
RM 708



BOOK SHELF WITH GLASS DOOR
OF-ZV-BSGC 80203
L800*W420*H2035 mm
RM 518



BOOK SHELF WITH WOODEN DOOR
OF-ZV-SW 80203
L800*W420*H2035 mm
RM 518

Door & Head Drawer



ENGLAND OAK

Body Surface



GREY SOLAMA

MIZA SERIES WOODEN STORAGE

PEDESTAL

750 HEIGHT CABINET



HANGING PEDESTAL (3D)
OF-MZ-H3
L400*W500*H480 mm
RM 165



MOBILE PEDESTAL (3D)
OF-MZ-MP3D
L415*W500*H560 mm
RM 205



SLIDING DOOR CABINET
OF-MZ-SL8075
L800*W400*H750 mm
RM 248



OFIS STAND PEDESTAL + SLIDING DOOR CABINET
OF-MZ-SPSL-12075
L1200*W420*H750 mm
RM 498

1245/2035 HEIGHT CABINET



MEDIUM HEIGHT SWING DOOR CABINET
OF-MZ-SW-80124
L800*W420*H1245 mm
RM 308



BOOK SHELF WITH GLASS DOOR
OF-MZ-BSGC 80203
L800*W420*H2035 mm
RM 518



HIGH SWING DOOR CABINET
OF-MZ-SW 80203
L800*W420*H2035 mm
RM 518

Door & Head Drawer



SNOW WHITE

Body Surface



NATURAL OAK

FS GREY

SERIES

LIGHT GREY
DARK GREY



Technical Specification

TOP SURFACE: 25mm thk melamine laminated chipboard in **LIGHT GREY** colour
TABLE LEG: 16mm thk melamine laminated chipboard in **DARK GREY** colour
MODESTY: Wooden
EDGING: 2mm thk PVC in **LIGHT GREY** colour for top surface

Colour Option

Top Colour:  LIGHT GREY
Base:  DARK GREY

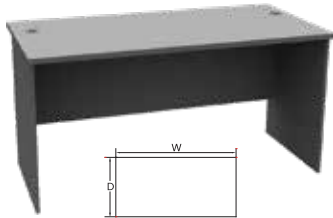

SIDE TABLE

(w/o GROMMET HOLE)

OF-FS-105 (G) W1050*D450*H750 MM **RM 175**

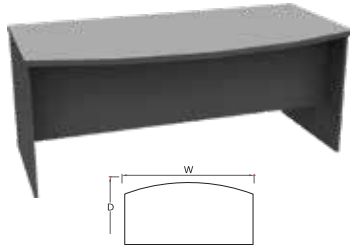

STANDARD CURVE TABLE

OF-FS-D1890 (G) **RM 345**
W1800*D900*H750 MM

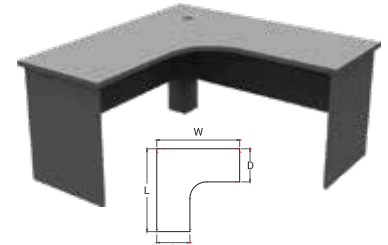

ERGONOMIC TABLE

OF-FS-L1515 (G) **RM 425**
W1500*D600*L1500*D600*H750 MM

OF-FS-L1818 (G) **RM 548**
W1800*D600*L1800*D600*H750 MM

STANDARD TABLE

OF-FS-1274 (G) W1200*D740*H750 MM **RM 195**

OF-FS-1574 (G) W1500*D740*H750 MM **RM 215**

OF-FS-1874 (G) W1800*D740*H750 MM **RM 260**



BAR TABLE

OF-FS-BT1260 (G) **RM 428**

W1200*D600*H1050 MM

OF-FS-BT1560 (G) **RM 510**

W1500*D600*H1050 MM

OF-FS-BT1860 (G) **RM 668**

W1800*D600*H1050 MM



DOUBLE BENCH TABLE

OF-FS-DB-1212 (G) **RM 470**

W1200*D1200*H750 MM

OF-FS-DB-1512 (G) **RM 570**

W1500*D1200*H750 MM

OF-FS-DB-1812 (G) **RM 670**

W1800*D1200*H750 MM



OVAL CONFERENCE TABLE

OF-FS-O6 (G) **RM 350**

W1800*D900*H750 MM

OF-FS-O8 (G) **RM 450**

W2400*D1200*H750 MM



ROUND DISCUSSION TABLE

OF-FS-D3 (G) **RM 245**

Ø900*H750 MM

OF-FS-D4 (G) **RM 295**

Ø1200*H750 MM

MOBILE PEDESTAL

STAND PEDESTAL

HANGING PEDESTAL

FIXED PEDESTAL

2 DRAWERS W410*D485*H562	3 DRAWERS W410*D485*H562	HIGH 3 DRAWERS W410*D485*H640	4 DRAWERS W410*D485*H640	HIGH 3 DRAWERS W410*D485*H750	4 DRAWERS W410*D485*H750	2 DRAWERS W393*D446*H487	3 DRAWERS W393*D446*H487	HIGH 3 DRAWERS W393*D446*H725	4 DRAWERS W393*D446*H725
OF-FS-M2D(G)	OF-FS-M3D(G)	OF-FS-H3D(G)	OF-FS-M4D(G)	OF-FS-S3D(G)	OF-FS-S4D(G)	OF-FS-H2(G)	OF-FS-H3(G)	OF-FS-F2D+1F(G)	OF-FS-F4D(G)
RM 185	RM 175	RM 210	RM 215	RM 235	RM 235	RM 165	RM 155	RM 215	RM 215

635/750/820 HEIGHT CABINET / *FOR 750 HEIGHT CABINET BODY (D) 390MM

SIDE CABINET W1050*D450*H635	PIGEON HOLES CABINET W800*D450*H820	OPEN SHELF CABINET W750*D450*H750	OPEN SHELF CABINET W800*D450*H820	SWINGING DOOR CABINET W750*D450*H750	SWINGING DOOR CABINET W800*D450*H820	SLIDING DOOR CABINET W750*D450*H750	SLIDING DOOR CABINET W800*D450*H820
OF-FS-SC(G)	OF-FS-PG(G)	OF-FS-75-O(G)	OF-FS-OS(G)	OF-FS-75-D1(G)	OF-FS-SW(G)	OF-FS-75-D2(G)	OF-FS-SD(G)
RM 240	RM 240	RM 218	RM 175	RM 278	RM 230	RM 278	RM 230

1300 / 1640 / 2100 HEIGHT CABINET (3 LEVELS / 4 LEVELS / 5 LEVELS)

SLIDING DOOR CABINET W900*D450*H1300	OPEN SHELF CABINET W900*D450*H1300	OPEN SHELF CABINET W800*D450*H1640	OPEN SHELF CABINET W900*D450*H2100	SWINGING DOOR CABINET W900*D450*H1300	SWINGING DOOR CABINET W800*D450*H1640	SWINGING DOOR CABINET W900*D450*H2100	BOOK SHELF CABINET (WITHOUT GLASS) W900*D450*H1640	BOOK SHELF CABINET (WITH GLASS) W800*D450*H1640	BOOK SHELF CABINET (WITH GLASS) W900*D450*H2100
OF-FS-130-D2(G)	OF-FS-130-O(G)	OF-FS-HOS(G)	OF-FS-210-O(G)	OF-FS-130-D1(G)	OF-FS-WR(G)	OF-FS-210-D1(G)	OF-FS-CUP(G)	OF-FS-SG(G)	OF-FS-210-G1(G)
RM 428	RM 328	RM 345	RM 448	RM 428	RM 435	RM 618	RM 385	RM 545	RM 738

COMBI STORAGE

PEDESTAL + SWINGING DOOR CABINET W1300*D450*H750	PEDESTAL + SLIDING DOOR CABINET W1300*D450*H750	PEDESTAL + OPEN SHELF CABINET W1300*D450*H750	SLIDING DOOR + CPU STORAGE CABINET W1200*D500*H750	OPEN SHELF + OPEN SHELF CABINET W1500*D450*H750	OPEN SHELF + OPEN SHELF CABINET W1800*D450*H750
OF-FS-12AE(G)	OF-FS-12BE(G)	OF-FS-12CE(G)	OF-FS-12BF(G)	OF-FS-15M-CC(G)	OF-FS-18M-CC(G)
RM 528	RM 538	RM 458	RM 328	RM 408	RM 488
SWING DOOR + SWING DOOR CABINET W1500*D450*H750	SWING DOOR + SWING DOOR CABINET W1800*D450*H750	SWING DOOR + SLIDING DOOR CABINET W1500*D450*H750	SWING DOOR + SLIDING DOOR CABINET W1800*D450*H750	SWING DOOR + OPEN SHELF CABINET W1500*D450*H750	SWING DOOR + OPEN SHELF CABINET W1800*D450*H750
OF-FS-15M-AA(G)	OF-FS-18M-AA(G)	OF-FS-15M-AB(G)	OF-FS-18M-AB(G)	OF-FS-15M-AC(G)	OF-FS-18M-AC(G)
RM 528	RM 578	RM 528	RM 578	RM 448	RM 498
SLIDING DOOR + SLIDING DOOR CABINET W1500*D450*H750	SLIDING DOOR + SLIDING DOOR CABINET W1800*D450*H750	SLIDING DOOR + OPEN SHELF CABINET W1500*D450*H750	SLIDING DOOR + OPEN SHELF CABINET W1800*D450*H750	SLIDING DOOR + CPU STORAGE CABINET W1500*D450*H750	SLIDING DOOR + CPU STORAGE CABINET W1800*D450*H750
OF-FS-15M-BB(G)	OF-FS-18M-BB(G)	OF-FS-15M-BC(G)	OF-FS-18M-BC(G)	OF-FS-15M-CC(G)	OF-FS-18M-CC(G)
RM 528	RM 578	RM 448	RM 498	RM 408	RM 488

Body Surface



Colour Option



FS TL HI UG JH AT SERIES

THUJA LIGHT
DARK GREY



Technical Specification

TOP SURFACE: 25mm thk melamine laminated chipboard in **THUJA LIGHT** colour
TABLE LEG: 16mm thk melamine laminated chipboard in **DARK GREY** colour
MODESTY: 16mm thk melamine laminated chipboard in **DARK GREY** colour
EDGING: 2mm thk PVC in **THUJA LIGHT** colour for top surface

Colour Option

Top Colour : THUJA LIGHT, WALNUT, CAPPUCINO, COIMBAR, PORTUNA BLACK, CHERRY, BEECH
Base : DARK GREY

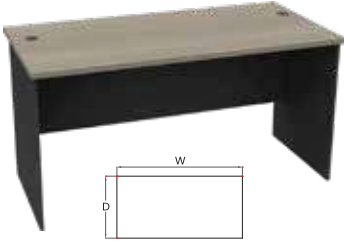

SIDE TABLE
(w/o GROMMET HOLE)

OF-FS-105 (TJ) W1050*D450*H750 MM **RM 228**

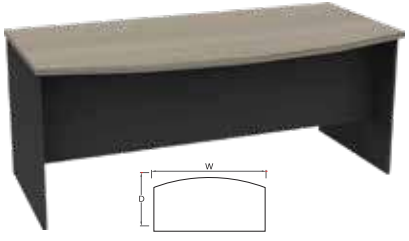

STANDARD CURVE TABLE

OF-FS-D1890 (TJ) **RM 458**
W1800*D900*H750 MM

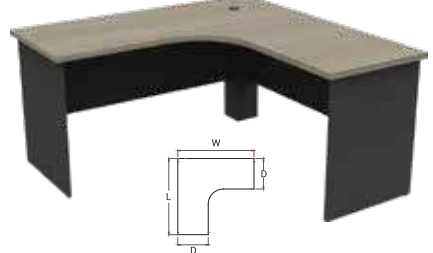

ERGONOMIC TABLE

OF-FS-L1515 (TJ) **RM 548**
W1500*D600*L1500*D600*H750 MM

OF-FS-L1818 (TJ) **RM 728**
W1800*D600*L1800*D600*H750 MM

STANDARD TABLE

- OF-FS-1274 (TJ)** W1200*D740*H750 MM **RM 265**
- OF-FS-1574 (TJ)** W1500*D740*H750 MM **RM 308**
- OF-FS-1874 (TJ)** W1800*D740*H750 MM **RM 398**



BAR TABLE

- OF-FS-BT1260 (TJ)** **RM 558**
W1200*D600*H1050 MM
- OF-FS-BT1560 (TJ)** **RM 650**
W1500*D600*H1050 MM
- OF-FS-BT1860 (TJ)** **RM 780**
W1800*D600*H1050 MM



DOUBLE BENCH TABLE

- OF-FS-DB-1212 (TJ)** **RM 605**
W1200*D1200*H750 MM
- OF-FS-DB-1512 (TJ)** **RM 740**
W1500*D1200*H750 MM
- OF-FS-DB-1812 (TJ)** **RM 875**
W1800*D1200*H750 MM



OVAL CONFERENCE TABLE

- OF-FS-O6 (TJ)** **RM 470**
W1800*D900*H750 MM
- OF-FS-O8 (TJ)** **RM 730**
W2400*D1200*H750 MM



ROUND DISCUSSION TABLE

- OF-FS-D3 (TJ)** **RM 300**
Ø900*H750 MM
- OF-FS-D4 (TJ)** **RM 420**
Ø1200*H750 MM

MOBILE PEDESTAL



2 DRAWERS
OF-FS-M2D(T/W/C)
W410*D485*H562

RM 248



3 DRAWERS
OF-FS-M3D(T/W/C)
W410*D485*H562

RM 238



HIGH 3 DRAWERS
OF-FS-H3D(T/W/C)
W410*D485*H640

RM 288



4 DRAWERS
OF-FS-M4D(T/W/C)
W410*D485*H640

RM 288

STAND PEDESTAL



HIGH 3 DRAWERS
OF-FS-S3D(T/W/C)
W410*D485*H750

RM 298



4 DRAWERS
OF-FS-S4D(T/W/C)
W410*D485*H750

RM 298

HANGING PEDESTAL



2 DRAWERS
OF-FS-H2(T/W/C)
W396*D446*H487

RM 190



3 DRAWERS
OF-FS-H3(T/W/C)
W396*D446*H487

RM 185

FIXED PEDESTAL



HIGH 3 DRAWERS
OF-FS-F2D+1F(T/W/C)
W393*D446*H725

RM 288



4 DRAWERS
OF-FS-F4D(T/W/C)
W393*D446*H725

RM 288

635/750/820 HEIGHT CABINET/*FOR 750 HEIGHT CABINET BODY (D) 390MM



SIDE CABINET
OF-FS-SC(T/W/C)
W1050*D450*H635

RM 330



PIGEON HOLES CABINET
OF-FS-PG(T/W/C)
W800*D450*H820

RM 310



OPEN SHELF CABINET
OF-FS-70-O(T/W/C) W750*D450*H750
OF-FS-0S(T/W/C) W800*D450*H820

RM 308

RM 230



SWINGING DOOR CABINET
OF-FS-75-D1(T/W/C) W750*D450*H750
OF-FS-SW(T/W/C) W800*D450*H820

RM 398

RM 305



SLIDING DOOR CABINET
OF-FS-75-D2(T/W/C) W750*D450*H750
OF-FS-SD(T/W/C) W800*D450*H820

RM 398

RM 305

1300 / 1640 / 2100 HEIGHT CABINET 3 LEVELS / 4 LEVELS / 5 LEVELS



SLIDING DOOR CABINET
OF-FS-130-D2(T/W/C)
W900*D450*H1300

RM 499



OPEN SHELF CABINET
OF-FS-130-O(T/W/C)
W900*D450*H1300

RM 388

OF-FS-HOS(T/W/C)
W800*D450*H1640

RM 358

OF-FS-210-O(T/W/C)
W900*D450*H2100

RM 488



SWINGING DOOR CABINET
OF-FS-130-D1(T/W/C)
W900*D450*H1300

RM 499

OF-FS-WR(T/W/C)
W800*D450*H1640

RM 618

OF-FS-210-D1(T/W/C)
W900*D450*H2100

RM 788



BOOK SHELF CABINET
OF-FS-CUP(T/W/C)
(WITHOUT GLASS)
W800*D450*H1640

RM 538

OF-FS-SG(T/W/C)
(WITH GLASS)
W800*D450*H1640

RM 698

OF-FS-210-G(T/W/C)
(WITH GLASS)
W900*D450*H2100

RM 888

COMBI STORAGE



PEDESTAL + SWINGING DOOR CABINET
OF-FS-12AE(T/W/C)
W1300*D450*H750

RM 808



PEDESTAL + SLIDING DOOR CABINET
OF-FS-12BE(T/W/C)
W1300*D450*H750

RM 798



PEDESTAL + OPEN SHELF CABINET
OF-FS-12CE(T/W/C)
W1300*D450*H750

RM 698



RIGHT
SLIDING DOOR + CPU STORAGE CABINET
OF-FS-12BF(T/W/C)
W1200*D500*H750

RM 548



LEFT
OPEN SHELF + OPEN SHELF CABINET
OF-FS-15M-CC(T/W/C) W1500*D450*H750
OF-FS-18M-CC(T/W/C) W1800*D450*H750

RM 678

RM 768



SWING DOOR + SWING DOOR CABINET
OF-FS-15M-AA(T/W/C) W1500*D450*H750
OF-FS-18M-AA(T/W/C) W1800*D450*H750

RM 818

RM 878



SWING DOOR + SLIDING DOOR CABINET
OF-FS-15M-AB(T/W/C) W1500*D450*H750
OF-FS-18M-AB(T/W/C) W1800*D450*H750

RM 818

RM 878



SWING DOOR + OPEN SHELF CABINET
OF-FS-15M-AC(T/W/C) W1500*D450*H750
OF-FS-18M-AC(T/W/C) W1800*D450*H750

RM 818

RM 878



SLIDING DOOR + SLIDING DOOR CABINET
OF-FS-15M-BB(T/W/C) W1500*D450*H750
OF-FS-18M-BB(T/W/C) W1800*D450*H750

RM 818

RM 878



SLIDING DOOR + OPEN SHELF CABINET
OF-FS-15M-BC(T/W/C) W1500*D450*H750
OF-FS-18M-BC(T/W/C) W1800*D450*H750

RM 818

RM 878

Body Surface



Colour Option



ZICO SERIES

SILK
WHITE OAK
KRONBERG



Technical Specification

TOP SURFACE : 25mm thk melamine laminated chipboard in SILK WHITE OAK colour
TABLE LEG : 38mm x 38mm SQUARE HOLLOW MILD STEEL
MODESTY : Wooden
EDGING : 2mm thk PVC in SILK WHITE OAK for top surface

Colour Option

Top Colour : SILK WHITE OAK
 AMBERG

Base : DARK GREY



EXECUTIVE TABLE WITH
SIDE CABINET (LEFT / RIGHT)

OF-ZICO-01L/R

W2200*D950*H1780/D600*H750 MM

RM 1,988



RECTANGULAR CONFERENCE
TABLE

OF-ZO-RCT2412 W2400*D1200*H750 MM

RM 1,298

OF-ZO-RCT3012 W3000*D1200*H750 MM

RM 1,588

OF-ZO-RCT3612 W3600*D1200*H750 MM

RM 1,688



STANDARD DESK

OF-ZO-1880

W1800*D800*H750 MM

RM 698



STANDARD DESK

OF-ZO-1260
W1200*D600*H750 MM

RM 498

OF-ZO-1460
W1400*D600*H750 MM

RM 558

OF-ZO-1560
W1500*D600*H750 MM

RM 578

OF-ZO-1660
W1600*D600*H750 MM

RM 588

OF-ZO-1860
W1800*D600*H750 MM

RM 608

OF-ZO-1270
W1200*D700*H750 MM

RM 538

OF-ZO-1470
W1400*D700*H750 MM

RM 598

OF-ZO-1570
W1500*D700*H750 MM

RM 628

OF-ZO-1670
W1600*D700*H750 MM

RM 638

OF-ZO-1870
W1800*D700*H750 MM

RM 668



STANDARD HIGH
DESK

OF-ZO-1270-H
W1200*D700*H1040 MM

RM 898

OF-ZO-1570-H
W1500*D700*H1040 MM

RM 998

OF-ZO-1570-H
W1500*D700*H1040 MM

RM 1,058



SQUARE MEETING
TABLE

OF-ZO-100
W1000*D1000*H750 MM

RM 508



SQUARE HIGH
MEETING TABLE

OF-ZO-100-H
W1000*D1000*H1040 MM

RM 548



RECEPTION COUNTER

OF-ZO-RC16 W1643*D330*H1135 MM

RM 898

OF-ZO-RC18 W1843*D330*H1135 MM

RM 908



HUTCH WITH WOODEN DOOR

OF-ZO-H150 W1500*D360*H900 MM

RM 568

OF-ZO-H160 W1600*D360*H900 MM

RM 578

OF-ZO-H180 W1800*D360*H900 MM

RM 598



RECTANGULAR EXTENSION
CONFERENCE TABLE

OF-ZO-REC1212
W1200*D1200*H750 MM

RM 648



WOODEN MODESTY PANEL

OF-ZO-MP1100
W1100*D370*H18 MM

RM 100

OF-ZO-MP1300
W1300*D370*H18 MM

RM 110

OF-ZO-MP1400
W1400*D370*H18 MM

RM 120

OF-ZO-MP1500
W1500*D370*H18 MM

RM 130

OF-ZO-MP1700
W1700*D370*H18 MM

RM 140

MORO SERIES



COLOMBIA WALNUT
LIVORNO BEECH



Technical Specification

TOP SURFACE : 25mm thk melamine laminated chipboard in COLOMBIA WALNUT colour
TABLE LEG : Wooden in LIVORNO BEECH
MODESTY : Wooden in COLOMBIA WALNUT colour
EDGING : 2mm thk PVC in COLOMBIA WALNUT colour for top surface

Colour Option

Top Colour :  COLOMBIA WALNUT | Base :  LIVORNO BEECH



MORO EXECUTIVE TABLE WITH SIDE CABINET (LEFT) / (RIGHT)
OF-MORO-01
 Table : W2100*D900*W1700*D600*H750 MM
RM 1,888



BOAT SHAPE CONFERENCE TABLE (c/w FLIPPER CASING ONLY)
OF-MO-BS4812
 W4800*D1200*H750 MM
RM 2,488



BOAT SHAPE CONFERENCE TABLE (c/w FLIPPER CASING ONLY)
OF-MO-BS3612
 W3600*D1200*H750 MM
RM 1,668



BOAT SHAPE CONFERENCE TABLE (c/w FLIPPER CASING ONLY)
OF-MO-BS2412
 W2400*D1200*H750 MM
RM 1,088



RECTANGULAR EXTENSION CONFERENCE TABLE (c/w FLIPPER CASING ONLY)
OF-MO-REC1200
 W1200*D1200*H750 MM
RM 768



STANDARD DESK WITH FLIP COVER
OF-MO-1275 W1200*D750*H750 MM **RM 538**
OF-MO-1475 W1400*D750*H750 MM **RM 598**
OF-MO-1575 W1500*D750*H750 MM **RM 608**
OF-MO-1675 W1600*D750*H750 MM **RM 618**
OF-MO-1875 W1800*D750*H750 MM **RM 648**



SHARING DESK WITH FLIP COVER
OF-MO-1414 W1400*D1400*H750 MM **RM 908**
OF-MO-1514 W1500*D1400*H750 MM **RM 928**
OF-MO-1614 W1600*D1400*H750 MM **RM 948**
OF-MO-1814 W1800*D1400*H750 MM **RM 978**



RECEPTION COUNTER
OF-MO-RC16 W1640*D450*H1135 MM **RM 1,038**
OF-MO-RC18 W1840*D450*H1135 MM **RM 1,088**



RECEPTION COUNTER SIDE RETURN
OF-MO-RCR14
 W1380*D600*H1135 MM
RM 488



ROUND MEETING TABLE
OF-MO-R100
 Ø1000*H750 MM
RM 528



WOODEN MODESTY PANEL
OF-MO-MP680 **RM 100**
 W680*D370*T18 MM
OF-MO-MP880 **RM 110**
 W880*D370*T18 MM
OF-MO-MP980 **RM 120**
 W980*D370*T18 MM
OF-MO-MP1080 **RM 130**
 W1080*D370*T18 MM
OF-MO-MP1280 **RM 140**
 W1280*D370*T18 MM

*Images provided are for illustration purposes only. *Prices quoted are subject to change without prior notice & while stocks last.
 *Terms & conditions apply. *While every care is taken in the preparation of this flyer any inaccuracy or omission is much regretted.



2DIF MOBILE PEDESTAL

OF-ZO-M2D+1F
W400*D470*H650 MM

RM 445



FIXED PEDESTAL (2D1F) WITH METAL LEG BASE

OF-ZO-FP-2D+1F
W400*D700*H725 MM

RM 598



FIXED PEDESTAL TOP FOR MX2

OF-ZO-FPT
W400*D700*T25 MM

RM 80



OPEN BOX (LEFT/RIGHT) FOR FIXED PEDESTAL

OF-ZO-OB
W400*D700*H315 MM

RM 200



2 DRAWER LATERAL FILE WITH METAL LEG BASE

OF-ZO-LF2D
W800*D600*H750 MM

RM 798



LOW SLIDING DOOR CABINET WITH METAL LEG BASE

OF-ZO-SL8075
W800*D420*H750 MM

RM 478



LOW SWINGING DOOR CABINET WITH METAL LEG BASE

OF-ZO-SW8075
W800*D420*H750 MM

RM 508



STAND PEDESTAL + SLIDING DOOR CABINET

OF-ZO-SPSL-1275
W1200*D420*H750 MM

RM 898



DUAL SINGLE SWING DOOR + OPEN SHELF CABINET

OF-ZO-2SWOS-1275 W1200*D420*H750 MM

RM 658

OF-ZO-2SWOS-1475 W1400*D420*H750 MM

RM 698

OF-ZO-2SWOS-1675 W1600*D420*H750 MM

RM 798

OF-ZO-2SWOS-1875 W1800*D420*H750 MM

RM 828



SINGLE MEDIUM HEIGHT CABINET WITH METAL LEG BASE

OF-ZO-SSW40128
W400*D720*700*H1280 MM

RM 598



MEDIUM HEIGHT CABINET WITH WOODEN DOOR & METAL LEG BASE

OF-ZO-SW80148
W800*D420*H1485 MM

RM 868



HEIGHT CABINET WITH WOODEN DOOR & METAL LEG BASE

OF-ZO-SSW40128
W800*D420*H1865 MM

RM 918



SIDE PIER 4 TIERS

OF-ZO-SP4
W760*D400*H1485 MM

RM 428



SIDE PIER 5 TIERS

OF-ZO-SP5
W760*D400*H1865 MM

RM 528

Body Colour



KRONBERG



AMBERG GREY

Door & Head Drawer



SLIK WHITE OAK



AMBERG



MOBILE PEDESTAL (1D1F)

OF-MO-M2D
W400*D475*H510 MM

RM 318



2DIF MOBILE PEDESTAL

OF-MO-M2D+1F
W400*D475*H650 MM

RM 398



SIDE CABINET FOR SHARING DESK

OF-MO-SC1475
W1400*D445*H750 MM

RM 928



SIDE CABINET C/W 2D + 1F

OF-MO-SC1475
W1200*D450*H750 MM

RM 738



LOW OPEN SHELF CABINET

OF-MO-OS8075
W800*D450*H750 MM

RM 288



LOW SWINGING DOOR CABINET

OF-MO-SD8075
W800*D450*H750 MM

RM 358



LOW SLIDING DOOR CABINET

OF-MO-SL8075
W800*D450*H750 MM

RM 358



WOODEN DOOR FOR MO-OS80127

OF-MO-1275WD
W1144*L790/395*T18 MM

RM 228



HIGH CABINET WITH WOODEN DOOR

OF-MO-SW90168
W900*D450*H1680 MM

RM 808



MEDIUM HEIGHT CABINET WITH 1 OPEN SHELF + WOODEN DOOR CABINET

OF-MO-OSW1275
W800*D450*H1275 MM

RM 488



MEDIUM HEIGHT CABINET WITH LEFT/RIGHT SWING DOOR CABINET

OF-MO-SSW80127
W800*D450*H1275 MM

RM 528



MEDIUM HEIGHT OPEN SHELF CABINET

OF-MO-OS80127
W800*D450*H1275 MM

RM 388



HIGH OPEN CABINET

OF-MO-OS90168
W900*D450*H1680 MM

RM 548



SIDE PIER 4 TIER

OF-MO-SP1286
W600*D292*H1286 MM

RM 368



SIDE PIER 5 TIER

OF-MO-SW90168
W600*D292*H1677 MM

RM 438

Body Colour



LIVORNO BEECH

Door & Head Drawer



COLOMBIA WALNUT

HAWK II

SERIES

MAPLE

WHITE

Technical Specification

TOP SURFACE : 25mm thk melamine laminated chipboard in MAPLE colour
TABLE LEG : Steel leg in WHITE colour only
MODESTY : Wooden
EDGING : 2mm thk PVC in MAPLE colour for top surface

Colour Option

Top Colour :  CHERRY  MAPLE  TEAK
 BEECH  BLACK

Base :  WHITE

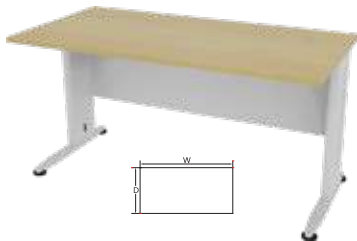

STRAIGHT MAIN TABLE

OF-HWII-MT4

W1200*D750*H750 MM

RM 388

OF-HWII-MT5

W1500*D750*H750 MM

RM 428

OF-HWII-MT6

W1800*D750*H750 MM

RM 468

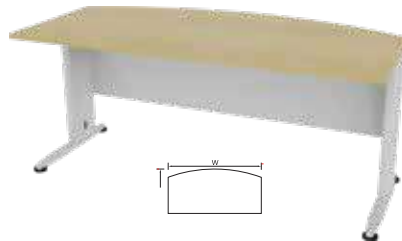

CURVE MAIN TABLE

OF-HWII-MTC

W1800*D900*H750 MM

RM 538

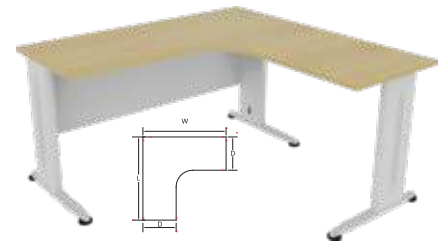

L-SHAPE TABLE

OF-HWII-LS15

W1500*D600*L1500*
D600*H750 MM

RM 638

OF-HWII-LS18

W1800*D600*L1800*
D600*H750 MM

RM 718

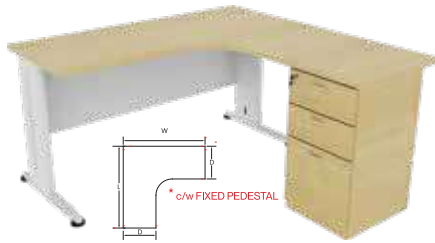

EXECUTIVE L-SHAPE TABLE

OF-HWII-LS15FP

W1500*D600*L1500*D600*H750 MM

*Fixed Pedestal : W396*D463*H725 MM

RM 748

OF-HWII-LS18FP

W1800*D600*L1800*D600*H750 MM

*Fixed Pedestal : W396*D463*H725 MM

RM 868

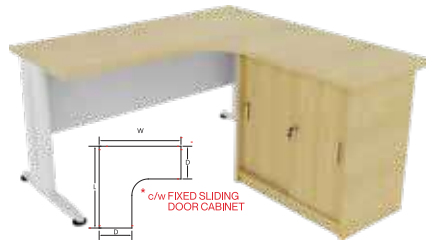

EXECUTIVE L-SHAPE TABLE

OF-HWII-LS15FC

W1500*D600*L1500*D600*H750 MM

*Fixed Sliding Door Cabinet : W746*D390*H725 MM

RM 828

OF-HWII-LS18FC

W1800*D600*L1800*D600*H750 MM

*Fixed Sliding Door Cabinet : W746*D390*H725 MM

RM 958



HAWK II CONCEPT

OF-C2-HAWK12

W1200*D1500*H750/1050 MM

RM 1,218

OF-C2-HAWK15

W1500*D1500*H750/1050 MM

RM 1,318

OF-C2-HAWK18

W1800*D1500*H750/1050 MM

RM 1,418

FO

SERIES

CHERRY



Technical Specification

TOP SURFACE: 25mm thk melamine laminated chipboard in **CHERRY** colour
TABLE LEG: 16mm thk melamine laminated chipboard in **CHERRY** colour
MODESTY: 16mm thk melamine laminated chipboard in **CHERRY** colour
EDGING: 2mm thk PVC in **CHERRY** colour for top surface

Colour Option

Top Colour : CHERRY MAPLE BEECH BLACK

Base : CHERRY MAPLE WHITE BLACK



WRITING TABLE

OF-FO-127

W1200*D700*H750 MM

RM 260

OF-FO-157

W1500*D700*H750 MM

RM 285

OF-FO-187

W1800*D700*H750 MM

RM 335



WRITING TABLE c/w HANGING 3D

OF-FO-127 (H3)

W1200*D700*H750 MM

RM 425

OF-FO-157 (H3)

W1500*D700*H750 MM

RM 465

OF-FO-187 (H3)

W1800*D700*H750 MM

RM 525

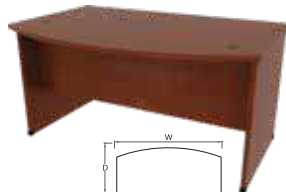

D-SHAPE EXECUTIVE TABLE

OF-FO-1890

W1800*D900*H750 MM

RM 390

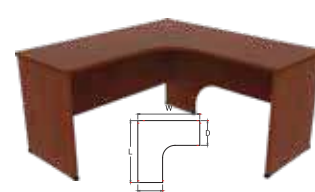

*(Right Side)

L-SHAPE TABLE c/w CHIPBOARD LEG

OF-FO-L1515 (L/R)

RM 488

W1500*D600*L1500
*D800*H750 MM

OF-FO-L1818 (L/R)

RM 499

W1800*D600*L1800
*D800*H750 MM



SIDE TABLE

OF-FO-900

W900*D450*H750 MM

RM 220

OF-FO-105

W1050*D450*H750 MM

RM 230



OVAL CONFERENCE TABLE

OF-FO-O6

W1800*D900*H750 MM

RM 438

OF-FO-O8

W2400*D1200*H750 MM

RM 608



ROUND DISCUSSION TABLE

OF-FO-D3

Ø900*H750 MM

RM 328

OF-FO-D4

Ø1200*H750 MM

RM 378



RECTANGULAR CONFERENCE TABLE

OF-FO-R6

W1800*D900*H750 MM

RM 438

OF-FO-R8

W2400*D1200*H750 MM

RM 608



FM SERIES



Technical Specification

TOP SURFACE : 25mm thk melamine laminated chipboard in **BEECH** colour
TABLE LEG : 16mm thk melamine laminated chipboard in **BEECH & WHITE** colour
MODESTY : 16mm thk melamine laminated chipboard in **WHITE** colour
EDGING : 2mm thk PVC in **BEECH** colour for top surface

Colour Option

Top Colour : CHERRY MAPLE BEECH **Base** : WHITE



WRITING TABLE

- FM-127** W1200*D700*H750 MM **RM 270**
- FM-157** W1500*D700*H750 MM **RM 290**
- FM-187** W1800*D700*H750 MM **RM 320**



WRITING TABLE

- FM-96** W900*D600*H750 MM **RM 240**
- FM-126** W1200*D600*H750 MM **RM 260**



SIDE RETURN TABLE

- FM-900** W900*D450*H630 MM **RM 210**
- FM-105** W1050*D450*H630 MM **RM 220**



ROUND DISCUSSION TABLE

- FM-D3** Ø900*H750 MM **RM 278**
- FM-D4** Ø1200*H750 MM **RM 358**



OVAL CONFERENCE TABLE

- FM-O6** W1800*D900*H750 MM **RM 408**
- FM-O8** W2400*D1200*H750 MM **RM 578**

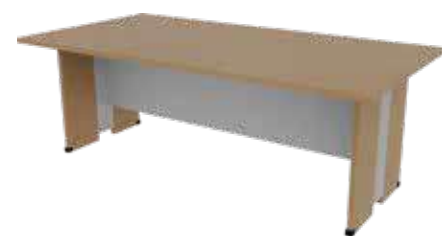

RECTANGULAR CONFERENCE TABLE

- FM-R6** W1800*D900*H750 MM **RM 408**
- FM-R8** W2400*D1200*H750 MM **RM 578**

MOBILE PEDESTAL

2 DRAWERS OF-FO-M2D W410*D485*H562	3 DRAWERS OF-FO-M3D W410*D485*H562	HIGH 3 DRAWERS OF-FO-H3D W410*D485*H640	4 DRAWERS OF-FO-M4D W410*D485*H640
RM 245	RM 235	RM 275	RM 275

STAND PEDESTAL

HIGH 3 DRAWERS OF-FO-S3D W410*D485*H750	4 DRAWERS OF-FO-S4D W410*D485*H750
RM 314	RM 314

HANGING PEDESTAL

2 DRAWERS OF-FO-H2 W393*D446*H487	3 DRAWERS OF-FO-H3 W393*D446*H487
RM 218	RM 208

FIXED PEDESTAL

HIGH 3 DRAWERS OF-FO-F2D+1F W393*D446*H725	4 DRAWERS OF-FO-F4D W393*D446*H725
RM 295	RM 295

635/750/820/900 HEIGHT CABINET / *FOR 750 HEIGHT CABINET BODY (D) 390MM

OF-FO-63-D2 W1050*D450*H635 RM 300	OF-FO-82-12P W800*D410*H820 RM 340	OF-FO-82-O W800*D410*H820 RM 250	OF-FO-75-D1 W750*D450*H750 RM 398	OF-FO-82-D1 W800*D410*H820 RM 330
		OF-FO-90-O W900*D450*H900 RM 408	OF-FO-75-D2 W750*D450*H750 RM 398	OF-FO-90-D1 W900*D450*H900 RM 418
			OF-FO-82-D2 W800*D410*H820 RM 330	OF-FO-90-D2 W900*D450*H900 RM 418

MOBILE CPU HOLDER

OF-FO-MC
W263*D454*H605
RM 170

HANGING CPU HOLDER

OF-FO-HC
W260*D450*H525
RM 160

MOBILE CPU HOLDER

OF-FO-SCPU
W270*D500*H225
RM 140

1200 / 1640 / 2014 HEIGHT CABINET / 3 LEVELS / 4 LEVELS / 5 LEVELS

OF-FO-120-D2 W900*D450*H1200 RM 548	OF-FO-164-G1 (WITH GLASS) W800*D410*H1640 RM 585	OF-FO-120-O W900*D450*H1200 RM 538	OF-FO-164-D1 W800*D410*H1640 RM 585
		OF-FO-201-O W800*D410*H2014 RM 535	OF-FO-201-D1 W800*D410*H2014 RM 685

COMBI STORAGE

OF-FO-12AE W1300*D450*H750 RM 788	OF-FO-12BE W1300*D450*H750 RM 768	OF-FO-12CE W1300*D450*H750 RM 678	OF-FO-12BF W1200*D500*H750 RM 428	OF-FO-15M-CC W1500*D450*H750 RM 658
				OF-FO-18M-CC W1800*D450*H750 RM 758
OF-FO-15M-AA W1500*D450*H750 RM 808	OF-FO-18M-AA W1800*D450*H750 RM 868	OF-FO-15M-AB W1500*D450*H750 RM 808	OF-FO-18M-AB W1800*D450*H750 RM 868	OF-FO-15M-AC W1500*D450*H750 RM 698
				OF-FO-18M-AC W1800*D450*H750 RM 768
			OF-FO-15M-BB W1500*D450*H750 RM 808	OF-FO-18M-BB W1800*D450*H750 RM 868
				OF-FO-15M-BC W1500*D450*H750 RM 698
				OF-FO-18M-BC W1800*D450*H750 RM 768

Colour Option



Body Surface





12PT

16PT



12PT

Size (W * D * H) : 1500 * 870 * 1165 (mm)

RM 2,088

16PT

Size (W * D * H) : 2400 * 870 * 1165 (mm)

RM 3,388

Colour Option

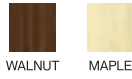

WALNUT MAPLE

RECEPTION COUNTER SERIES



Size (W * D * H) : 1800 * 620 * 1050 (mm)

RM 2,438

Colour Option

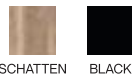

SCHATTEN BLACK



Size (W * D * H) : 1800 * 700 * 1050 (mm)

RM 2,668

Colour Option



CANYON BLACK

H
E
X
A



Size (W * D * H) : 2400 * 600 * 1100 (mm)

RM 2,888

Colour Option



RECEPTION COUNTER SERIES



S
H
A
P
L
E
Y



Size (W * D * H) : 2400 * 750 * 1165 (mm)

RM 4,168

Colour Option



L
E
O

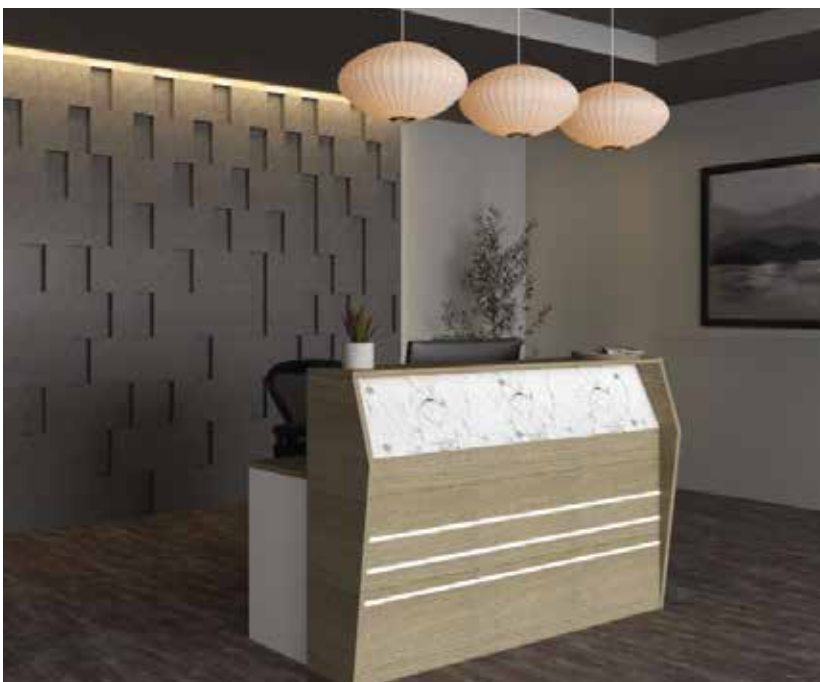

Size (W * D * H) : 1800 * 825 * 1165 (mm)

RM 2,588

Colour Option



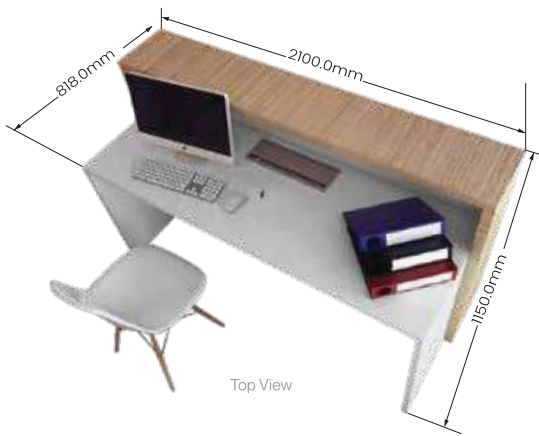

Top View

Size (W * D * H) : 2100 * 818 * 1150 (mm)

RM 3,088

Colour Option



S
I
M
P
L
I
C
I
T
Y



RECEPTION COUNTER SERIES



Back View

RC-LM01 (*Pedestal not included)

Size (W * D * H) : 3600 * 800 * 1050 (mm)

RM 4,558

Colour Option



E
L
E
G
A
N
T



Back View

RC-LM03

Size (W * D * H) : 2400 * 800 * 1050 (mm)

RM 5,988

Colour Option



J
A
Y

*Images provided are for illustration purposes only. *Prices quoted are subject to change without prior notice & while stocks last. *Terms & conditions apply. *While every care is taken in the preparation of this flyer any inaccuracy or omission is much regretted.

LESLEY



Size (W * D * H): 1800 * 910 * 1050 (mm)

RM 2,588

Colour Option

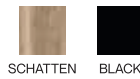

RECEPTION COUNTER SERIES



PHACELIA



Back View



Front View

PHACELIA-16 (*Chair not included)

Size (W * D * H): 1600 * 1077 * 1050 (mm)

RM 2,118

PHACELIA-19

Size (W * D * H): 1900 * 1077 * 1050 (mm)

RM 2,208

Colour Option



PISTIA



Back View



Front View

PISTIA-16 (*Chair not included)

Size (W * D * H): 1600 * 800 * 1200 (mm)

RM 888

PISTIA-19 (*Chair not included)

Size (W * D * H): 1900 * 800 * 1200 (mm)

RM 958

Colour Option





B - S C T

B-SCT 1500

Size (W * D * H) : 1538 * 404 * 1050 (mm) **RM 1,488**

B-SCT 1800

Size (W * D * H) : 1838 * 404 * 1050 (mm) **RM 1,788**

Colour Option



BORAS ASH

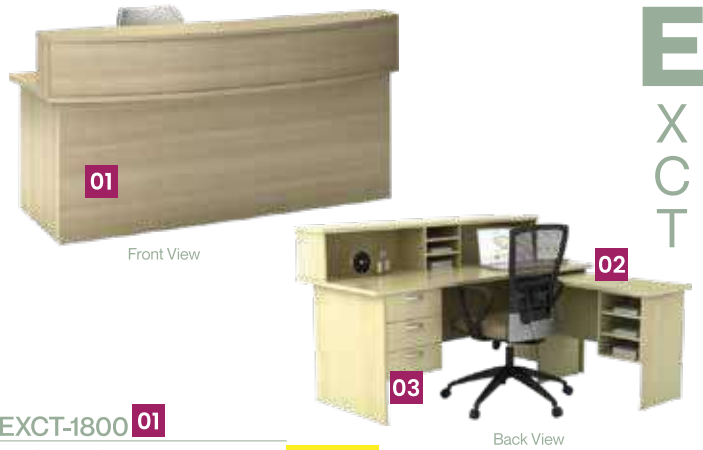

E X C T

EXCT-1800 01

Size (W * D * H) : 1800 * 900 * 1050 (mm) **RM 688**

EXS1060 02

Size (W * D * H) : 900 * 450 * 700 (mm) **RM 238**

Q-YH-3 03

Size (W * D * H) : 396 * 468 * 480 (mm) **RM 218**

Colour Option



MAPLE

ACACIA WALNUT

BORAS ASH



P A N I C U M

Size (W * D * H) : 1800 (700) * 1500 (700) * 1150 (mm) **RM 1,298**

Colour Option



MAPLE

WALNUT

BORAS ASH

RECEPTION COUNTER SERIES



E X C T - 1 7 1 5

Size (W * D * H) : 1750 (750) * 1500 (750) * 1150 (mm) **RM 1,248**

Colour Option



MAPLE

ACACIA WALNUT

BORAS ASH



P A S S I F L O R A

Size (W * D * H) : 2000 * 1675 * 1050 (mm) **RM 1,998**

Colour Option



Spex Collection FABRIC COLOUR

WHITE



P H A L A R I S

Size (W * D * H) : 3645 * 1675 * 1050 (mm) **RM 3,828**

Colour Option



Spex Collection FABRIC COLOUR

WHITE

• Images provided are for illustration purposes only. • Prices quoted are subject to change without prior notice & while stocks last. • Terms & conditions apply. • While every care is taken in the preparation of this flyer any inaccuracy or omission is much regretted.



GREATER FREEDOM TO CREATE

Create private manager workstation that welcome lights through glass panels while distances are reduced and communication is enhanced.

A wide variety of design options with each to support users' individual work styles.

It is a total compact office solution that promotes productivity and motivates performance.

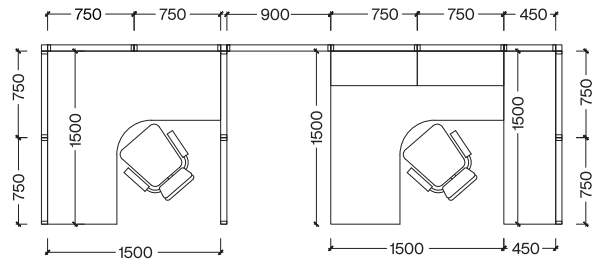

BLOCK SYSTEM PANEL (54 mm THK)

CALL FOR **BEST PRICE**

MODEL	DESCRIPTION	SPECIFICATION (mm)	QTY
OF-FBBW54-165 X 75	FULL BOARD PARTITION WITH BOTTOM TRUNKING	(H) 1650 * (W) 750	4
OF-FBBW54-165 X 45	FULL BOARD PARTITION WITH BOTTOM TRUNKING	(H) 1650 * (W) 450	1
OF-FBBW54-165 X 90	FULL BOARD PARTITION WITH BOTTOM TRUNKING	(H) 1650 * (W) 900	1
OF-HGBW54-165 X 75	HALF GLASS PARTITION WITH BOTTOM TRUNKING	(H) 1650 * (W) 750	2
OF-FBBW54-120 X 75	FULL BOARD PARTITION WITH BOTTOM TRUNKING	(H) 1200 * (W) 750	4
OF-TP54-165	TEE POLE	(H) 1650	1
OF-CP54-165	CORNER POLE	(H) 1650	1
OF-CP54-120	CORNER POLE	(H) 1200	1
OF-EP54-165	END POLE	(H) 1650	2
OF-EP54-120	END POLE	(H) 1200	1
OF-EP54-45	END POLE	(H) 450	1
OF-NL-LS15	L SHAPE TABLE - NOVA SERIES	(W) 1500 * (D) 600 * (H) 750	1
OF-NV-LS15FP	L SHAPE TABLE WITH FIXED PEDESTAL - NOVA SERIES	(W) 1500 * (D) 600 * (H) 750	1
OF-FO-15M-BC	SLIDING DOOR + OPEN SHELF CABINET	(W) 1500 * (D) 450 * (H) 750	1

OPENNESS WHICH UNITES

Panels in a variety of heights, widths together with glass or polycarbonate provide flexible configurations that combine in any way the user desires.

Be it manager or staff workstations, integrated discussion area, they can be configured to suit your organization's specific needs.

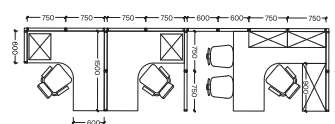

BLOCK SYSTEM PANEL (55 mm THK)

MODEL	DESCRIPTION	SPECIFICATION (mm)	QTY
OF-FFBT-165 X 75	FULL FABRIC C/W BOTTOM TRUNKING	(H) 1650 * (W) 750	4
OF-FFBT-165 X 60	FULL FABRIC C/W BOTTOM TRUNKING	(H) 1650 * (W) 600	2
OF-HGBT-165 X 75	HALF GLASS C/W BOTTOM TRUNKING	(H) 1650 * (W) 750	2
OF-FFBT-135 X 75	FULL FABRIC C/W BOTTOM TRUNKING	(H) 1350 * (W) 750	6
OF-FFBT-135 X 60	FULL FABRIC C/W BOTTOM TRUNKING	(H) 1350 * (W) 600	1
OF-CP 165	CORNER POST	(H) 1650	1
OF-CP 135	CORNER POST	(H) 1350	1
OF-TP 165	TEE POSH	(H) 1650	1
OF-TP 135	TEE POST	(H) 1350	1
OF-EP 165	END POST	(H) 1650	2
OF-EP 135	END POST	(H) 1350	2
CUS-EP 30	END POST	(H) 300	1
OF-HC-75	HANGING CABINET	(W) 750 * (D) 350 * (H) 450	1
OF-HB-75	HANGING BOOK SHELF	(W) 750 * (D) 300 * (H) 240	1
OF-FL-LS18	L SHAPE TABLE - FLEXX SERIES	(W) 1800 * (D) 600 * (H) 750	1
OF-FL-LS15FP	L SHAPE TABLE WITH FIXED PEDESRAL - FLEXX SERIES	(W) 1500 * (D) 600 * (H) 750	2
OF-FL-90-D2	SLIDING DOOR CABINET - FLEXX SERIES	(W) 900 * (D) 450 * (H) 750	1

CALL FOR **BEST PRICE**

SPEX COLOUR CHART



FRAME COLOUR





MODULAR CONCEPT

The spine panels make up the main frame, providing the cable management system while the light weighted full glass panels are designed to provide privacy.

A flexible combination of fixed and mobile units offers different working requirements for individuals and teams.

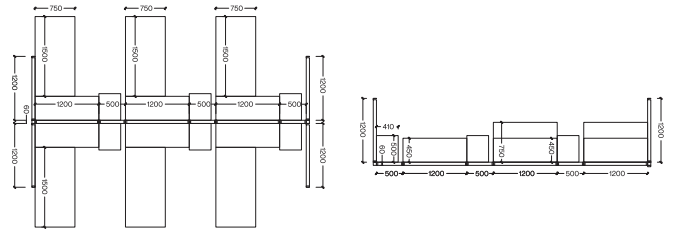

BLOCK SYSTEM PANEL (60 mm THK)

MODEL	DESCRIPTION	SPECIFICATION (mm)	QTY
OF60-FGP 1200 X 1500	FULL GLASS PANEL C/W BASE RACEWAY	(H) 1500 * (W) 1200	6
OF60-HGP 1050 X 1500	HALF GLASS PANEL C/W BASE RACEWAY	(H) 1500 * (W) 1050	6
OF60-FFP 500 X 1500	FULL FABRIC PANEL C/W BASE RACEWAY	(H) 1500 * (W) 500	6
OF60-CP-3W-1500	3 WAY CONNECTING POLE	(H) 1500	2
OF60-CP-2W-1500	2 WAY CONNECTING POLE	(H) 1500	2
OF60-EP 1500	END POLE	(H) 1500	6
P-WT 105 X 45	RECTANGULAR WORKTOP	(W) 1050 * (D) 450 * 25T	9
OF80-CB(L)	CANTILEVERED BRACKET (LEFT)	STD	9
OF80-CB(R)	CANTILEVERED BRACKET (RIGHT)	STD	9
OF-FZ-MT5	STRAIGHT MAIN TABLE - FUZE SERIES	(W) 1500 * (D) 750 * (H) 750	6
CUS-FZ-MT4	CUSTOMADE STRAIGHT MAIN TABLE - FUZE SERIES	(W) 1050 * (D) 750 * (H) 750	2
OFP-MC	OFIS MOBILE CABINET - PREMIER SERIES	(W) 411 * (D) 500 * (H) 1200	9

CALL FOR
**BEST
PRICE**

MODULAR CONCEPT

A combination of high and low panels provides storage space along the main frame while the low panels promote constructive teamwork interaction, creating a comfortable and effective working environment.

And they make the activities of those who work there much easier.

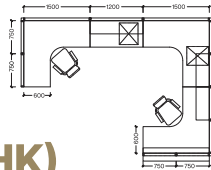

BLOCK SYSTEM PANEL (60 mm THK)

MODEL	DESCRIPTION	SPECIFICATION (mm)	QTY
OF60-FFP 750 X 1200	FULL FABRIC PANEL C/W MIDDLE RACEWAY	(H) 1200 * (W) 750	5
OF60-FFP 1500 X 1200	FULL FABRIC PANEL C/W MIDDLE RACEWAY	(H) 1200 * (W) 1500	1
OF60-FFP 1200 X 1500	FULL FABRIC PANEL C/W MIDDLE RACEWAY	(H) 1500 * (W) 1200	1
OF60-HGP 1500 X 1500	HALF GLASS PANEL C/W MIDDLE RACEWAY	(H) 1500 * (W) 1500	1
OF60-HGP 750 X 1500	HALF GLASS PANEL C/W MIDDLE RACEWAY	(H) 1500 * (W) 750	1
OF60-FFP 750 X 1500	FULL PANEL C/W MIDDLE RACEWAY	(H) 1500 * (W) 750	2
OF60-CP-2W-1200	2 WAY CONNECTING POLE	(H) 1200	2
OF60-CP-2W-1500	2 WAY CONNECTING POLE	(H) 1500	1
OF60-EP1200	END POLE	(H) 1200	2
OF60-EP300	END POLE	(H) 300	2
OF-C 150 X 30	COUNTER TOP	(W) 1500 * (D) 300	1
OF-PT-CTB	COUNTER TOP BRACKET	STD	4
OF-HC-120(SF)	SOFT CLOSING HANGING CABINET	(W) 1200 * (D) 35 X (H) 450	1
OF-HSDC-75	HANGING SWING DOOR CABINET	(W) 750 * (D) 350 X (H) 450	1
OF-HC-75	HANGING BOOK SHELF	(W) 750 * (D) 300 X (H) 240	1
OF60-HCB(L)	HANGING CABINET BRACKET (LEFT)	STD	3
OF60-HCB(R)	HANGING CABINET BRACKET (RIGHT)	STD	3
OF-EZ-LS15	L SHAPE TABLE - EAZY SERIES	(W) 1500 * (D) 600 * (W) 1500 * (D) 600 * (H) 750	3
OF-EZ-MT4	STRAIGHT MAIN TABLE - EAZY SERIES	(W) 1200 * (D) 750 * (H) 750	1
OF-FS-H3D	HIGH 3 DRAWERS - FS SERIES	(W) 410 * (D) 500 X (H) 640	2

CALL FOR
**BEST
PRICE**

SPEX COLOUR CHART



FRAME COLOUR



MODULAR CUBICLE OFFICE CONCEPT

The cubicle office concept is the ideal synthesis of concentrated work and communication, allowing spontaneous interaction. Interchangeable free-standing and panel-supported modules create private office to conform individual needs and requirements. Its different heights and widths can be easily set up to best satisfy the characteristics of individual employees and office layout needs with an effectiveness that maximizes work efficiency.

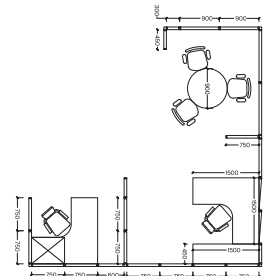

TILES SYSTEM PANEL (60 mm THK)

CALL FOR BEST PRICE

MODEL	DESCRIPTION	SPECIFICATION (mm)	QTY
OF60T-HGP 750 X 1200	FULL FARBIC PANEL C/W BASE RACEWAY	(H) 1200 * (W) 750	2
OF60T-HGP 750 X 1500	HALF GLASS PANEL C/W BASE RACEWAY	(H) 1500 * (W) 750	2
OF60T-FFP 750 X 1500	FULL FARBIC PANEL C/W BASE RACEWAY	(H) 1500 * (W) 750	9
OF60T-FFP 600 X 1500	FULL FARBIC PANEL C/W BASE RACEWAY	(H) 1500 * (W) 600	1
OF60T-FFP 450 X 1500	FULL FARBIC PANEL C/W BASE RACEWAY	(H) 1500 * (W) 450	3
OF60T-HGP 900 X 1500	HALF GLASS PANEL C/W BASE RACEWAY	(H) 1500 * (W) 900	1
OF60T-HGP 1200 X 1500	HALF GLASS PANEL C/W BASE RACEWAY	(H) 1500 * (W) 1200	2
OF60T-FFP 900 X 1500	FULL FARBIC PANEL C/W BASE RACEWAY	(H) 1500 * (W) 900	2
OF60T-FFP 300 X 1500	FULL FARBIC PANEL C/W BASE RACEWAY	(H) 1500 * (W) 300	1
OF60T-CP-3W-1500	3 WAY CONNECTING POLE	(H) 1500	2
OF60T-CP-2W-1500	2 WAY CONNECTING POLE	(H) 1500	4
OF60T-EP 1500	END POLE	(H) 1500	4
OF-LP-LS15	L SHAPE TABLE - NOVA SERIES	(W) 1500 * (D) 600 * (W) 1500 * (D) 600 * (H) 750	1
OF-LP-LS15FP	L SHAPE TABLE WITH FIXED PEDESTL - NOVA SERIES	(W) 1500 * (D) 600 * (W) 1500 * (D) 600 * (H) 750	1
OFP-SLOS1575	SLIDING DOOR + OPEN SHELF CABINET	(W) 1500 * (D) 450 X (H) 750	1
OF-RDT90(012L)	ROUND DISCUSSION TABLE C/W CROSS LEG	(Ø) 900 X (H) 750	1

PRIVACY AND INDEPENDENCE

Go vertical with different panel height variations using stack-on tiles, allowing greater flexibility in re-configurations, with individual storage space made expandable through addition of hanging cabinets.

Extend extra privacy with the use of sliding door modular element to nurture think-tanks.

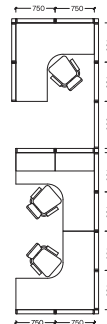

TILES SYSTEM PANEL (80 mm THK)

MODEL	DESCRIPTION	SPECIFICATION (mm)	QTY
OF80T-FFP 750 X 1200	FULL FARBIC PANEL C/W BASE RACEWAY	(H) 1200 * (W) 750	4
OF80T-FFP 750 X 1650	FULL FARBIC PANEL C/W BASE RACEWAY	(H) 1650 * (W) 750	6
OF80T-HGP 600 X 1650	HALF GLASS PANEL C/W BASE RACEWAY	(H) 1650 * (W) 600	1
OF80T-FFP 900 X 1650	FULL FARBIC PANEL C/W BASE RACEWAY	(H) 1650 * (W) 900	1
OF80T-HGP 750 X 1650	HALF GLASS PANEL C/W BASE RACEWAY	(H) 1650 * (W) 750	4
OF80T-CP-3W-1650	3 WAY CONNECTING POLE	(H) 1650	1
OF80T-CP-2W-1650	2 WAY CONNECTING POLE	(H) 1650	4
OF80T-EP 1650	END POLE	(H) 1650	3
OF80-CB(L)	CANTILEVERED BRACKET (LEFT)	STD	3
OF80-CB(R)	CANTILEVERED BRACKET (RIGHT)	STD	3
OF80-CB(M)	CANTILEVERED BRACKET (MIDDLE)	STD	1
OF80-UB(L)	UNIVERSAL BRACKET (LEFT)	STD	1
OF80-UB(R)	UNIVERSAL BRACKET (RIGHT)	STD	1
OF80-HCB(L)	HANGANG CABINET BRACKET (LEFT)	STD	2
OF80-HCB(R)	HANGANG CABINET BRACKET (RIGHT)	STD	2
P-LWT 150 X 60	L-SHAPE WORKTOP	(W) 1500 * (D) 600 * (W) 1500 * (D) 600 * 25T	2
OFP-FP2D1F	FIXED PEDESTAL 2D1F - PREMIER SERIES	(W) 405 * (D) 495 * (H) 725	2
OF-HC-75(SF)	SOFT CLOSING HANGING CABINET -	(W) 750 * (D) 35 * (H) 450	2
OF-ML-LS15	L SHAPE TABLE - MILA SERIES	(W) 1500 * (D) 600 * (W) 1500 * (D) 600 * (H) 750	1
OF-ML-H3D	HIGH 3 DRAWERS - MILA SERIES	(W) 410 * (D) 500 X (H) 640	1

CALL FOR BEST PRICE

SPEX COLOUR CHART



FRAME COLOUR





● **MODULAR WORKSTATION**



● **EXECUTIVE WORKSTATION**



● **HOTDESKING**



● **CLUSTER CONFIGURATION**



● **INTERACTIVE CONFIGURATION**

01 VARIETY OF CONFIGURATIONS

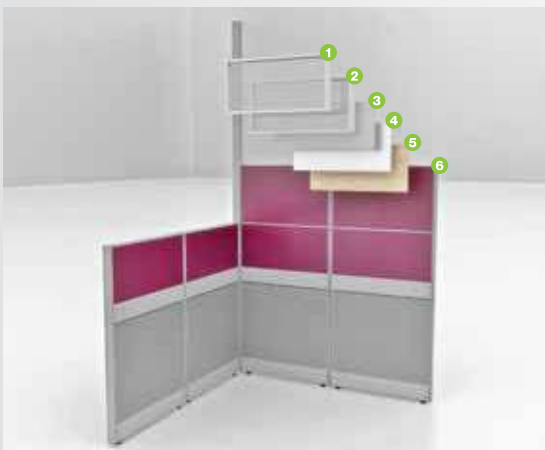

● **OPTIONAL PANEL FINISHES**

- 1 GLASS / ACRYLIC
- 2 POLYCARBONATE SHEET
- 3 PERFORATED METAL SHEET
- 4 MAGNETIC WHITEBOARD
- 5 MELAMINE / LAMINATED BOARD
- 6 FABRIC UPHOLSTERED

02 PARTITION SPECIFICATION

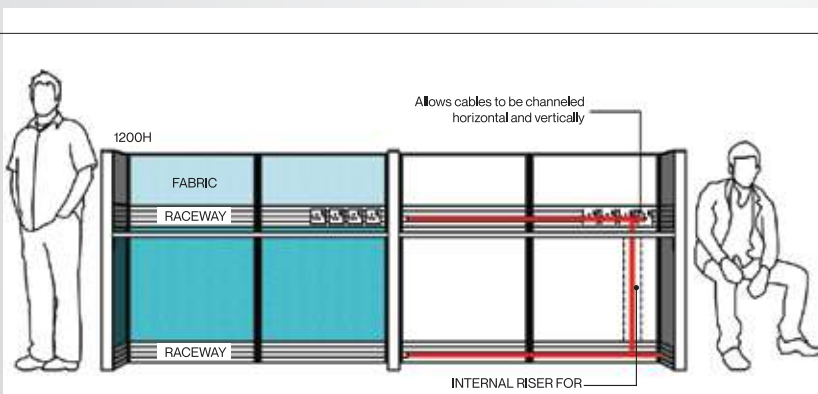

03 WIRE MANAGEMENT

ERGONOMIC, FUNCTIONAL, EFFICIENT

04

Ceiling height partition maximum capacity of 50kg load

Ceiling Height
(Only Link 6H & Link 12)

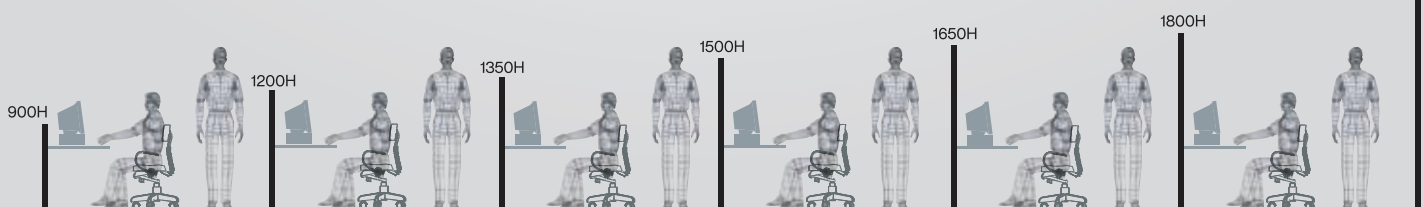

LIGHT DUTY RACKING SYSTEM SERIES



4 LEVEL BOLTLESS RACK - (YELLOW / BLUE / BEIGE)																	
CODE	(D)	(L)	(H)	HDF	EXTRA SHELF	CODE	(D)	(L)	(H)	HDF	EXTRA SHELF	CODE	(D)	(L)	(H)	HDF	EXTRA SHELF
OF1248724L			72"	RM 245	RM 45	OF1848724L			72"	RM 278	RM 60	OF2436724L			72"	RM 258	RM 58
OF1248844L	12"	48"	84"	RM 255	RM 45	OF1848844L	18"	48"	84"	RM 288	RM 60	OF2436844L	24"	36"	84"	RM 268	RM 58
OF1248964L			96"	RM 265	RM 45	OF1848964L			96"	RM 298	RM 60	OF2436964L			96"	RM 278	RM 58
OF1260724L			72"	RM 275	RM 55	OF1860724L			72"	RM 318	RM 65	OF2448724L			72"	RM 308	RM 65
OF1260844L	12"	60"	84"	RM 295	RM 55	OF1860844L	18"	60"	84"	RM 328	RM 65	OF2448844L	24"	48"	84"	RM 318	RM 65
OF1260964L			96"	RM 305	RM 55	OF1860964L			96"	RM 338	RM 65	OF2448964L			96"	RM 328	RM 65
OF1272724L			72"	RM 325	RM 65	OF1872724L			72"	RM 368	RM 78	OF2460724L			72"	RM 348	RM 75
OF1272844L	12"	72"	84"	RM 335	RM 65	OF1872844L	18"	72"	84"	RM 378	RM 78	OF2460844L	24"	60"	84"	RM 368	RM 75
OF1272964L			96"	RM 345	RM 65	OF1872964L			96"	RM 378	RM 78	OF2460964L			96"	RM 378	RM 75
OF1296724L			72"	RM 385	RM 85	OF1896724L			72"	RM 448	RM 98	OF2472724L			72"	RM 398	RM 88
OF1296844L	12"	96"	84"	RM 395	RM 85	OF1896844L	18"	96"	84"	RM 458	RM 98	OF2472844L	24"	72"	84"	RM 408	RM 88
OF1296964L			96"	RM 405	RM 85	OF1896964L			96"	RM 478	RM 98	OF2472964L			96"	RM 418	RM 88
												OF2496724L			72"	RM 498	RM 115
												OF2496844L	24"	96"	84"	RM 508	RM 115
												OF2496964L			96"	RM 518	RM 115

*Due to heavy fluctuation in steel raw material price, steel product pricing is subject to change without prior notice.



4 LEVEL BOLTLESS METAL RACK - (BEIGE)																	
CODE	(D)	(L)	(H)	METAL	EXTRA SHELF	CODE	(D)	(L)	(H)	METAL	EXTRA SHELF	CODE	(D)	(L)	(H)	METAL	EXTRA SHELF
OF-423672-MB-4L			72"	RM 308	RM 58	OF-483672-MB-4L			72"	RM 388	RM 80	OF-243672-MB-4L			72"	RM 478	RM 98
OF-423684-MB-4L	12"	36"	84"	RM 318	RM 58	OF-483684-MB-4L	18"	36"	84"	RM 398	RM 80	OF-243684-MB-4L	24"	36"	84"	RM 488	RM 98
OF-423696-MB-4L			96"	RM 328	RM 58	OF-483696-MB-4L			96"	RM 408	RM 80	OF-243696-MB-4L			96"	RM 498	RM 98
OF-424872-MB-4L			72"	RM 428	RM 80	OF-484872-MB-4L			72"	RM 508	RM 108	OF-244872-MB-4L			72"	RM 618	RM 130
OF-424884-MB-4L	12"	48"	84"	RM 438	RM 80	OF-484884-MB-4L	18"	48"	84"	RM 518	RM 108	OF-244884-MB-4L	24"	48"	84"	RM 638	RM 130
OF-424896-MB-4L			96"	RM 458	RM 80	OF-484896-MB-4L			96"	RM 528	RM 108	OF-244896-MB-4L			96"	RM 648	RM 130
OF-427272-MB-4L			72"	RM 518	RM 98	OF-487272-MB-4L			72"	RM 668	RM 108	OF-247272-MB-4L			72"	RM 828	RM 188
OF-427284-MB-4L	12"	72"	84"	RM 538	RM 98	OF-487284-MB-4L	18"	72"	84"	RM 688	RM 108	OF-247284-MB-4L	24"	72"	84"	RM 848	RM 188
OF-427296-MB-4L			96"	RM 578	RM 98	OF-487296-MB-4L			96"	RM 698	RM 108	OF-247296-MB-4L			96"	RM 858	RM 188



Metal Shelves



HDF Board / Plywood



Metal Shelf Plate



AP Slim Stopper (APSS)



Boltless Hamper Rack



Pigeon Hole Boltless Rack



Boltless Rack + Multi Tool Box



Boltless Workbench



Mobile Boltless Rack

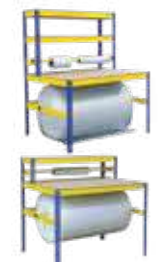

Boltless Rack Packing Table



RACKING ACCESSORIES MULTI TOOL BOX

Model	Size (mm) (W*L*H)	Model	Size (mm) (W*L*H)
MTB 1188	92*130*60	MTB 1588	150*250*120
MTB 1288	120*180*82	MTB 1600	200*300*135
		MTB 1688	245*355*140
		MTB 1988	295*480*175
Available Colours ● ●		Available Colours ● ● ● ● ●	

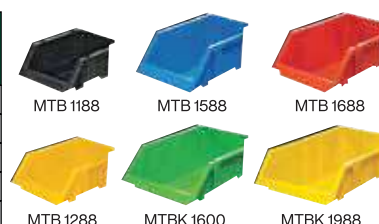

CALL FOR BEST PRICE

*Images provided are for illustration purposes only. *Prices quoted are subject to change without prior notice & while stocks last. *Terms & conditions apply. *While every care is taken in the preparation of this flyer any inaccuracy or omission is much regretted.

MEDIUM / HEAVY DUTY RACKING SYSTEM SERIES



Height (mm)	900	1200	1500	1800	2100	2400	2700	3000	3300	3600	3900	4200	4500
	4800	5100	5400	5700	6000	6300	6600	6900	7200	7500	-	-	-
Depth (mm)	450	600	750	900	1000	1200	1500	-	-	-	-	-	-
Length (mm) C/E	900	1200	1350	1500	1800	2100	2400	2700	3000	3300	3600	-	-
Shelve Level	2	3	4	5	6	(available customize)							
Decking Material	12mm High Density Fiber Board / Pywood / Metal Shelve												
Loading Capacity (kg)	500 kg - 3000 kg UDL / level												
Colour	Beam ■ ■ ■			Frame Set ■ ■									



TWIN-BAY RACKING SYSTEM



NARROW AISLE RACKING SYSTEM



DOUBLE DEEP RACKING SYSTEM



DRIVE-IN RACKING SYSTEM



HEAVY DUTY SHELVING C/W MEZZANINE FLOOR



CANTILEVER RACKING SYSTEM



TRUSS SYSTEM MEZZANINE FLOOR



STEEL PLATFORM



SELECTIVE PALLET RACKING SYSTEM



PALLET / CARTON FLOW SYSTEM



SHUTTLE RACK



GONDOLA SHELVING SYSTEM SERIES



Island Gondola



Wall Gondola



End Gondola

GONDOLA SHELVING SYSTEM

HEIGHT		DEPTH		LENGTH		BACK COVER	DECKING MATERIAL	LOADING CAPACITY KG	COLOUR
mm	ft	mm		mm					
1192	4	342		DIMENSION OF SHELVES EXCLUDE UPRIGHT	905	METAL PLATE / METAL PERFORATED / NETTING	METAL SHELVING PLATE	60KG UDL / SHELF	<input type="checkbox"/> BLACK <input type="checkbox"/> WHITE
1492	5	(shelving)			1210				
1792	6								
2092	7	400							
2390	8	(Bottom Shelve)							



Mini Island Gondola



Mini Wall Gondola



End Gondola

MINI GONDOLA SHELVING SYSTEM

HEIGHT		DEPTH		LENGTH		BACK COVER	DECKING MATERIAL	LOADING CAPACITY KG	COLOUR
mm	ft	mm		mm					
1192	4	245		DIMENSION OF SHELVES EXCLUDE UPRIGHT	605	METAL PLATE / METAL PERFORATED / NETTING	METAL SHELVING PLATE	60KG UDL / SHELF	<input type="checkbox"/> BLACK <input type="checkbox"/> WHITE
1492	5	(shelving)			905				
1792	6				1210				
2092	7	245							
2300	8	(Bottom Shelve)							

CHILLER GONDOLA SHELVING SYSTEM



MINISO ISLAND WOODEN DISPLAY RACK



MINISO ISLAND WOODEN DISPLAY RACK WITH BACK PLATE



CT90180W6S-WH



CT9055-WH

CT90180W6S-BK



CT9055-BK



CASHIER COUNTER

PRODUCT CODE	DESCRIPTION	HEIGHT X DEPTH X LENGTH	REMARKS
CT90180W6S-WH	CASHIER COUNTER 900H X 1800L X c/w 6 SHELF	900 X 550 X 1800 mm	COME WITH 6 SHELF
CT90180W6S-BK			
CT9055-WH	SIDE TABLE 900H X 550L	900 X 500 X 550 mm	-
CT9055-BK			

COLOUR:



WHITE



BLACK

FB51430 RACKING

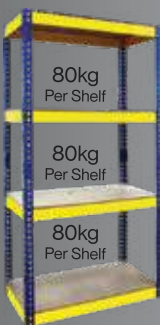

80kg Per Shelf
80kg Per Shelf
80kg Per Shelf

SIZE (mm) :
W750*D350*H1534

DIY RACKING

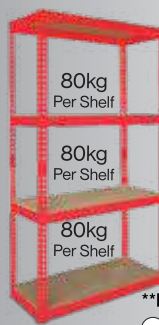

80kg Per Shelf
80kg Per Shelf
80kg Per Shelf

SIZE (mm) :
W900*D350*H1710

**HDF BOARD



PICCOLO RACK



SIZE (mm) :
W600*D350*H1539

**HDF BOARD



2 in 1 RACK



SIZE (mm) :
W900*D350*H1829



OFIS FILING CABINET

OFIS Filing Cabinets have been created specifically for commercial use and are ideal for high volume storage where floor storage space is restricted.

- **Recess Handle** : The recessed handle provides a large opening for your hand, allowing simple and smooth opening and closing of the drawers.
- **Ball Bearing Slide** : To keep the sliding smooth.
- **Locking Bar (Optional)**



OF-S106/5A



OF-S106/ABLB



OF-S106/AB



OF-S106/BB



OF-S106/CB

Specification:



Recess Handle



Ball Bearing Slide

TECHNICAL SPECIFICATION

CODE	DESCRIPTION	SIZE (W*D*H mm)	PRICE
OF-S106/5ALB	5 DRAWER c/w LOCKING BAR	465*625*1620	RM 728
OF-S106/5A	5 DRAWER	465*625*1620	RM 588
OF-S106/ABLB	4 DRAWER c/w LOCKING BAR	465*625*1320	RM539
OF-S106/AB	4 DRAWER	465*625*1320	RM399
OF-S106/BBLB	3 DRAWER c/w LOCKING BAR	465*625*1020	RM 535
OF-S106/BB	3 DRAWER	465*625*1020	RM 395
OF-S106/CBLB	2 DRAWER c/w LOCKING BAR	465*625*720	RM 530
OF-S106/CB	2 DRAWER	465*625*720	RM 390

COLOUR OPTION



COLOUR OPTION - Additional charge **RM100 per unit**



LATERAL FILING CABINET SERIES STEEL SERIES



OFIS PREMIER LATERAL

Lateral Filing Cabinets are durable and designed for storing high volumes of suspension filing. These lockable cabinets feature an anti-tilt safety mechanism and heavy-duty double extension runners.

- **Goose Neck Profile**
- **Full Extension Ball Bearing**
- **Anti-Tilt**
- **Central Locking System**



LF20

LF30

LF40

TECHNICAL SPECIFICATION

CODE	DESCRIPTION	SIZE (W*D*H mm)	PRICE
LF20	2 DRAWER LATERAL FILING CABINET	900*450*725	RM 888
LF30	3 DRAWER LATERAL FILING CABINET	900*450*1025	RM 1088
LF40	4 DRAWER LATERAL FILING CABINET	900*450*1316	RM 1248

COLOUR





CARD RECORD CABINET VERTICAL PLAN FILE CABINET HORIZONTAL PLAN FILE CABINET



OFIS PREMIER CARD RECORD / PLAN FILE CABINET

Plan Cabinets are designed specifically to store and protect plans, drawings and maps. The drawer size allows for paper up to size A0.

COLOUR OPTION



TECHNICAL SPECIFICATION

CODE	DESCRIPTION	SIZE (W*D*H mm)	PRICE
7 DCR	7 DRAWER CARD RECORD	520*610*1320	RM 2,288
9 DCR	7 DRAWER CARD RECORD	425*610*1320	RM 2,388
11 DCR	7 DRAWER CARD RECORD	370*610*1320	RM 2,486
OF-VPA1	VERTICAL PLAN FILE - A1	915*508*1321	RM 2,288
OF-VPA0	VERTICAL PLAN FILE - A0	1499*508*1321	RM 3,988
OF-HPA1	6 DRAWER HORIZONTAL PLAN FILE - A1	1169*965*711	RM 2,288
OF-HPA0	6 DRAWER HORIZONTAL PLAN FILE - A0	1499*965*711	RM 3,988

MOBILE PEDESTAL SERIES STEEL SERIES

Specification:



Ball Bearing Slide



OF-S180

OF-S181

OF-S182



OFIS MOBILE PEDESTAL

When it comes to an individual employee's storage, mobile pedestals are the perfect option. These pedestals are a flexible desk storage solution that fits underneath the desk with ease while having a range of configurations that suit the specific requirements for more or less storage space.

- Ball Bearing Slide

COLOUR OPTION



TECHNICAL SPECIFICATION

CODE	DESCRIPTION	SIZE (W*D*H mm)	PRICE
OF-S180	2 DRAWER + 1 FILING with BALL BEARING	400*490*680	RM 438
OF-S181	3 DRAWER with BALL BEARING	400*490*550	RM 428
OF-S182	3 DRAWER + 1 FILING with BALL BEARING	400*490*530	RM 418

COLOUR OPTION - Additional charge **RM80 per unit**

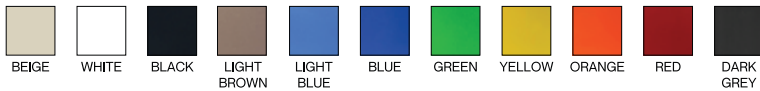

SHOE RACK SERIES STEEL SERIES

TECHNICAL SPECIFICATION

CODE	DESCRIPTION	SIZE (W*D*H mm)	PRICE
OF-S168	4 FIXED SHELVES SHOE RACK	1000*400*800	RM 638

COLOUR



COLOUR OPTION - Additional charge **RM100 per unit**

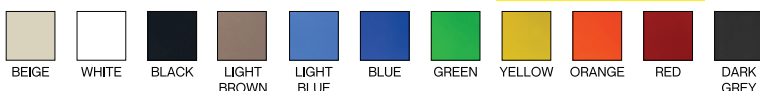

*Images provided are for illustration purposes only. • Prices quoted are subject to change without prior notice & while stocks last. • Terms & conditions apply. • While every care is taken in the preparation of this flyer any inaccuracy or omission is much regretted.

FULL HEIGHT CABINET SERIES STEEL SERIES



*ADD ON SHELF FOR S118|S118W|S118W-GS|S116|S119
ADDITIONAL CHARGE RM 95 PER SHELF

CALL FOR BEST PRICE



Numbering Lock



OFIS FULL HEIGHT CABINET

Ideal for storing documents and valuable items. Shelves can be adjusted in height to maximise storage capacity. Storage Cabinets are available in various heights, widths, and configurations.

- **Adjustable Shelves** : Shelves are easily adjustable
- **Locking Bar** : Optional for Item S118

TECHNICAL SPECIFICATION

STANDARD SIZE (W*D*H mm)

915*457*1828

CODE	DESCRIPTION	ADJUSTABLE SHELVES	PRICE
SCM-0008	FULL HEIGHT CUPBOARD WITH UPPER PART C/W GLASS SWINGING DOOR	3	RM 1,238
OF-S118	STEEL SWING DOOR	3	RM 458
OF-S118W	OPEN SHELF	3	RM 428
OF-S116	STEEL SLIDING DOOR	3	RM 555
OF-S119	GLASS SLIDING DOOR	3	RM 585
OF-S118GS	GLASS SWING DOOR	3	RM 585
OF-S118LB	STEEL SWING DOOR c/w LOCKING BAR	3	RM 598

COLOUR OPTION



COLOUR OPTION - Additional charge **RM150 per unit**

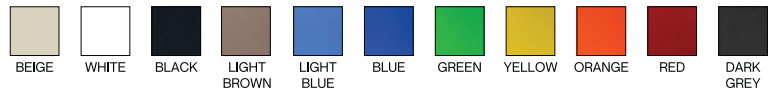

HALF HEIGHT CABINET SERIES STEEL SERIES



*ADD ON SHELF FOR S110|S111|S112|ST112-2V|S112
ADDITIONAL CHARGE RM 95 PER SHELF

CALL FOR BEST PRICE



Numbering Lock



OFIS HALF HEIGHT CABINET

OFIS Half Height Cabinets are ideal for office storage needs. With adjustable shelves, you will be able to easily store a variety of office goods.

- **Adjustable Shelves** : Shelves are easily adjustable
- **Locking Bar** : Optional for Item S112

TECHNICAL SPECIFICATION

STANDARD SIZE (W*D*H mm)

915*457*915

*2 SHELVING SIZE (W*D*H mm)

915*457*1016

CODE	DESCRIPTION	ADJUSTABLE SHELVES	PRICE
OF-S110	GLASS SLIDING DOOR	1	RM 399
OF-S111	STEEL SLIDING DOOR	1	RM 385
OF-S112	STEEL SWING DOOR	1	RM 375
OF-S112W	OPEN SHELF	1	RM 365
*OF-S112-2SV	STEEL SWING DOOR - 2 SHELVING	2	RM 399
*OF-S112W-2SV	OPEN SHELF - 2 SHELVING	2	RM 389

COLOUR OPTION



COLOUR OPTION - Additional charge **RM120 per unit**

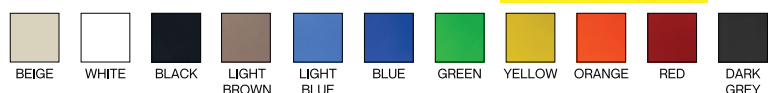

OFIS WARDROBE

OFIS Wardrobe offers a combination of hanging and shelf storage space. This product is ideal for storing personal items such as clothing, shoes, & helmets.

- Clothes Hanging Bar
- Fixed Shelves
- Adjustable Shelves
- Mirror



OF-S198



OF-S199



OF-S200



OF-SCM-0001



OF-SCM-0002



WR10
*LIGHT GREY & TWO TONE only



WR50
*LIGHT GREY & TWO TONE only

TECHNICAL SPECIFICATION

CODE	DESCRIPTION	SIZE (W*D*H mm)	PRICE
OF-S198	OFIS F/H WARDROBE W/SWING DOOR	915 * 525 * 1828	RM 738
OF-S199	OFIS F/H WARDROBE - 1SHF/1BAR	915 * 457 * 1828	RM 538
OF-S200	OFIS F/H WARDROBE - 1BAR/1SHF	915 * 457 * 1828	RM 538
OF-SCM-0001	FULL HEIGHT WARDROBE C/W SWING DOOR	750 * 470 * 2100	RM 1,038
OF-SCM-0002	SINGLE DOOR WARDROBE	457 * 508 * 1828	RM 548
WR10	SINGLE DOOR WARDROBE	457 * 457 * 1828	RM 585
WR50	F/H 2 DOOR DOMESTIC WARDROBE	900 * 457 * 1850	RM 788

COLOUR OPTION



COLOUR OPTION - Additional charge **RM150 per unit**



*Images provided are for illustration purposes only. *Prices quoted are subject to change without prior notice & while stocks last. *Terms & conditions apply. *While every care is taken in the preparation of this flyer any inaccuracy or omission is much regretted.



OFIS SINGLE LOCKER

OFIS Single Locker offer a comprehensive range of robust steel lockers to suit any demanding conditions or environment. Designed and manufactured to the highest standards, the locker units are available in a variety of sizes and powder coated finishes.

• Clothes Hanging Bar:

For Item S114/D/DS + S114/C/CS

• Fixed Shelves:

For Item S114/D/DS + S114/C/CS



Handle Camlock



Handle Latch Lock
+ RM 2.00 per door



Digital Combination Lock
+ RM 30.00 per door



Ear Hinge
+ RM 30.00 per door

TECHNICAL SPECIFICATION STANDARD SIZE (W*D*H mm)

381*381*1828 381*457*1828

CODE	DESCRIPTION	PRICE	PRICE
OF-S114/D DS	1 COMPARTMENT	RM 265	RM 305
OF-S114/C CS	2 COMPARTMENT	RM 275	RM 315
OF-S114/3 3S	3 COMPARTMENT	RM 280	RM 320
OF-S114/B BS	4 COMPARTMENT	RM 285	RM 325
OF-S114/E ES	5 COMPARTMENT	RM 295	RM 340
OF-S114/A AS	6 COMPARTMENT	RM 298	RM 345
OF-SCM-0005	12 COMPARTMENT	RM 728	-

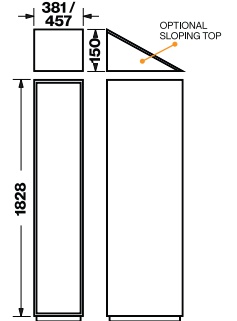

CALL FOR BEST PRICE

COLOUR OPTION



COLOUR OPTION - Additional charge RM100 per unit



HALF HEIGHT LOCKER SERIES STEEL SERIES



OF-S127 & OF-S128 SERIES



OF-S129 & OF-S130 SERIES

OFIS HALF HEIGHT LOCKER

OFIS offer a comprehensive range of robust steel lockers to suit any demanding conditions or environment. Designed and manufactured to the highest standards, the locker units are available in a variety of sizes and powder coated finishes.

• Ventilation Hole

CODE	DESCRIPTION	SIZE (W*D*H mm)	PRICE
OF-S127/A	6 COMPARTMENT	915*381*915	RM 608
OF-S127/AS	6 COMPARTMENT	915*457*915	RM 638
OF-S128/A	6 COMPARTMENT	1143*381*915	RM 668
OF-S128/AS	6 COMPARTMENT	1143*457*915	RM 688
OF-S129/A	9 COMPARTMENT	915*381*915	RM 648
OF-S129/AS	9 COMPARTMENT	915*457*915	RM 688
OF-S130/A	9 COMPARTMENT	1143*381*915	RM 708
OF-S130/AS	9 COMPARTMENT	1143*457*915	RM 728

COLOUR OPTION



COLOUR OPTION - Additional charge RM100 per unit



OFIS MULTI LOCKER

Multi locker are designed to suit most conditions. They are the perfect locker solution for any indoor use in a school, fitness centre, swimming pool or factory.

- Clothes Hanging Bar :
For Item OF-S140, S138, S141 & S139
- Fixed Shelves :
For Item OF-S140, S138, S141 & S139
- Ventilation Hole
- Locker

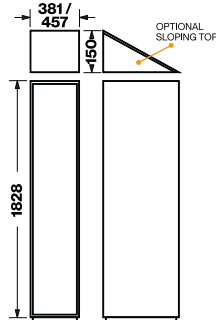

CALL FOR BEST PRICE



Handle Camlock



Handle Latch Lock
+ RM 2.00 per door



Digital Combination Lock
+ RM 30.00 per door

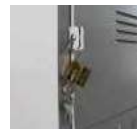

Ear Hinge
+ RM 30.00 per door



OF-S140 & OF-S138 SERIES



OF-S141 & OF-S139 SERIES



OF-S105 & OF-S135 SERIES



OF-S107 & OF-S108 SERIES



OF-S125 & OF-S126 SERIES



OF-S109 & OF-S115 SERIES



OF-S109(GS) & OF-S115(GS) SERIES
(c/w GLASS WINDOW)



OF-SCM-0003

TECHNICAL SPECIFICATION

CODE	DESCRIPTION	SIZE (W*D*H mm)	PRICE
OF-S140/A	TRIPLE COLUMN, 3 COMPARTMENT	915*381*1828	RM 748
OF-S140/AS	TRIPLE COLUMN, 3 COMPARTMENT	915*457*1828	RM 778
OF-S138/A	TRIPLE COLUMN, 3 COMPARTMENT	1143*381*1828	RM 818
OF-S138/AS	TRIPLE COLUMN, 3 COMPARTMENT	1143*457*1828	RM 838
OF-S141/A	TRIPLE COLUMN, 6 COMPARTMENT	915*381*1828	RM 788
OF-S141/AS	TRIPLE COLUMN, 6 COMPARTMENT	915*457*1828	RM 818
OF-S139/A	TRIPLE COLUMN, 6 COMPARTMENT	1143*381*1828	RM 848
OF-S139/AS	TRIPLE COLUMN, 6 COMPARTMENT	1143*457*1828	RM 888
OF-S105/A	TRIPLE COLUMN, 9 COMPARTMENT	915*381*1828	RM 798
OF-S105/AS	TRIPLE COLUMN, 9 COMPARTMENT	915*457*1828	RM 828
OF-S135/A	TRIPLE COLUMN, 9 COMPARTMENT	1143*381*1828	RM 858
OF-S135/AS	TRIPLE COLUMN, 9 COMPARTMENT	1143*457*1828	RM 898
OF-S107/A	TRIPLE COLUMN, 12 COMPARTMENT	915*381*1828	RM 808
OF-S107/AS	TRIPLE COLUMN, 12 COMPARTMENT	915*457*1828	RM 858
OF-S108/A	TRIPLE COLUMN, 12 COMPARTMENT	1143*381*1828	RM 898
OF-S108/AS	TRIPLE COLUMN, 12 COMPARTMENT	1143*457*1828	RM 938

CODE	DESCRIPTION	SIZE (W*D*H mm)	PRICE
OF-S125/A	TRIPLE COLUMN, 15 COMPARTMENT	915*381*1828	RM 818
OF-S125/AS	TRIPLE COLUMN, 15 COMPARTMENT	915*457*1828	RM 868
OF-S126/A	TRIPLE COLUMN, 15 COMPARTMENT	1143*381*1828	RM 918
OF-S126/AS	TRIPLE COLUMN, 15 COMPARTMENT	1143*457*1828	RM 958
OF-S109/A	TRIPLE COLUMN, 18 COMPARTMENT	915*381*1828	RM 799
OF-S109/AS	TRIPLE COLUMN, 18 COMPARTMENT	915*457*1828	RM 908
OF-S115/A	TRIPLE COLUMN, 18 COMPARTMENT	1143*381*1828	RM 838
OF-S115/AS	TRIPLE COLUMN, 18 COMPARTMENT	1143*457*1828	RM 988
OF-S109(GS)/A	TRIPLE COLUMN, 18 COMPARTMENT	915*381*1828	RM 1,178
OF-S109(GS)/AS	TRIPLE COLUMN, 18 COMPARTMENT	915*457*1828	RM 1,218
OF-S115(GS)/A	TRIPLE COLUMN, 18 COMPARTMENT	1143*381*1828	RM 1,228
OF-S115(GS)/AS	TRIPLE COLUMN, 18 COMPARTMENT	1143*457*1828	RM 1,328
OF-SCM-0003	TRIPLE COLUMN, 36 COMPARTMENT	915*381*1828	RM 2,188

COLOUR OPTION



COLOUR OPTION - Additional charge **RM150 per unit**



*Images provided are for illustration purposes only. *Prices quoted are subject to change without prior notice & while stocks last. *Terms & conditions apply. *While every care is taken in the preparation of this flyer any inaccuracy or omission is much regretted.



LOCK TYPE



Cam Lock



Pad Lock

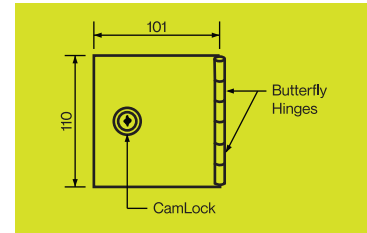

CALL FOR BEST PRICE PROJECTS WELCOME



9 Compartments
W425*D180*H446 (mm)



42 Compartments
W826*D250*H894 (mm)



72 Compartments
W826*D250*H1454 (mm)



90 Compartments
W834*D250*H1790 (mm)



120 Compartments
W1104*D250*H1790 (mm)



150 Compartments
W1380*D250*H1790 (mm)

OFIS PREMIER HANDPHONE LOCKER

With the growing use of mobile phones in everyday life, we provide an efficient storage option to securely and safely store a small array of items that are essential in this day and age such as mobile phones and keys.

- **Size Modifications** : Custom-sized lockers can be designed and manufactured to suit specific uses.
- **Lock System** : User can choose lock system.

COLOUR OPTION



PIGEON HOLE SERIES STEEL SERIES



OFIS PIGEON HOLES

We are engaged in offering the best collection of steel pigeon hole cabinet which is used to keep office files and other compact items safely.

COLOUR OPTION



COLOUR OPTION - Additional charge **RM150 per unit**



OF-S113/A



OF-S113/B



OF-SPH12 SERIES



OF-SPH15 SERIES



OF-SPH18 SERIES



OF-SCM-0004

TECHNICAL SPECIFICATION

CODE	DESCRIPTION	SIZE (W*D*H mm)	PRICE
OF-S113/A	6 PIGEON HOLE SIDE TABLE	915*381*890	RM 308
OF-S113/B	9 PIGEON HOLE SIDE TABLE	915*381*890	RM 328
OF-SPH12/3615	FULL HEIGHT 12 PIGEON HOLE	915*381*1828	RM 628
OF-SPH12/3618	FULL HEIGHT 12 PIGEON HOLE	915*457*1828	RM 648
OF-SPH12/4515	FULL HEIGHT 12 PIGEON HOLE	1143*381*1828	RM 668
OF-SPH12/4518	FULL HEIGHT 12 PIGEON HOLE	1143*457*1828	RM 688
OF-SPH15/3615	FULL HEIGHT 15 PIGEON HOLE	915*381*1828	RM 698
OF-SPH15/3618	FULL HEIGHT 15 PIGEON HOLE	915*457*1828	RM 708
OF-SPH15/4515	FULL HEIGHT 15 PIGEON HOLE	1143*381*1828	RM 718
OF-SPH15/4518	FULL HEIGHT 15 PIGEON HOLE	1143*457*1828	RM 728
OF-SPH18/3615	FULL HEIGHT 18 PIGEON HOLE	915*381*1828	RM 758
OF-SPH18/3618	FULL HEIGHT 18 PIGEON HOLE	915*457*1828	RM 768
OF-SPH18/4515	FULL HEIGHT 18 PIGEON HOLE	1143*381*1828	RM 778
OF-SPH18/4518	FULL HEIGHT 18 PIGEON HOLE	1143*457*1828	RM 788
OF-SCM-0004	FULL HEIGHT 30 PIGEON HOLE	915*457*1828	RM 1,888



OFIS STEEL DESK

Designed to fit your workplace needs, the steel desk line is a sturdy, long-lasting solution that emphasizes strength and simplicity.

TECHNICAL SPECIFICATION

CODE	DESCRIPTION	SIZE (W*D*H mm)	PRICE
OF-S101/LT	5' L-SHAPE PEDESTAL DESK (BLACK LINOLEUM TOP)	1524*762*762	RM 1,348
OF-S102/LT	4' SINGLE PEDESTAL DESK (BLACK LINOLEUM TOP)	1220*762*762	RM 598 (TWO TONE ONLY)
OF-S103/LT	5' DOUBLE PEDESTAL DESK (BLACK LINOLEUM TOP)	1524*762*762	RM 718 (TWO TONE ONLY)
OF-S101/MT	5' L-SHAPE PEDESTAL DESK (MELAMINE CHIPBOARD TOP)	1524*762*762	RM 1,498
OF-S102/MT	4' SINGLE PEDESTAL DESK (MELAMINE CHIPBOARD TOP)	1220*762*762	RM 888
OF-S103/MT	5' DOUBLE PEDESTAL DESK (MELAMINE CHIPBOARD TOP)	1524*762*762	RM 998
OF-S136	4' GENERAL PURPOSE TABLE WITH CENTRE DRAWER (BLACK LINOLEUM TOP)	1220*762*762	RM 788
OF-S137	5' GENERAL PURPOSE TABLE WITH CENTRE DRAWER (BLACK LINOLEUM TOP)	1524*762*762	RM 828
OF-S104/A	4' UTILITY TABLE (BLACK LINOLEUM TOP)	1220*762*762	RM 788
OF-S104/B	5' UTILITY TABLE (BLACK LINOLEUM TOP)	1524*762*762	RM 828

MELAMINE CHIPBOARD TOP COLOUR OPTION

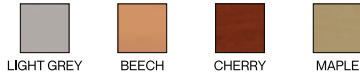

COLOUR OPTION



LIBRARY RACKING SERIES STEEL SERIES



OFIS LIBRARY RACKING

A steel book rack/bookshef. Ideal for a modern workspace or library. Plenty of storage space and can keep book, magazines etc.

TECHNICAL SPECIFICATION

CODE	DESCRIPTION	LEVEL	SIZE (W*D*H mm)	PRICE	CODE	DESCRIPTION	LEVEL	SIZE (W*D*H mm)	PRICE
OF-S315	SINGLE SIDED WITH SIDE PANEL	5	950*313*1690	RM 608	OF-S325	DOUBLE SIDED WITH SIDE PANEL	5	950*550*1690	RM 788
OF-S316	SINGLE SIDED WITH SIDE PANEL	6	950*313*1995	RM 698	OF-S326	DOUBLE SIDED WITH SIDE PANEL	6	950*550*1995	RM 848
OF-S317	SINGLE SIDED WITH SIDE PANEL	7	950*313*2300	RM 798	OF-S327	DOUBLE SIDED WITH SIDE PANEL	7	950*550*2300	RM 978
OF-S315W	SINGLE SIDED WITHOUT SIDE PANEL	5	950*313*1690	RM 578	OF-S325W	DOUBLE SIDED WITHOUT SIDE PANEL	5	950*550*1690	RM 668
OF-S316W	SINGLE SIDED WITHOUT SIDE PANEL	6	950*313*1995	RM 648	OF-S326W	DOUBLE SIDED WITHOUT SIDE PANEL	6	950*550*1995	RM 728
OF-S317W	SINGLE SIDED WITHOUT SIDE PANEL	7	950*313*2300	RM 718	OF-S327W	DOUBLE SIDED WITHOUT SIDE PANEL	7	950*550*2300	RM 878

COLOUR OPTION



SMART LOCK LOCKER 12 | 24 | 36 DOORS



SMART LOCK LOCKER 12 DOORS W1000*D450*H1800

- WITH 7 INCHES TOUCH SCREEN
- NO KEY OR RFID CARD NEEDED
- FACIAL RECOGNITION or PASS CODE CONTROL TO ACCESS INDIVIDUAL COMPARTMENT.
- SETTING FOR PUBLIC or PRIVATE USAGE.
- EASY MANAGEMENT SETTING AND CONTROL.
- SECURITY FEATURES OF USER USAGE.

SMART LOCK LOCKER 24 DOORS W2000*D450*H1800

- WITH 7 INCHES TOUCH SCREEN
- NO KEY OR RFID CARD NEEDED
- FACIAL RECOGNITION or PASS CODE CONTROL TO ACCESS INDIVIDUAL COMPARTMENT.
- SETTING FOR PUBLIC or PRIVATE USAGE.
- EASY MANAGEMENT SETTING AND CONTROL.
- SECURITY FEATURES OF USER USAGE.

SMART LOCK LOCKER 36 DOORS W3000*D450*H1800

- WITH 7 INCHES TOUCH SCREEN
- NO KEY OR RFID CARD NEEDED
- FACIAL RECOGNITION or PASS CODE CONTROL TO ACCESS INDIVIDUAL COMPARTMENT.
- SETTING FOR PUBLIC or PRIVATE USAGE.
- EASY MANAGEMENT SETTING AND CONTROL.
- SECURITY FEATURES OF USER USAGE.

ABS LOCKER



CREATING A HEALTHY & ENVIRONMENTALLY FRIENDLY WORLD



- MOISTURE RESISTANT
- WATER PROOF
- RUST PROOF

METAL PLATFORM HAND TRUCK



150 KGS



MS 115
TRIPLE DECKER SINGLE HANDLE

- 740*480*860 mm
- 130 mm
- 860 mm
- 100 mm (4")

RM 1,218



MS 201
SINGLE FOLDABLE TYPE

- 740*480*860 mm
- 150 mm
- 720 mm
- 100 mm (4")

RM 408



NB 127
DOUBLE DECKER WITH SIDE NETTING

- 740*480*860 mm
- 130 mm
- 860 mm
- 101 mm (4")

RM 1,448



300 KGS



MM 301
SINGLE FOLDABLE TYPE

- 910*610*860 mm
- 200 mm
- 860 mm
- 130 mm (5")

RM 698



500 KGS



NG401
FOLDABLE TROLLEY

- 1240*790*825 mm
- 240 mm (8")

RM 2,898

GLIDE A SIDE



WS-21GAS
2 static + 1 Movable

RM 5,038

SIZE : (W) 1830 * (D) 856 * (H) 2186 mm



WS-32GAS
3 static + 2 Movable

RM 8,388

SIZE : (W) 2745 * (D) 856 * (H) 2186 mm

SPECIFICATIONS

Material

Cold Rolled Carbon Steel (JIS G3141 SPCC - SD) & Enamel Finish for long lasting lifespan.

Pre-Treatment Process

7 stages pre-treatment process.

Powder Coating Process

The intensity of the spray will be around 50 micron to 80 micron to be sprayed to the every furniture component.

On baking side, the sprayed powdered furniture will be heated up to above 200 degree celcius to allow the powder to stick firmly to the metal component.

Body Thickness

0.8mm steel thickness after powder coated application.

Base & Track Thickness

1.2mm thickness & for track itself, there is solid steel for special bearing to move sideways left and right.

Base Loading Weight Shelf

Ability to hold 350kg per bay.
Standard UDL 65kg per shelf, able to load up to 100kg UDL upon request.

Advantage of Weeli Gas

Smoothness in moving the bay even the GAS is fully loaded.

- Smooth & stable movement.
- Office design outlook.
- Suitable for putting in any area where the room space is very limited.
- Can blend in with office area.
- UK Standard.
- 10 Years Warranty on Manufacturing Defect.



1 SET DOOR: **RM 348**



TOP ELEVATION



SIDE ELEVATION



ISOMETRIC ELEVATION

RM 1,308
* (Per bay)

SAVE 50% SPACE
* (Min order 8 bays)



Size : W1830*L4860*H2215 mm
Walkway : 800 L

WS2-20MC
20 Bays (2 Bays Deep)

- 1 Row Single Static
- 1 Row Single Movable
- 4 Row Double Movable

SPECIFICATIONS

MATERIAL
Cold Rolled Carbon Steel (JIS G3141 SPCC - SD) & Enamel Finish for long lasting lifespan.

PRE-TREATMENT PROCESS
7 stages pre-treatment process.

POWDER COATING PROCESS
The intensity of the spray will be around 50 micron to 80 micron to be sprayed to the every furniture component. On baking side, the sprayed powdered furniture will be heated up to above 200 deegree celcius to allow the powder to stick firmly to the metal component.

BODY & SHELF THICKNESS
0.8 mm steel thickness after powder coated application.

BASE & TRACK THICKNESS
2 mm thickness for the Base & for track itself, there is solid steel with 19mm thickness for the wheel to move forward & backward.
Added info - solid steel for track dimension is 32mm (W) x 19mm (H)

PLATFORM
1mm PVC laminated particle board with rough surface to prevent skid. All particle board for platform is laminated fully in all sides.

BASE LOADING WEIGHT
Ability to hold 1000kg per bay.

SHELF LOADING
Standard UDL 65kg per shelf able to load up to 100kg UDL upon request.

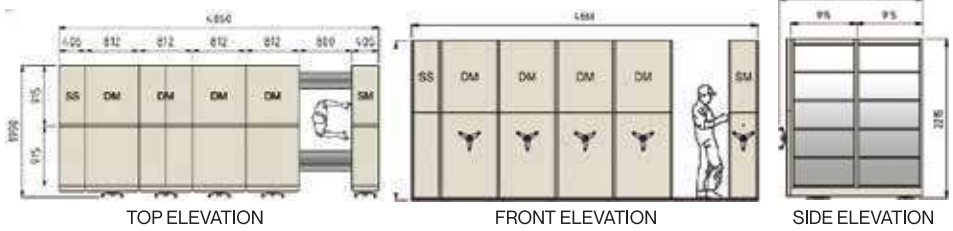

SAFETY LOCK
Lock Devise on each up stand. This is to prevent the bays moving when users retrieving the files.



- Office design outlook.
- Fully Cladding.
- No skid movement when opening up or closing in.
- Consistency rounding (Opening & Closing)
- UK standards.
- 10 years warranty on manufacturing defect.



CHAIN MECHANISM
UK Technology



SPROCKET
Heavy Duty one - Moving along the chain Track. That is the key ingredient to avoid the Wheel being worn out year after year. That is the caused having fixed no. of rotation of the Steering.



METAL WHEEL
Made by solid steel with heavy duty double bearing. This has made our wheel capability to hold the weight load of 1000kg per bay & to last longer.



SAFETY DEVISES BEARING
Anti Topple feature to prevent the bays to topple when the bays hit hard to the end of the track.



RM 999
* (Per bay)

WS1-10HC
10 Bays (1 Bay Deep)

Size : W915*L2424*H2195 mm
Walkway : 800 L

- 1 Row Single Static
- 1 Row Single Movable
- 4 Row Double Movable

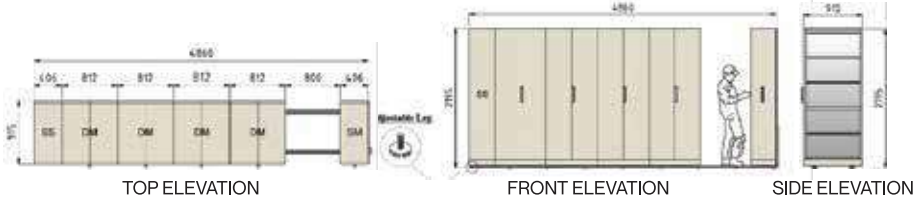

SPECIFICATIONS

MATERIAL
Cold Rolled Carbon Steel (JIS G3141 SPCC - SD) & Enamel Finish for long lasting lifespan.

PRE-TREATMENT PROCESS
7 stages pre-treatment process.

POWDER COATING PROCESS
The intensity of the spray will be around 50 micron to 80 micron to be sprayed to the every furniture component. On baking side, the sprayed powdered furniture will be heated up to above 200 deegree celcius to allow the powder to stick firmly to the metal component.

BODY & SHELF THICKNESS
0.8 mm steel thickness after powder coated application.

BASE & TRACK THICKNESS
1.5 mm thickness for base & 1.5 mm for track itself.

LOADING CAPACITY
350kg per bay.

SHELF LOADING
Standard UDL 65kg per shelf, able to load up to 100kg UDL upon request.

- Smooth movement when fully loaded.
- UK Standard.
- 10 Years Warranty on Manufacturing Defect.
- Maintenance free.

FEATURES

- Alignment mechanism which is found in the anti topple devises. This will help our compactors to continuously align when it is used.
- It can be extended to 2 bays in a row.



RM 999
* (Per bay)

WS2-20HC
20 Bays (2 Bays Deep)

Size : W1830*L2424*H2195 mm
Walkway : 800 L

- 1 Row Single Static
- 1 Row Single Movable
- 4 Row Double Movable

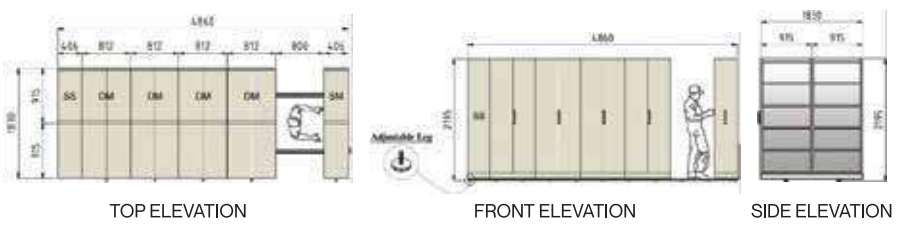

NYLON WHEEL
Nylon Wheel with heavy duty double bearing attached. This enable to have long lasting compactor & maintained smoothness.



SAFETY BEARING
Anti Topple feature to prevent the bays to topple when the bays hit hard to the end of the track



ADJUSTABLE STUB
For leveling whole compactor system.



SAFETY LOCK
Lock Devise on each up stand. This is to prevent the bays moving when users retrieving the files

OFIS MANUAL MOBILE COMPACTOR

Our Mobile Compactor Filing System are basically designed mainly for high space-saving efficiency storage system. Mainly for files, books, daily documents, stationeries and basically none high value items. Each moving row with bays can be moved on rolls for major saving in aisle space where insufficient floor space is causing major inconvenience in today's modern metropolitan. A line up of our Mobile Compactor Filing System will be able to suit your space and storage requirement.



COLOUR

- LIGHT GREY
- BEIGE

- Per Bay Measurement (Standard) : W915 x D420 x H2115 (mm)
- No. of Shelf Per Bay : With build-in lateral file holder, 4 pieces of lateral shelf
(Max Loading Capacity : 50kg per shelf)
- Material Used : - Cold rolled steel plate for the whole bay's body and shelves (0.8mm)
- Square hollow section and steel flat bar for the track & rail
- Cold rolled steel bearing and bearing base.
- Finish : Powder coating
- Locking Device : A central locking provided on the back of last single mobile bay for simple locking purposes.

ACCESSORIES



CENTRAL LOCKING BOX



LATERAL SHELF
(CAN HANG FILING POCKET)



HANDLE

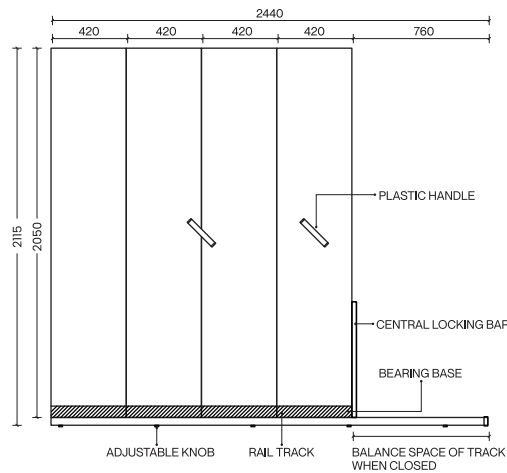
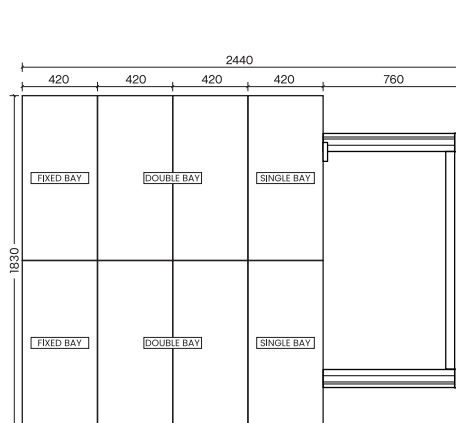

MODEL	PRODUCT DESCRIPTION	SIZE (mm)	PRICE
OF-S117/A	4 X 1 Bay Depth	W2440*D915*H2115	RM 2,688.00
OF-S117/B	6 X 1 Bay Depth	W3280*D915*H2115	RM 4,032.00
OF-S117/C	8 X 1 Bay Depth	W4120*D915*H2115	RM 5,376.00
OF-S117/D	10 X 1 Bay Depth	W4960*D915*H2115	RM 6,720.00
OF-S117/5	5 X 1 Bay Depth	W2860*D915*H2115	RM 3,470.00
OF-S117/7	7 X 1 Bay Depth	W3700*D915*H2115	RM 4,814.00
OF-S117/9	9 X 1 Bay Depth	W4540*D915*H2115	RM 6,158.00
OF-S117/12	12 X 1 Bay Depth	W5800*D915*H2115	RM 8,064.00

MODEL	PRODUCT DESCRIPTION	SIZE (mm)	PRICE
OF-S117/AD	4 X 2 Bays Depth	W2440*D1830*H2115	RM 5,376.00
OF-S117/BD	6 X 2 Bays Depth	W3280*D1830*H2115	RM 8,064.00
OF-S117/CD	8 X 2 Bays Depth	W4120*D1830*H2115	RM 10,752.00
OF-S117/DD	10 X 2 Bays Depth	W4960*D1830*H2115	RM 13,440.00
OF-S117/5D	5 X 2 Bays Depth	W2860*D1830*H2115	RM 6,940.00
OF-S117/7D	7 X 2 Bays Depth	W3700*D1830*H2115	RM 9,628.00
OF-S117/12D	12 X 2 Bays Depth	W5800*D1830*H2115	RM 16,128.00

CHOICE LOCKERS (WOODEN)



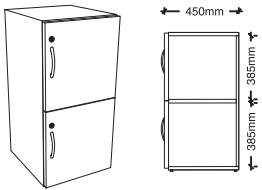
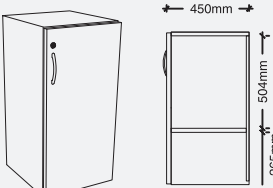
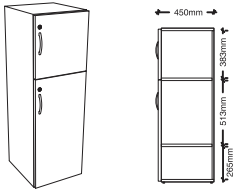
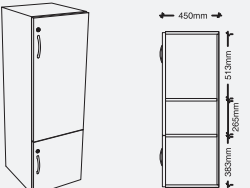
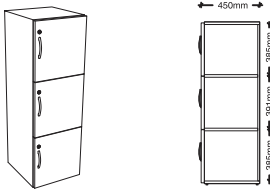



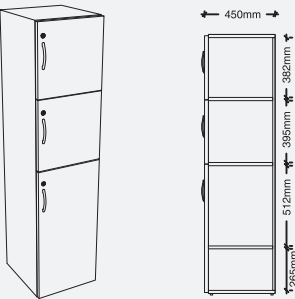
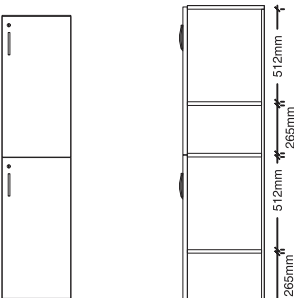
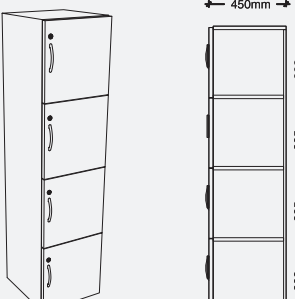
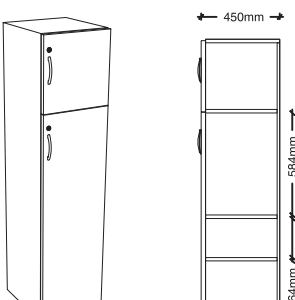



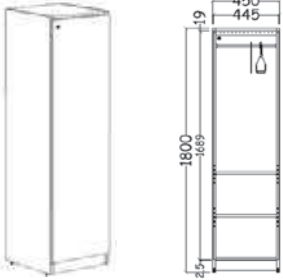
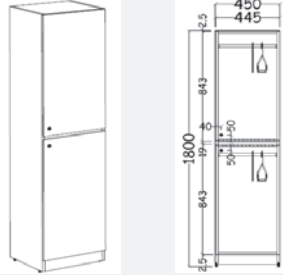

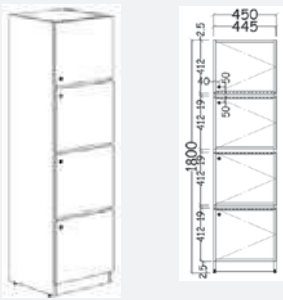











CHOICE LOCKERS			
Type		Colour	Actual (RM)
A	 <p>2DOOR Locker C/W Stopper 400 x 450 x 832mm</p>	A	318.00
		B	328.00
		C	498.00
B	 <p>1DOOR Locker C/W 1 Shelf & Stopper 400 x 450 x 832mm</p>	A	298.00
		B	308.00
		C	438.00
C	 <p>2DOOR Locker C/W 1 Shelf (BOTTOM) & Stopper 400 x 450 x 1242mm</p>	A	428.00
		B	448.00
		C	538.00
D	 <p>2DOOR Locker C/W 1 Shelf (UPPER) & Stopper 400 x 450 x 1242mm</p>	A	428.00
		B	448.00
		C	538.00
E	 <p>3DOOR Locker C/W Stopper 400 x 450 x 1242 mm</p>	A	498.00
		B	518.00
		C	558.00

CHOICE LOCKERS (WOODEN)

CHOICE LOCKERS																					
Type		Colour	Actual (RM)																		
F	 <p>3 DOOR Locker C/W 1 SHELF (BOTTOM) & Stopper 400 x 450 x 1652mm</p>	A	658.00																		
		B	678.00																		
		C	698.00																		
G	 <p>2 DOOR Locker C/W 2 Shelf & Stopper 400 x 450 x 1652mm</p>	A	578.00																		
		B	598.00																		
		C	628.00																		
H	 <p>4 DOOR Locker C/W Stopper 400 x 450 x 1652mm</p>	A	458.00																		
		B	468.00																		
		C	668.00																		
I	 <p>2 DOOR Locker C/W 2 Shelves (BOTTOM) & Stopper 400 x 450 x 1652mm</p>	A	578.00																		
		B	608.00																		
		C	638.00																		
<p>Colour A:</p> <p>Top & Door: Light Grey Bodyshelf: Dark Grey</p> <p>Colour B:</p> <p>Top & Door: Maple, Cherry, Beech Bodyshelf: Dark Grey Top, Door and Bodyshelf: White</p> <p>OR</p> <p>Colour C:</p> <p>Top, Door and Bodyshelf:</p> <table border="0"> <tr> <td>Celtic Ash</td> <td>Sonoma Oak</td> <td>Noix</td> <td>Noce</td> <td>Snow White</td> <td>Zen</td> <td>Rochelle White</td> <td>Mahogany</td> <td>Smokey</td> </tr> <tr> <td>Bavarian Beech</td> <td>Wildbirne</td> <td>Havana Oak</td> <td>Folkstone</td> <td>Tiziano Pine</td> <td>Paradisa</td> <td>Montana Cherry</td> <td>Marinus Walnut</td> <td>Ahorn Natur</td> </tr> </table>				Celtic Ash	Sonoma Oak	Noix	Noce	Snow White	Zen	Rochelle White	Mahogany	Smokey	Bavarian Beech	Wildbirne	Havana Oak	Folkstone	Tiziano Pine	Paradisa	Montana Cherry	Marinus Walnut	Ahorn Natur
Celtic Ash	Sonoma Oak	Noix	Noce	Snow White	Zen	Rochelle White	Mahogany	Smokey													
Bavarian Beech	Wildbirne	Havana Oak	Folkstone	Tiziano Pine	Paradisa	Montana Cherry	Marinus Walnut	Ahorn Natur													

CHOICE LOCKERS (WOODEN)

CHOICE LOCKERS			
Type		Colour	Actual (RM)
J	 <p>1Door Locker C/W H/ ROD & 2 SHELF & WOODEN BASE (FINGERPULL DOOR) W450 x D450 x H1800 mm</p>	A	598.00
		B	628.00
		C	708.00
K	 <p>2 DOOR Locker C/W H/ ROD & WOODEN BASE (FINGERPULL DOOR) W450 X D450 X H1800mm</p>	A	608.00
		B	648.00
		C	718.00
L	 <p>3 DOOR Locker C/W Woden Base (Finger Pull Door) W450 X D450 X H1800mm</p>	A	628.00
		B	668.00
		C	748.00
M	 <p>4 DOOR Locker C/W Wooden Base (Finger Pull Door) W400 x D450 x H1800mm</p>	A	688.00
		B	718.00
		C	798.00
<p>Colour A:  White  Ivory  Light Grey  Graphite</p> <p>Colour B:  Black  Iceland  Maple  Beech  Walnut</p> <p>Colour C:  Comfy Latte  White Oak  Warm Rovere  Ladnia  Celtic Ash  Faggiona  Life Oak  Acacia  Shimo Ash</p>			
<p>OPTION LOCK</p>  <p>Numbering Lock + RM 35.00 per lock</p>	 <p>Digital Lock + RM 120.00 per lock Only for Type J-M</p>		



MODEL 9079 CALL FOR BEST PRICE

Standard configuration description

1. Armrests, chair legs, fasteners: Made of aluminum alloy materials, large precision casting molds, polished directly after die-casting, and treated with electrostatic powder spraying.
2. Seat plate and back plate material: high-density polyurethane (PU) (inner steel plate) molding, seat plate and back plate are one-piece structure.
3. Cross beam: Made of 40*80mm rectangular steel pipe, 2.5mm thick, thick structure, electrostatic powder spraying treatment on the surface, good bearing capacity, beautiful appearance, smooth surface, no need to reserve openings for fixed structures on the cross beam.



MODEL 9077 CALL FOR BEST PRICE

Optional armrest / leg 1 : With cold-roll steel, metal paint, sparyed static powder after polishing and antirust treatment.

Optional armrest / leg 2 : Die-casting aluminium alloy with polishing treatment and sparyed with static powder.

Seat, back : High density PU with metal frame inside.

Beam : Use high-quality triangular steel tube, sparyed with air-conditioning outdoor paint powder, strong safety performance



MODEL SJ 708 PU CALL FOR BEST PRICE

Seat, back : With 1.5mm high quality cold-rolled steel plate, static powder after antirust treatment, cold consolidation foam forming of high density PU and high quality steel frame inside.

Beam : Use high quality triangular steel tube, sprayed with airconditioning outdoor paint powder, strong safety performance.

Armrest, leg, bracket : Die-casting aluminium alloy with polish treatment and sprayed with static powder.

Colour Option :

- SJ-FPU01 Black
- SJ-FPU02 Dinggray
- SJ-FPU03 Sky Blue
- SJ-FPU04 Blue
- SJ-FPU05 Bright Green
- SJ-FPU06 Dark red
- SJ-FPU07 Magenta
- SJ-FPU09 Apple Green
- SJ-FPU10 Grey
- SJ-FPU11 Orange
- SJ-FPU12 BROWN

SJAC820 & SJAC820A



Armrest / leg : Using high quality imported cold-rolled steel, with electroplating chrome treatment.

Seat / back : High quality imported cold-rolled steel sprayed with static powder after antivirus treatment.

Beam : High-quality metal tube, sprayed with static powder after antivirus treatment.

MODEL	DESCRIPTION	SIZE (mm)	PRICE
OF-SJAC820-2	2 SEATER LINK CHAIR SILVER	L1180 x D660 x H770	RM 398
OF-SJAC820-3	3 SEATER LINK CHAIR SILVER	L1750 x D660 x H770	RM 438
OF-SJAC820-4	4 SEATER LINK CHAIR SILVER	L2320 x D680 x H770	RM 598
OF-SJAC820-5	5 SEATER LINK CHAIR SILVER	L2890 x D680 x H770	RM 798

MODEL	DESCRIPTION	SIZE (mm)	PRICE
OF-SJAC820A-2	2 SEATER LINK CHAIR (PVC PADED)	L1180 x D660 x H770	RM 518
OF-SJAC820A-3	3 SEATER LINK CHAIR (PVC PADED)	L1750 x D660 x H770	RM 638
OF-SJAC820A-4	4 SEATER LINK CHAIR (PVC PADED)	L2320 x D680 x H770	RM 858
OF-SJAC820A-5	5 SEATER LINK CHAIR (PVC PADED)	L2890 x D680 x H770	RM 1,118

• Images provided are for illustration purposes only. • Prices quoted are subject to change without prior notice & while stocks last. • Terms & conditions apply. • While every care is taken in the preparation of this flyer any inaccuracy or omission is much regretted.

PUBLIC SEATING SERIES

PLASTIC | FABRIC LINK CHAIR & BENCHES



PLASTIC LINK CHAIR



OF-3020-2 | OF-3020-3 | OF-3020-4
 RM 388 RM 548 RM 718



OF-3000-2 | OF-3000-3 | OF-3000-4
 RM 358 RM 488 RM 578



OF-3140-2 | OF-3140-3 | OF-3140-4
 RM 388 RM 568 RM 718

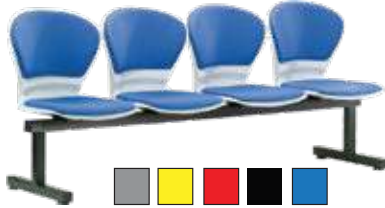

OF-3030-2 | OF-3030-3 | OF-3030-4
 RM 548 RM 768 RM 998



OF-850-2 | OF-850-3 | OF-850-4
 RM 368 RM 498 RM 658



OF-3040-2 | OF-3040-3 | OF-3040-4
 RM 398 RM 498 RM 598



OF-SJAC8207-3
 3 Seater (Black only)
 W1800*D660*H780
 RM 468



OF-MAIA-3
 3 Seater
 L1500*W460*H910
 RM 708



OF-BRIZ-3
 3 Seater
 L1500*W460*H910
 RM 608



OF-SJAC8202
 3 Seater L1500*W490*H390 RM 288
 4 Seater L2020*W490*H390 RM 368



*For projects only
OUTDOOR BENCH
 L1700*W450*H450
CALL FOR BEST PRICE

FABRIC LINK CHAIR



OF-3010-2 | OF-3010-3 | OF-3010-4
 RM 438 RM 578 RM 788



OF-820-2 | OF-820-3 | OF-820-4
 RM 498 RM 668 RM 998



OF-830-2 | OF-830-3 | OF-830-4
 RM 698 RM 998 RM 1,328



OF-3110-2 | OF-3110-3 | OF-3110-4
 RM 918 RM 1,298 RM 1,888



OF-3100-2 | OF-3100-3 | OF-3100-4
 RM 828 RM 1,208 RM 1,838



OF-3120-2 | OF-3120-3 | OF-3120-4
 RM 718 RM 1,018 RM 1,358

BENCH



B-100S
 L1250*W453*H453 mm
 RM 2,998



B-200S
 L1250*W651*H893 mm
 RM 4,538



B-300EG
 L1250/1550/1850*W665*H910 mm
 RM 3,118 (L1250) RM 3,488 (L1550) RM 3,778 (L1850)



B-900SW
 L1750*W550*H520 mm
 RM 3,698



WK-WB18
 L1500*W457*H457 mm
 RM 718



B-400EG
 L1250/1550/1850*W465*H625 mm
 RM1,558 (L1250) RM 1,698 (L1550) RM 1,828 (L1850)



B-500EG
 L1250/1550/1850*W665*H910 mm
 RM2,958 (L1250) RM 3,308 (L1550) RM 3,598 (L1850)



B-800EG
 L1250/1550/1850*W665*H540 mm
 RM1,478 (L1250) RM 1,658 (L1550) RM 1,758 (L1850)



OF-RWB
 L1200*W450*H450 mm
 RM 448



CH-BS18
 L1500*W457*H457 mm
 RM 978

MODERN TRAINING ROOM SEATING



APTO SERIES

Call for BEST PRICE

Back Mesh



Seat



1. PP PLASTIC BACK

Except mesh back, the back is made of pp plastic, high quality PP material is easy to clean, highly recommended for use in hospital.

2. MESH BACK

Promoted greater ventilation and it could be allows air to flow freely to reach the back, contoured shape provided superior comfort.

3. ALUMINIUM BACK MECHANISM

Aluminium back mechanism can be tilt 12 degrees which allows user to stretch their back.

4. POLYURETHANE MOULDED FOAM

High density polyurethane moulded foam gives the seat flexibility to make the user comfortable, provides great support and best comfort even for long seating hours.

5. POWDER PAINTED & NESTED FRAME

Solid, safe and stable steel base provides strong stability with powder painted frame. The frame also can be nested to saving storage space.

6. GLIDE

Glides are suitable for fixed position.

7. CASTORS

Dual-wheel PU castors are designed for easy manoeuvring.



M35P-C

W665 * D685 * H845 mm

8. SLIDING PP ARMPAD

The pad can be slid forward and backward to firmly support elbows.

9. FOLDABLE WRITING TABLE

The foldable writing board size is 365mm x 285mm x 21mm thick, making the documentation process easier for user. (Maximum loading of writing table are 90kg).

10. LINKING BRACKET (OPTIONAL)

Designed linking bracket to link chairs together.

11. STORAGE BASKET (OPTIONAL)

Storage basket underneath the seat for use in the training room and classroom.



M35P-C

W630 * D610 * H845 mm

M35-TG

W665 * D685 * H845 mm

M35-G

W630 * D570 * H845 mm

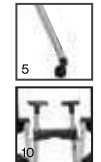

CLAVO SERIES

Call for BEST PRICE

Back Mesh



Seat



Easy to fold, stackable & space saving



OF-CH-CLA-TG(C)
W720 * D620 * H820 mm



OF-CH-CLA-G(C)
W590 * D620 * H820 mm



OF-CH-CLA-TC
W720 * D620 * H820 mm



OF-CH-CLA-C
W590 * D620 * H820 mm



GAP SERIES

Call for BEST PRICE

Back Rest Polypropylene (PP Frame)

Seat



GAP-TC
W600 * D590 * H840 mm



GAP-C
W580 * D590 * H840 mm



GAP-TG
W600 * D590 * H840 mm



GAP-G
W580 * D590 * H840 mm



90° flippable seat for compact storage



Flippable armrest



Durable quality of aluminium joints with rubber padding protection

HUBB SERIES

Back Rest



CHAIR FEATURES



OF-CH-HUBB-T
W600 * D540 * H840 mm
RM 298



OF-CH-HUBB
W570 * D540 * H840 mm
RM 278



Seat pad in PU moulded foam



90° flippable seat for compact storage



Durable quality of aluminium joints

TRAINING DESK SERIES



ACACIA
SERIES



Depth : 600 * Height : 750	
Width : 900	RM 688
1200	RM 728
1500	RM 798
1800	RM 868



Wiring conduct available for power & data requirement.



The duct can be accessed from the top of the leg and cables can be brought out at the bottom of the leg

Designed for elegance & use convenience

TOP COLOUR :



FRAME COLOUR :



FLICK
SERIES



Easy Rotate and Fold

Depth : 600 * Height : 750	
Width : 1200	RM 528
1500	RM 598
1800	RM 698



* 1.5mm cold rolled steel, powder coating



Lockable Roller

* 2.5" PU castor

COLOUR OPTION :



FLICK II
SERIES



Easy to fold, move and store.



Flip-up cover for wire trunking.



Large and easy to hold handles.

Frame with colour choices :



Depth : 600 * Height : 750	
Width : 1200	RM 848
1500	RM 948
1800	RM 998

COLOUR OPTION :

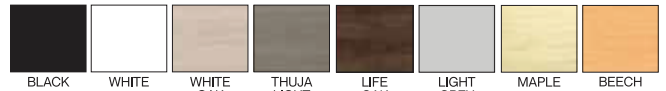

KNOX
SERIES



ROTATE LOCKING SYSTEM

A simple step release enables turn left and right knob to flip and lock the top



Depth : 600 * Height : 750	
Width : 1200	RM 528
1500	RM 598
1800	RM 698

- **KNOX 126**
1200 x 600 x 750MM
- **KNOX 156**
1500 x 600 x 750MM
- **KNOX 186**
1800 x 600 x 750MM



BANQUET SERIES

FOLDABLE RECTANGULAR TABLE (OPTION 1)

ITEM	SIZE (W*D*H)	GREY	DG-CHERRY / DG MAPLE	DG-BEECH / FULL WHITE
FT 2515 N	750*450*760	RM 135	RM 140	RM 160
FT 315 N	900*450*760	RM 145	RM 150	RM 165
FT 415 N	1200*450*760	RM 130	RM 160	RM 180
FT 515 N	1500*450*760	RM 140	RM 180	RM 190
FT 615 N	1800*450*760	RM 150	RM 195	RM 205
FT-2520 N	750*600*760	RM 145	RM 150	RM 170
FT-320 N	900*600*760	RM 155	RM 160	RM 180
FT-420 N	1200*600*760	RM 140	RM 175	RM 190
FT 520 N	1500*600*760	RM 150	RM 195	RM 215
FT 620 N	1800*600*760	RM 160	RM 215	RM 235
FT 2525 N	750*750*760	RM 160	RM 165	RM 180
FT 325 N	900*750*760	RM 180	RM 185	RM 195
FT 425 N	1200*750*760	RM 195	RM 200	RM 210
FT 525 N	1500*750*760	RM 220	RM 225	RM 245
FT 625 N	1800*750*760	RM 240	RM 245	RM 270
FT 630 N	1800*900*760	RM 260	RM 270	RM 340



RECTANGULAR BANQUET TABLE



HALF ROUND BANQUET TABLE



ROUND BANQUET TABLE



TABLE CURTAIN



QUARTER BANQUET TABLE



CRESCENT BANQUET TABLE



ROUND TABLE TROLLEY



RECTANGULAR TABLE TROLLEY



SKIRTING CLIP



TR-BQ28

TOP SURFACE : 16 mm thick melamine laminated chipboard
EDGING : 2 mm thick ABS flatted in DARK GREY colour

METAL LEG :
 OPTION 1 : 25 mm x 25 mm mild steel square table with folding mechanism and adjustable stub in BLACK EPOXY coated
 OPTION 2 : 32 mm x 32 mm mild steel square table with folding mechanism and adjustable stub in BLACK EPOXY coated

CALL FOR BEST PRICE

PLASTIC TOP FOLDABLE BANQUET TABLE



BQT-1220
L1220 X W610 X H740 MM **RM 188**
BQT-1520
L1520 X D760 X H740 **RM 228**
BQT-1830
L1830 X D760 X H740 **RM 268**

BQT-1220F
L1200 X W600 X H740 MM **RM 178**
BQT-1520F
L1520 X W700 X H740 MM **RM 228**
BQT-1220R
R1220 X H740 MM **RM 328**

BQT-1220R
R1220*H740 MM **RM 328**
BQT-1520R
R1520*H740 MM **RM 508**

BQT-1220RF
R1220 X H740 **RM 318**
BQT-1520RF
R1520 X H740 **RM 488**
BQT-1830RF
R1830 X H740 **RM 648**

BANQUET CHAIR

BLUE & MAROON ONLY NORMAL SPONGE

MODEL	EPOXY BLACK	EPOXY WHITE / GOLD / SILVER	CHROME
OF-BC-9006	RM 82	RM 98	RM 115
OF-BC-9007	RM 100	RM 108	RM 128
OF-BC-9005	RM 118	RM 125	RM 145

BLUE & MAROON ONLY SEAT PU FOAM

MODEL	EPOXY BLACK	EPOXY WHITE / GOLD / SILVER	CHROME
OF-BC-9006	RM 107	RM 123	RM 140
OF-BC-9007	RM 125	RM 133	RM 153
OF-BC-9005	RM 143	RM 150	RM 170



BANQUET CHAIR TROLLEY



*Images provided are for illustration purposes only. *Prices quoted are subject to change without prior notice & while stocks last. *Terms & conditions apply. *While every care is taken in the preparation of this flyer any inaccuracy or omission is much regretted.

DESIGN CHAIR

THE NEXT LEVEL
X TREME
COLOUR OPTION :



CARMEL SERIES



CMLS 912F - AB17EC
W560*H845MM
Designer Chair
4 Prong Aluminium Base

RM 738



CMLS 912F - AB17E
W440*H845MM
Designer Chair
4 Prong Aluminium Base

RM 738



CMLS 9114F - 48E
W560*H70MM
Conference Chair
Dining Steel Base

RM 558

RAY SERIES



RYLS 9914F - 45E
W500*H790MM
Conference Chair
With Seat Pad

RM 378



RYLS 9915F - 41E
W400*H790MM
Conference Chair
With Seat Pad

RM 378



RYLS 9914 - 45E
W530*H790MM
Conference Chair
Without Seat Pad

RM 298



RYLS 9914 - 45E
W530*H790MM
Conference Chair
Without Seat Pad

RM 298

AUNTHUR SERIES



ATLS 9212F - AB17EC
W550*H730MM
Designer Chair
4 Prong Full Aluminium Base

RM 708



ATLS 9212F - AB17E
W550*H730MM
Designer Chair
4 Prong Full Aluminium Base

RM 718



ATLS 9213F - 50W
W550*H730MM
Armchair
Full Solid Wood Base

RM 658



ATLS 9214F - 47E
W450*H730MM
Armchair
Dining Steel Based Dining Steel Base

RM 538

VAST SERIES



VLSL 9312F - AB17EC
W620*H780MM
Presidential High Back
4 Prong Aluminium Base

RM 628



VLSL 9312F - AB17E
W416*H780MM
Presidential High Back
4 Prong Aluminium Base

RM 628



VLSL 9314F - 47E
W620*H780MM
Presidential Medium Back
Dining Steel Base

RM 458



VLSL 9315F - 40E
W620*H780MM
Presidential High Back
Cantilever Steel Base

RM 438

CAFE SERIES FIBREGLASS

WHY CHOOSE FIBRE GLASS TABLE TOP ?

Fibreglass is a composite material comprising a polymer matrix reinforced with fiber and is commonly used in many sectors.



AK 400
W1425 x D535 x H765



AK 401
W1016 x D1350 x H765



AK-149
W406 x D406 x H914



AK-153
W1524 x D610 x H760



AK 404
W1425 x D1070 x H765



AK-150
W915 x D915 x H760



AK 603
W1550 x D1800 x H765



AK 608
W1800 x D1350 x H765



AK 802
W2400 x D1350 x H765



AK 808
W2400 x D1350 x H765



AK 605



AK 402
W1200 x D1350 x H765



AK 606
W2000 x D2000 x H765



AK 602
W1800 x D1350 x H765



AK 607
W1800 x D1350 x H765



AK-152
W1016 x D610 x H760



AK-151
W915 x D915 x H760

COLOURS



CAFE SERIES HIGH / LOW BAR STOOL



BC 787
● ○ ●
RM 228



BS-MODENO
RM 248



OF-BS-EVEBAR
RM 288



OF-BS-VENICE
○ ●
RM 168



OF-BS-TYRA
● ●
RM 308



OF-PF-32-7
RM 268



OF-BS-CHG MYCHAIR
RM 138



OF-BS-115
● ○ ●
RM 118



OF-DBC141B
● ●
RM 398



OF-DBC143
● ●
RM 398



BAR 750
● ○ ●
RM 218



OF-BS-ROBAR
○ ●
RM 168



OF-BC155B
● ●
RM 398



OF-BC159B
● ●
RM 398



OF-BC STOCKHOLM
● ●
RM 468



OF-BC26
● ●
RM 358



OF-BC877
● ● ●
RM 298



OF-BC832
● ● ●
RM 288



OF-BC BERLIN
● ● ●
RM 288



OF-DBC LISBON
RM 688



OF-DS60
●
RM 148



OF-DS3301
●
RM 78



OF-DS NARA
●
RM 108



OF-DS MORI
● ● ●
RM 148



OF-DS24
● ● ●
RM 108



OF-NS600
●
RM 108



OF-SQ600
●
RM 108



OF-DSQ18
● ●
RM 98



OF-DS18(N)
● ●
RM 118



BS750
○ ● ● ●
RM 188



OF-BS-TRYA
● ●
RM 298



OF-BC-MONACO
○ ●
RM 288



SPM-C5
RM 218



BC799
○ ●
RM 183



OF-BS-LOBAX
○ ●
RM 158



TABLE SET c/w TAURUS BAR STOOL
1 High Table + 4 High Bar Chairs
W1200*D600*H1050 **RM 1,288 / SET**

TABLES SERIES



DT880R
Ø900*H760
RM 428



DT-90R
Ø900*H760
RM 308



DT 118
Ø800*H740
RM 318



***IT-232**
L600*W600*H1030
RM 518



***IT-280**
L800*W800*H740
RM 408



Z206
L1200*W700*H750
RM 338



Z230-SQ
L800*W800*H750
RM 298



PTRT160WH
L1600*W1000*H740
RM 638











































Z231
L800*W800*H730
RM 308

CAFE SERIES

WOODEN/CUSHION CHAIR SERIES



- | | | | | | | |
|---|--|--|---|---|--|---|
|  <p>OF-DC8581
RM 318</p> |  <p>DC2902
RM 348</p> |  <p>DC 673
RM 218</p> |  <p>DC 1906
RM 238</p> |  <p>DC SANTO
RM 238</p> |  <p>DC CREEK
RM 348</p> |  <p>DC8894
RM 288</p> |
|  <p>DC727
RM 148</p> |  <p>DC9685
RM 188</p> |  <p>DC TARA
RM 148</p> |  <p>DC VERA
RM 338</p> |  <p>DC8576
RM 298</p> |  <p>DC8572
RM 258</p> |  <p>DC KYOTO
RM 298</p> |
|  <p>DC8896
RM 248</p> |  <p>DC8300
RM 178</p> |  <p>DC1902 (FB)
RM 248</p> |  <p>DC 737
RM 148</p> |  <p>DC1903
RM 268</p> |  <p>DC98
RM 228</p> |  <p>DC162
RM 518</p> |
|  <p>DC172
RM 398</p> |  <p>DC178
RM 518</p> |  <p>DC174
RM 408</p> |  <p>DC159
RM 398</p> |  <p>DC155
RM 398</p> |  <p>OF-DC218
RM 198</p> |  <p>DC1902
RM 248</p> |
|  <p>DC RATTAN
RM 268</p> |  <p>DC RATTAN
RM 268</p> |  <p>DC CASSINA
RM 338</p> |  <p>DC CANE
RM 388</p> |  <p>DC HANOI
RM 688</p> |  <p>DC LISBON
RM 758</p> | |
|  <p>PC DHAKA
RM 258</p> |  <p>DC142
RM 538</p> |  <p>DC143
RM 538</p> |  <p>DC144
RM 408</p> |  <p>DC2000
RM 188</p> |  <p>DC2001
RM 188</p> | |

CAFE SERIES

POLYPROPYLENE SERIES



 <p>#OF-P111S + PLP01 ●●● RM 118</p>	 <p>#M-505 ○●●● RM 338</p>	 <p>#OF-TM 866 ●●● RM 128</p>	 <p>#OF-151 ●●● RM 128</p>	 <p>#OF-TM 868 ●●● RM 128</p>	 <p>#DC-423 ●○ RM 78</p>	 <p>#A648 ●●●○ RM 158</p>	
 <p>#OF-TM 869 ●●● RM 128</p>	 <p>#M-905 ● RM 198</p>	 <p>OF-P1672 ●●● RM 35</p>	 <p>#OF-P121 ●●● RM 170</p>	 <p>OF-PP801 ○●●●● RM 158</p>	 <p>OF-SYLVIA ●●● RM 178</p>	 <p>#A649C ●○ RM 178</p>	
 <p>OF-FCA 2676 ● RM 42</p>	 <p>*OF-P131 ○●●● RM 128</p>	 <p>#OF-P132 ●●● RM 98</p>	 <p>#OF-M901 ●●● RM 318</p>	 <p>OF-STELLA ○●●●● RM 98</p>	 <p>OF-VINCI ○●●●● RM 98</p>	 <p>OF-Z-02 ○●●●● RM 75</p>	
 <p>OF-2446 ○●●● RM 125</p>	 <p>OF-2445 ○●●● RM 125</p>	 <p>#OF-P144 ○●●● RM 98</p>	 <p>OF-EZ 701 ●●● RM 48</p>	 <p>OF-FCA 1758 ○●●●● RM 128</p>	 <p>*IC-219 ●●● RM 228</p>	 <p>*OF-DC 63 (N) ●● RM 408</p>	
 <p>*OF-DC 08 ●● RM 358</p>	 <p>OF-SB 701 ○●●● RM 78</p>	 <p>OF-Z-03 ●●● RM 78</p>	 <p>#OF-P112 + PLP02 ○●● RM 128</p>	 <p>*OF-DC-STOCKHOLM ●● RM 390</p>	 <p>*OF-DC-STOCKHOLM (A) ●● RM 410</p>		
 <p>OF-IZ 701 ○●●● RM 78</p>	 <p>#OF-P142 ○●●● RM 118</p>	 <p>OF-MB 701 ○●●● RM 48</p>	 <p>OF-Z04 ○●●● RM 78</p>	 <p>OF-EL 701 ○●●●● RM 48</p>	 <p>*OF-K 220 ●●● RM 228</p>	 <p>*OF-DC MILAN ● RM 168</p>	 <p>OF-2276 ○●●● RM 125</p>

CAFE SERIES MIX & MATCH

CREATE YOUR OWN TABLE

Put your imagination to the mix-and-match fun with a wide selection of tabletops and table legs. The wide variety of colours, shapes, materials and sizes of tabletops provide solutions for impressive dining environment, thanks to the ease of combination and long-lasting characteristics of material.

PORCELAIN TOP (37MM)

Porcelain tiles have an extremely low level of water absorption and are perfect for spaces that occasionally get damp. They are harder, stronger, and more durable than any natural stone - ever granite and have superior chip resistance. Porcelain tiles are among the most hygienic building materials, completely free of moisture and inhospitable for the growth of bacteria of all kinds. With no surface glaze to wear through, the tile's appearance will stay the same for the life of the tile.



TOP SIZE (MM)	PRICE
DIA 600	RM 578
DIA 750	RM 768
DIA 900	RM 978
L600*W600	RM 518
L750*W750	RM 748
L900*W900	RM 908

SMART TOP (HPL)(16MM THK)

SPECIFICATION

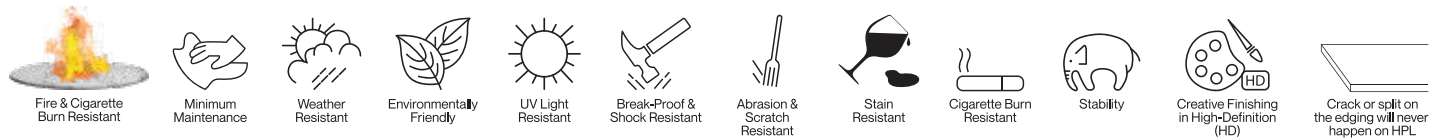

SMART TOP COLOUR



TOP SIZE (MM)	PRICE
DIA 600	RM 130
DIA 800	RM 188
DIA 915	RM 220
DIA 1270	RM 470

TOP SIZE (MM)	PRICE
L600*W600	RM 145
L700*W700	RM 150
L800*W800	RM 188
L915*W915	RM 215

TOP SIZE (MM)	PRICE
L1200*W700	RM 265
L1350*W800	RM 390
L1600*W900	RM 585

QUARTZ STONE (17MM THK)

QUARTZ STONE COLOUR

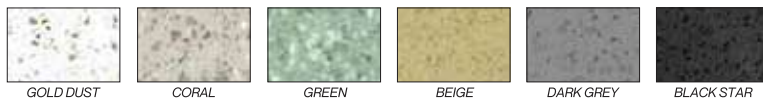

TOP SIZE (MM)	PRICE
DIA 600	RM 245
DIA 900	RM 498
DIA 1050	RM 668
DIA 1200	RM 868
L600*W600	RM 245

TOP SIZE (MM)	PRICE
L900*W900	RM 498
L1200*W750	RM 548
L1500*W900	RM 818
L1800*W900	RM 978

COMPRESSED MARBLE (17MM THK)

COMPRESSED MARBLE COLOUR

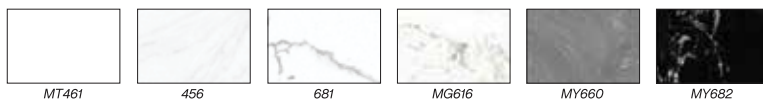

TOP SIZE (MM)	PRICE
DIA 600	RM 200
DIA 900	RM 398
DIA 1050	RM 528
DIA 1200	RM 658
L600*W600	RM 200

TOP SIZE (MM)	PRICE
L900*W900	RM 398
L1200*W750	RM 428
L1500*W900	RM 628
L1800*W900	RM 748

RUBBER WOOD (18MM THK)

RUBBER WOOD COLOUR



TOP SIZE (MM)	PRICE
DIA 600	RM 155
DIA 750	RM 230
L600*W600	RM 155

TOP SIZE (MM)	PRICE
L750*W750	RM 230
L1200*W750	RM 330

LAMINATION BOARD (HPL)(25MM THK)

LAMINATION BOARD (HPL) COLOUR



TOP SIZE (MM)	PRICE
DIA 600	RM 235
DIA 800	RM 435
DIA 900	RM 515
L600*W600	RM 185

TOP SIZE (MM)	PRICE
L800*W800	RM 360
L900*W900	RM 430
L1200*W600	RM 345
L1200*W750	RM 480

MOISTURE RESISTANT TOP (16MM THK)

MOISTURE RESISTANT TOP COLOUR



TOP SIZE (MM)	PRICE
DIA 600	RM 130
DIA 750	RM 170
DIA 900	RM 200
DIA 1200	RM 360
L600*W600	RM 130
L750*W750	RM 170
L900*W900	RM 200

TOP SIZE (MM)	PRICE
L1200*W750	RM 175
L1500*W750	RM 285
L1800*W750	RM 320
L1500*W900	RM 300
L1800*W900	RM 320
L2400*W900	RM 420

MELAMINE TOP (CHAMFER EDGING)(25MM THK)

Melamine is a popular, budget friendly and durable material that is highly resistant to scratches. Melamine tops have a higher screw holding capacity and are preferred for furniture that can be assembled with screws. The material also has a high resistance to oils and mild acids and can withstand heat to a great extent as well. Melamine is also less prone to staining and relatively cheaper than stone or porcelain.

MELAMINE TOP COLOUR



TOP SIZE (MM)	PRICE
DIA 580	RM 160
DIA 730	RM 220
DIA 880	RM 295
L580*W580	RM 160
L730*W730	RM 220
L880*W880	RM 295

MELAMINE TOP (25MM THK)

MELAMINE TOP COLOUR



TOP SIZE (MM)	PRICE
DIA 600	RM 110
DIA 750	RM 155
DIA 900	RM 185
DIA 1200	RM 290
L600*W600	RM 110
L750*W750	RM 155
L900*W900	RM 185

TOP SIZE (MM)	PRICE
L1200*W750	RM 160
L1500*W750	RM 255
L1800*W750	RM 280
L1500*W900	RM 260
L1800*W900	RM 285
L2400*W900	RM 300

STAINLESS STEEL BASE

ALUMINIUM BASE



TL-450R375



TL-500R375



TL-450R575



TL-500R575



TL-450R705



TL-500R705



TL-AB17H720



TL-AB17H865



TL-450R975



TL-500R975



TL-450R705S



TL-760R705S



TL-180R705



TL-180R975



TL-AB19H600



TL-AB19H720

EPOXY STEEL BASE



TL-MLQ(S)



TL-MLQ



TL-MLO(S)



TL-MLO



TL-ML FLIP



TL-MLX 2



TL-MLX(S)



TL-MLX(M/X)



TL-MLR(S)



TL-MLR(M)



TL-MLR(X)



TL-MLR2



TL-MPLR



TL-MPLR2



TL-MPLX



TL-MPLQ



TL-013-2(L)



TL-401(L)



TL-407(L)



TL-413(L)



TL-012(L)



TL-MPL139

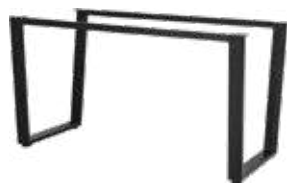

TL-MLG / TL-MPLG



TL-ML139



TL-MLI(S)



TL-MLA

MODEL	HEIGHT	TOP SIZE (MM)	PRICE
TL-450R375	375 MM	DIA 600/750, 600*600, 750*750	RM 468
TL-500R375	375 MM	DIA 750/900, 750*750, 900*900	RM 515
TL-450R575	575 MM	DIA 600/750, 600*600, 750*750	RM 440
TL-500R575	575 MM	DIA 750/900, 750*750, 900*900	RM 486
TL-450R705	705 MM	DIA 600/750, 600*600, 750*750	RM 486
TL-500R705	705 MM	DIA 750/900, 750*750, 900*900	RM 534
TL-450R975	975 MM	DIA 600/750, 600*600, 750*750	RM 523
TL-500R975	975 MM	DIA 750/900, 750*750, 900*900	RM 570
TL-450R705S	705 MM	DIA 750/900, 750*750, 900*900	RM 486
TL-760R705S	705 MM	(L)1200/1500*(D)600/800	RM 735
TL-180R705	705 MM	NIL	RM 275
TL-180R975	975 MM	NIL	RM 314
TL-AB17H720	720 MM	DIA 600/750, 600*600, 750*750	RM 440
TL-AB17H865	865 MM	DIA 600/750, 600*600, 750*750	RM 460
TL-AB19H600	600 MM	DIA 600/750, 600*600, 750*750	RM 385
TL-AB19H720	720 MM	DIA 600/750, 600*600, 750*750	RM 405
TL-401	725 MM	DIA 600/700/900, 600*600, 750*750, 900*900	RM 78
TL-407	725 MM	DIA 600/700/900, 600*600, 750*750, 900*900	RM 118
TL-413	725 MM	DIA 600/700/900, 600*600, 750*750, 900*900	RM 128
TL-013-2	1020 MM	DIA 600/750, 600*600, 750*750	RM 148
TL-012	725 MM	DIA 600/700/900, 600*600, 750*750, 900*900	RM 198
TL-MLQ(S)	725 MM	DIA 600/750, 600*600, 750*750	RM 250
TL-MLQ	725 MM	DIA 900, 900*900, REC (W)1200*(D)750	RM 300
TL-MLO(S)	710 MM	DIA 600/750/800, 600*600, 750*750, 800*800	RM 600
TL-MLO	710 MM	DIA 900/1200, 900*900, 1200*1200, REC (W)1200*(D)750	RM 630
TL-MLX(S)	725 MM	DIA 600/750, 600*600, 750*750	RM 170
TL-MLX(M/X)	725 MM	DIA 900/1200, 900*900, 1200*1200, REC (W)1200*(D)750	RM 240

MODEL	HEIGHT	TOP SIZE (MM)	PRICE
TL-MLX 2	730 MM	DIA 1200, 1200*1200, REC (W)1200*(D)750	RM 289
TL-ML FLIP	730 MM	DIA 600/750/800, 600*600, 750*750, 800*800	RM 406
TL-MLR(S)	725 MM	DIA 600/750, 600*600, 750*750	RM 290
TL-MLR(M)	725 MM	DIA 900, 900*900	RM 350
TL-MLR(X)	725 MM	(L)1000/1200*(D)600/750	RM 410
TL-MLR2	730 MM	(L)1200/1600*(D)600/900	RM 550
TL-MLG(S)	725 MM	(L)1200*(D)600/800	RM 490
TL-MLG(M)	725 MM	(L)1500/1600*(D)900	RM 500
TL-MLG(X)	725 MM	(L)1800*(D)900	RM 530
TL-ML139(S)	725 MM	(L)1200*(D)600/800	RM 280
TL-ML139(M)	725 MM	(L)1500/1600*(D)900	RM 300
TL-ML139(X)	725 MM	(L)1800*(D)900	RM 325
TL-MLI(S)	725 MM	(L)1200*(D)600/800	RM 190
TL-MLI(M)	725 MM	(L)1500/1600*(D)900	RM 200
TL-MLI(X)	725 MM	(L)1800*(D)900	RM 240
TL-MLA	730 MM	(L)1200/1600*(D)600/900	RM 300
TL-MPLG(S)	1025 MM	(L)1200*(D)600/700	RM 525
TL-MPLG(M)	1025 MM	(L)1500/1600*(D)600/700	RM 540
TL-MPLG(X)	1025 MM	(L)1800*(D)600/700	RM 585
TL-MPL139(S)	1025 MM	(L)1200*(D)600/700	RM 340
TL-MPL139(M)	1025 MM	(L)1500/1600*(D)600/700	RM 410
TL-MPL139(X)	1025 MM	(L)1800*(D)600/700	RM 430
TL-MPLX	1025 MM	DIA 600/750/800, 600*600, 750*750, 800*800	RM 210
TL-MPLQ	1025 MM	DIA 600/750/800, 600*600, 750*750, 800*800	RM 240
TL-MPLR	1025 MM	DIA 600/750/800, 600*600, 750*750, 800*800	RM 295
TL-MPLR2	1030 MM	(L)1200/1600*(D)600/900	RM 570

EDUCATION SERIES COMPUTER TABLE / STUDY TABLE



CT-62
Computer Table
W800*D450*H750
RM 228



CT-68
Computer Table
W750*D600*H750
RM 278



CT-98
Computer Table
W1050*D600*H750
RM 308



CT-100
Computer Table
W1200*D600*H750
RM 588



OF-CT-200
Computer Table
W1050*D600*H750
RM 328



OF-CT-300
Computer Table
W1200*D600*H750
RM 378



CT-20
Computer Table
W1800*D750*H740
RM 1,128



OF-WST0001
Study Table
W700*D500*H760
RM 155



OF-WST0005
Study Table
W700*D500*H760
RM 195



OF-WST0006
Study Table c/w Drawer
W700*D500*H760
RM 238



OF-WST0011
Study Table c/w Drawer
W700*D500*H760
RM 210



OF-WST0014
Study Table c/w Drawer
W700*D500*H760
RM 238



OF-SC0135
Study Correl
W915*D610*H1370
RM 538



OF-SC0316
Study Correl
W915*D610*H1370
RM 838



OF-SMK5
Study Table
W620*D400*H760
RM 165



OF-PST319G(F)
Study Table
W700*D500*H760
RM 190



OF-SMK2
Study Table
W695*D455*H765
RM 155



OF-SMK3
Study Table
W635*D455*H760
RM 240



OF-SMK4
Study Table
W635*D455*H755
RM 165



OF-SMK6
Study Table
W635*D455*H760
RM 225



OF-SMK8
Study Table
W635*D455*H765
RM 215



888
Study Table
W710*D470*H760
RM 228



OF-OS801(L)
Study Table
W620*D400*H760
RM 178



FOR PROJECTS ONLY
OF-KZ-016(T)
Study Table
W600*D400*H760
CALL FOR BEST PRICE



***MOQ 10 UNIT**
OF-PST 318
Study Table
W745*D500*H760
RM 118



OF-PST328
Study Table
W745*D500*H760
RM 138



OF-SMK
Study Table
W635*D455*H755
RM 155



OF-STD-A
Study Table
W505*D378*H425
RM 70



FCT 2520
Study Table
W505*D378*H425
RM 178



FCT 2522
Study Table
W505*D378*H425
RM 168



OF-WST0007
Study Table (Foldable)
W700*D500*H760
RM 150



OF-WST0009
Study Table (Foldable)
W700*D500*H760
RM 198



OF-PST309(N)
Study Table
W601*D451*H760
RM 145



OF-PST315(N)
Study Table
W700*D500*H760
RM 180



OF-PST309(N)-TD
Study Table
W600*D451*H760
RM 178



OF-PST316(N)-TD
Study Table
W700*D500*H760
RM 230



OF-BDR2 / OF-BDM4
Study Table
W700*D500*H700
RM 175

OF-BDM4
Study Table
W700*D500*H760
RM 180



FOR PROJECTS ONLY
OF-SD928
Foldable Table c/w Castors
W650*D450*H750
CALL FOR BEST PRICE



FOR PROJECTS ONLY
OF-SD926
Stackable Table
W600*D450*H750
CALL FOR BEST PRICE

EDUCATION SERIES STUDENT CHAIR

MOBILE DISCUSSION CHAIR

Call for BEST PRICE



OF-822
RM 188



OF-822A
RM 258



OF-3012
RM 188



OF-3012A
RM 258



OF-41
RM 298



OF-41A
RM 328



OF-8000
RM 188



OF-8000A
RM 238



OF-831
RM 208



OF-812A
RM 258



OF-JP663(P)
RM 208



OF-JP663(P) + JP3
RM 278



OF-JP663P(W)
RM 278



OF-JP663
RM 145



OF-JP663 + JP3
RM 188



OF-JP663-W
RM 215



OF-7575-G
RM 228



OF-7575-AG
RM 248



OF-JP60
RM 140



OF-JP60+JP3
RM 170



OF-JP60-W
RM 215



JP666+JP4
RM 175



OF-JP662
RM 145



OF-JP-662+JP3
RM 175



OF-JP662-W
RM 215



JP633
RM 130



OF-JP332
RM 80



OF-JP335A
RM 85



OF-JP005
RM 145



OF-JP005 + JP3
RM 170



OF-JP005(W)
RM 175



OF-CT 618
RM 168



OF-CT-588
RM 168



OF-CT 608
RM 228



PFC 9020
RM 118



OF-SPM3022
RM 88



OF-IF706N
RM 118



OF-FS
RM 88



OF-2294
RM 48



MS911
RM 48



MS999
RM 42



OF-818
RM 45



OF-THPC
RM 48



BRM 4
RM 175



BRM 3
RM 180

SCHOOL DESKS & CHAIR SERIES

(ABS / HIGH DENSITY MELAMINE BOARD)



SJ2107

SPECIFICATION

Table : The panel adopts ABS impact resistant plastic one new material injection molding.
Table steel frame : elliptical pipe and steel pipe welding.
Book case : using PP plastic one new material injection molding.
Headrest : new PP impact resistant plastic injection molding.
Foot pedal : Set under the seat plate can turn the turning foot, the tread surface is made of PP impact resistant new plastic integrated injection molding.



SJ2106

SPECIFICATION

Table : ABS engineering material panel, with cup holder, ruler, pen slot.
Panel size : 650*450*25mm
Chair : PP plastic molding.
Desk bucket : PP plastic molding.
Table and chair shelf : 50*20*1.2mm and 60*30*1.2mm oval tube, integrated foot.



SJ2105

SPECIFICATION

Table : Environment-friendly high-density melamine board PVC. edge sealing, table size : 750*500*25mm (thickness).
Chair : PP plastic molding, lifting range:370-450mm.
Desk bucket : using high quality cold rolled steel plate stamping molding, thickness of 0.8mm.
Table and chair shelf : 50*20*1.2mm and 60*30*1.2mm oval tube, integrated foot.



SJ2104

SPECIFICATION

Table top : 600*400mm environmental protection high density melamine board injection molding edge sealing.
Drawer : cold rolled steel one time drawing forming no profit Angle, 460*605*150mm.
Hook : use 0.5mm diameter steel wire stamping on both sides.
Table supervisor : 40*20mm oval seamless cold rolled steel pipe, 1.2mm thick.
Table foot : 50*25mm oval seamless cold rolled steel pipe 1.2mm thick.
Book Network : 500*90*180mm.
Chair board : environmental HDPE plastic blow molding.



SJ2103

SPECIFICATION

Table top : 600*400mm environ -ment-friendly high-density melamine board around the edge injection molding.
Drawer : cold rolled steel one time drawing forming no profit Angle, 460*605*150mm.
Hook : use 0.5mm diameter steel wire stamping on both sides.
Chair frame : the circular tube $\varnothing 22*1.2$ mm and $\varnothing 19*1.2$ mm bending welding form.
Chair board : environmental HDPE plastic injection into fish tail type.



SJ2102

SPECIFICATION

Desktop : 635*450mm high quality ABS injection molding.
Chair cover / table bucket : High quality PP injection molding.
Desk frame : Using denier tube 60*30*1.2 mm and ABS connector.
Chair frame : 20*50*1.2mm and 30*60*1.2 mm high-quality denier tubes. Height adjustable.

SCHOOL / UNIVERSITY CLASSROOM SEATING SERIES



UNIVERSITY FIXED SEATING SJ320

- Seat and back : High density board surface process fireproof board, 15mm thickness seat board, 16mm thickness back board;
- Leg : Die-casting aluminium alloy molding.
- Coating : After pickling, phosphating and antirust treatment, static powder spraying and high- temperature baking;
- Seat recovery : Spring plus damping for flexible recovery, and free from noise,
- Writing table basket : Writing table basket: High strength sheet metal support formed by welding of 2mm cold-rolled steel tube and steel plate.
- Writing table : Writing table: 25mm thickness high-density particleboard, double-sided pressed fireproof board and PVC process edging are adopted.



UNIVERSITY FIXED SEATING SJ322

- Back panel : Made of curved multi-layer board, double-sided pressed high-quality fireproof board, thickness 14mm.
- Seat : Made of curved multi-layer board, double-sided pressed high-quality fireproof board, thickness 14mm.
- Writing board : multi-layer board, double-sided pressed high-quality fireproof board, 20mm thick recoverable.
- Standing feet : The standing feet are customized square tubes of 90-42-2.0, with welded steel feet. The surface is spray-coated with electrostatic powder spraying, and the bottom is equipped with a plastic foot cover.
- Recovery mechanism : adopts damping recovery mechanism, no sound and slow rebound.
- Book net : Iron book net, which is welded by iron wires with diameters of 5mm and 6mm and fixed pieces. The surface is rust-removed and then electrostatically powdered.



UNIVERSITY FIXED SEATING SJ323Y

- Seat and back board : 12mm thickness high density board surface process fireproof board.
- Seat and back sponge : Back density 30kg/m3, seat density 40kg/m3.comfortable to seat.
- Leg : 1.5mm thickness high quality steel tube, and sheet metal parts are stamped and welded by die.
- Seat recovery : The seat bag adopts silencing gravity recovery, and the seat limit adopts PU foaming process, which is beautiful and noise free.
- Writing table bracket : High quality class a cold-rolled 2mm steel pipe and steel plate are welded to form high-strength sheet metal support.
- Writing table : 25mm thickness high-density particleboard, double-sided pressed fireproof board and PVC process edging are adopted.
- Anti rust coating : after electrostatic baking and powder spraying at high temperature.



Back Middle Front
SJ302



Back Middle Front
SJ3081



Back Middle Front
SJ309A



MAGNETIC GLASS BOARD

ITEM	900*600	1200*900	1500*1200	1800*1200	2400*1200
MODEL	GWF23	GWF34	GWF45	GWF46	GWF48
Frame	RM 548	RM 828	RM 1,228	RM 1,478	RM 1,828
MODEL	MGW69	MGW912	MGW1215	MGW1218	MGW1224
Frameless	RM 388	RM 678	RM 1,118	RM 1,388	RM 1,738

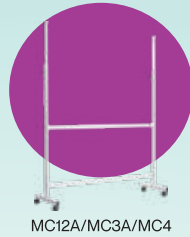

WHITE BOARD STAND
MC12A
RM 240
MC3A
RM 250
MC4
RM 348



WHITE BOARD STAND
WB123
RM 285



Aluminium Frame



Classic Wooden Frame



PRESENTATION & DISPLAY SUPPLIES

SIZE	ALUMINIUM FRAME							CLASSIC WOODEN FRAME						
	2' x 3'	3' x 4'	4' x 5'	4' x 6'	4' x 8'	4' x 10'	4' x 12'	2' x 3'	3' x 4'	4' x 5'	4' x 6'	4' x 8'	4' x 10'	4' x 12'
WRITING BOARD														
Non-Magnetic	RM 55	RM 108	RM 178	RM 215	RM 285	RM 470	RM 588							
Magnetic	RM 58	RM 115	RM 195	RM 230	RM 305	RM 507	RM 635	RM 360	RM 530	RM 605	RM 820	RM 1,060	RM 1,270	
Magnetic Green	RM 78	RM 158	RM 265	RM 315	RM 420	RM 640	RM 835	RM 405	RM 595	RM 680	RM 925	RM 1,105	RM 1,325	
Black Board	RM 65	RM 128	RM 215	RM 255	RM 340			RM 360	RM 545	RM 635	RM 860	-	-	
NOTICE BOARD														
Velvet	RM 95	RM 188	RM 310	RM 375	RM 498	RM 670	RM 810	RM 360	RM 508	RM 575	RM 720	RM 885	RM 1,020	
Foam	RM 68	RM 135	RM 225	RM 265	RM 355	RM 490	RM 588	RM 325	RM 455	RM 515	RM 645	RM 778	RM 940	
Fabric	RM 95	RM 188	RM 310	RM 375	RM 498	RM 670	RM 810	RM 360	RM 508	RM 575	RM 720	RM 885	RM 1,020	
Cork	RM 98	RM 198	RM 328	RM 395	RM 528	RM 705	RM 850	RM 388	RM 545	RM 625	RM 765	RM 975	RM 1,225	
Softboard	RM 68	RM 135	RM 225	RM 265	RM 335	RM 490	RM 588	RM 325	RM 455	RM 515	RM 645	RM 778	RM 940	
SLIDING GLASS BOARD														
Magnetic	RM 425	RM 635	RM 940	RM 1,080	RM 1,380	RM 1,765	RM 2,125	RM 600	RM 890	RM 1,210	RM 1,375	RM 1,735	RM 2,248	RM 2,738
Velvet	RM 425	RM 635	RM 940	RM 1,080	RM 1,380	RM 1,765	RM 2,125	RM 600	RM 890	RM 1,210	RM 1,375	RM 1,735	RM 2,248	RM 2,738
Foam	RM 395	RM 595	RM 858	RM 980	RM 1,308	RM 1,618	RM 1,960	RM 580	RM 850	RM 1,158	RM 1,348	RM 1,798	RM 2,148	RM 2,638
Fabric	RM 425	RM 635	RM 940	RM 1,080	RM 1,380	RM 1,765	RM 2,125	RM 600	RM 890	RM 1,210	RM 1,375	RM 1,735	RM 2,248	RM 2,738
Cork	RM 438	RM 658	RM 975	RM 1,115	RM 1,430	RM 1,825	RM 2,265	RM 625	RM 908	RM 1,245	RM 1,425	RM 1,798	RM 2,360	RM 2,795
Softboard	RM 395	RM 595	RM 858	RM 980	RM 1,308	RM 1,618	RM 1,960	RM 580	RM 850	RM 1,158	RM 1,050	RM 1,798	RM 2,148	RM 2,638



ZI43C
W1300*D500*H1750 **RM 550**
ZI54C
W1600*D500*H1900 **RM 735**
ZI64C
W1900*D500*H1900 **RM 830**
ZI84C
W2500*D500*H1900 **RM 1,015**



VO43C
W1300*D500*H1750 **RM 620**
VO54C
W1600*D500*H1900 **RM 820**
VO64C
W1900*D500*H1900 **RM 930**
VO84C
W2500*D500*H1900 **RM 1,105**



VI23C
W700*D500*H1750 **RM 510**
VI34C
W1000*D500*H1900 **RM 695**

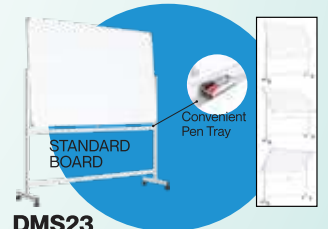

DMS23
W950*D500*H1600 **RM 388**
DMS34
W1250*D500*H1750 **RM 510**
DMS45
W1550*D500*H1940 **RM 675**
DMS46
W1850*D500*H1940 **RM 750**
DMS48
W2450*D500*H1940 **RM 915**

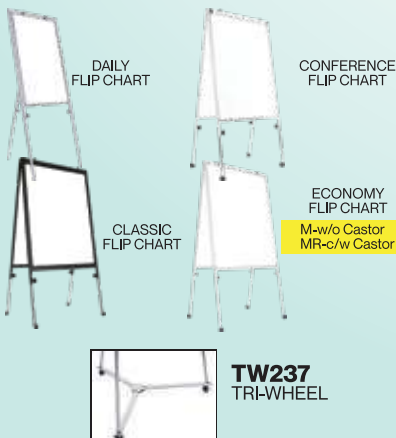

ITEM	SIZE	PRICE
ECONOMY FLIP CHART		
EF23M	W640*D770*H1700	RM 260
EF23MR	W640*D770*H1700	RM 298
EF34M	W940*D700*H1800	RM 368
EF34MR	W940*D700*H1800	RM 405
CONFERENCE FLIP CHART		
FC23R	W660*D770*H1700	RM 518
FC34R	W960*D700*H1800	RM 645
CLASSIC FLIP CHART		
CF23R	W660*D770*H1700	RM 580
CF34R	W960*D700*H1800	RM 715
DAILY FLIP CHART		
DT23	W640*D770*H1700	RM 225
DT34	W860*D700*H1800	RM 375

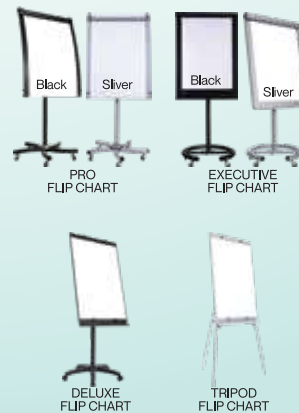

Optional tri-wheel for mobility (sold separately)
TW237 RM 82

ITEM	SIZE	PRICE
PRO FLIP CHART		
EX81B	W720*D700*H1800	RM 1,185
EX81S	W720*D700*H1800	RM 1,185
EXECUTIVE FLIP CHART		
EX71B	W720*D700*H1800	RM 1,025
EX71S	W720*D700*H1800	RM 1,025
DELUXE FLIP CHART		
DF80	W650*D650*H1800	RM 470
TRIPOD FLIP CHART		
TF70	W650*D770*H1800	RM 298

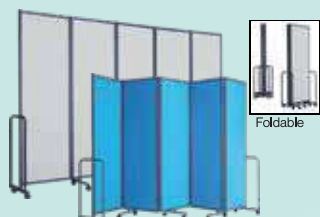

LAMBO PANEL

Velvet colour chart:

ITEM	PANEL	SIZE (W*D*H)MM	PRICE
WPLB3	3	1870*540*1800	RM 1,988
WPLB5	5	3080*540*1800	RM 3,138
WPLB7	7	4280*540*1800	RM 4,328

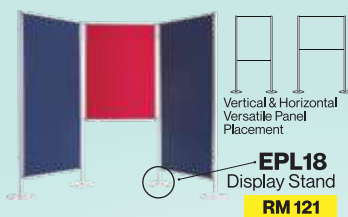

EPL18 Display Stand

Vertical & Horizontal Versatile Panel Placement

RM 121

FLEXI DISPLAY PANEL

ITEM	SIZE	PRICE
EPD34	900*600	RM 310
EPD35	900*1500	RM 445
EPD36	900*1800	RM 550
EPD44	1200*1200	RM 390
EPD45	1200*1500	RM 445
EPD46	1200*1800	RM 550



MDB2 Join Bracket

RM 65

Fabric colour chart:

BORNEO MOBILE PANEL

ITEM	SIZE	PRICE
MDP53	850*1390	RM 688
MDP63	850*1690	RM 715
MDP44	1150*1090	RM 588
MDP54	1150*1390	RM 688
MDP64	1150*1690	RM 715



Fabric colour chart:

PLUS MOBILE PANEL

ITEM	SIZE	PRICE
PM36	860*1500	RM 755
PM46	1160*1500	RM 755

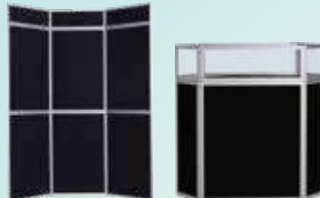

SDS01 Display Showcase
W920*D490*H920
RM 2,438

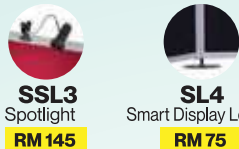

SSL3 Spotlight
RM 145

SL4 Smart Display Leg
RM 75

Velvet colour chart:

SMART FOLDING DISPLAY

ITEM	SIZE	PRICE
SD3	1800*900	RM 820
SD4	1200*1800	RM 1,055
SD6	1800*1800	RM 1,515
SD7	1800*1800	RM 1,735
SD8	2400*1800	RM 1,960

ITEM	SIZE	PRICE
SD3H	1800*1100	RM 930
SD4H	1200*2000	RM 1,308
SD6H	1800*2000	RM 1,878
SD7H	1800*2000	RM 2,107
SD8H	2400*2000	RM 2,468

DELUXE Q-UP STAND



Colour Option:

RM 178

FREE Silk Screen printing with MOQ 40pcs

QS88 Signages (Portrait)
RM 148

Signages (Landscape)
RM 148

ITEM	BASE/POLE/HEIGHT (DIA/DIA/H) MM	BELT LENGTH	WEIGHT (KG)
OF-QUS-303S-BLU	360/50/900	2000	9.5
OF-QUS-303S-RED	360/50/900	2000	9.5
OF-QUS-303S-BLK	360/50/900	2000	9.5

CLASSIC Q-UP STAND

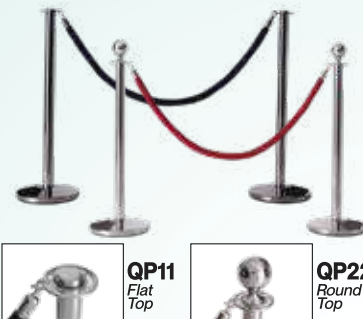

QP11 Flat Top

QP22 Round Top

ROPE RM 88

ITEM	LENGTH (MM)	COLOUR
QR15B	1500	BLUE
QR2B	2000	BLUE
QR15R	1500	RED
QR2R	2000	RED

STAND	PRICE
QP11	RM 170
QP22	RM 170

BARRICADE



Close Up

Locking System

ITEM	SIZE (W*H*D)MM	PRICE
BC4	1250*1100*550	RM 278
BC5	1520*1100*550	RM 318
BC6	1790*1100*550	RM 408
BC8	2320*1100*550	RM 458

METAL EXPANDABLE BARRIER



CALL FOR BEST PRICE

- Design to restrict access to danger and temporary hazard areas.
- Compact, portable and lightweight to use at indoor and outdoor.

DESCRIPTION & MATERIAL	
ITEM	TSEMB24
SIZE	950*220*2500 (MM)
COLOUR	YELLOW / BLACK
DESIGN	C/W WHEEL



PLAN HANGER STAND

ITEM	SIZE	PRICE
PHS188	535*660*1365	RM 355
PHS288	685*660*1365	RM 388
PHS388	990*660*1365	RM 425
WB00	L885	RM 44
WB01	L670	RM 40



STAINLESS STEEL SIGNBOARD

ITEM	SIZE	PRICE
SA4P	210*297*1270	RM 405
SA4L	297*210*1270	RM 405
SA3P	297*420*1460	RM 430
SA3L	420*297*1400	RM 430



KEY PANELS

ITEM	SIZE	PRICE
KEY96	900*76*600	RM 455
KEY126	900*76*600	RM 490
KEY220	1200*76*900	RM 745
KEY290	1200*76*900	RM 815



KEY CABINET

ITEM	SIZE	PRICE
WB32K	278*67*328	RM 150
WB48K	278*67*482	RM 190
WB72K	400*67*482	RM 240
WB96K	400*67*628	RM 290
WB120K	400*67*784	RM 350
WB150K	480*67*784	RM 420

STAINLESS STEEL & RECYCLE BIN

RECTANGULAR STAINLESS STEEL BIN



SUGO 431 Size: L255*W235*H610
 SUGO 432 Size: L400*W300*H760
 SUGO 441 Size: L380*W230*H750
 SUGO 442 Size: L380*W230*H750



CODE	LITRES	PRICE
SUGO 431A	15	RM 278
SUGO 431FT	15	RM 258
SUGO 431ST	15	RM 328
SUGO 431TO1	22	RM 268
SUGO 432A	41	RM 618
SUGO 432FT	41	RM 578
SUGO 432ST	41	RM 668
SUGO 432TO1	59	RM 598
SUGO 441ST	35	RM 518
SUGO 441TO1	35	RM 498
SUGO 442ST	35	RM 568

ROUND STAINLESS STEEL BIN



SUGO 103 Size: Ø345*H785
 SUGO 126 Size: Ø245*H610
 SUGO 127 Size: Ø245*H760
 SUGO 128 Size: Ø295*H760
 SUGO 129 Size: Ø380*H760

CODE	LITRES	PRICE
SUGO 103A1	47	RM 488
SUGO 103D/FT	36	RM 408
SUGO 103ST	47	RM 518
SUGO 103TO1/2	47	RM 468
SUGO 126A1/2	15	RM 218
SUGO 126D/FT	15	RM 188
SUGO 126ST	21	RM 268
SUGO 126TO1/2	21	RM 208
SUGO 127A1/2	24	RM 258
SUGO 127D/FT	24	RM 238

CODE	LITRES	PRICE
SUGO 127ST	24	RM 308
SUGO 127TO1/2	24	RM 238
SUGO 128A1/2	28	RM 318
SUGO 128D/FT	28	RM 308
SUGO 128ST	28	RM 378
SUGO 128TO1/2	40	RM 308
SUGO 129A1	50	RM 518
SUGO 129D/FT	50	RM 488
SUGO 129ST	68	RM 598
SUGO 129TO1/2	45	RM 498



PEDAL BIN SERIES

CODE	SIZE	LITRES	PRICE
SUGO 152	Ø245*H350	10	RM 218
SUGO 153	Ø245*H450	22	RM 278
SUGO 154	Ø245*H610	29	RM 298
SUGO 155	Ø295*H450	32	RM 428
SUGO 156	Ø345*H450	43	RM 518
SUGO 157	Ø295*H785	56	RM 608
SUGO 158	Ø345*H785	75	RM 658

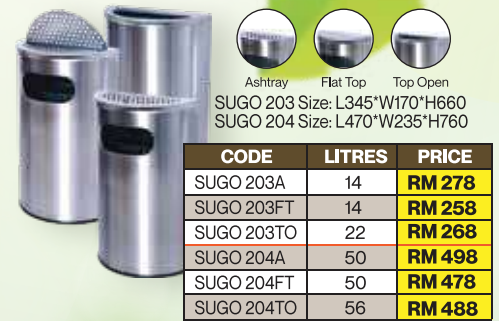

HALF ROUND STAINLESS STEEL

CODE	LITRES	PRICE
SUGO 203A	14	RM 278
SUGO 203FT	14	RM 258
SUGO 203TO	22	RM 268
SUGO 204A	50	RM 498
SUGO 204FT	50	RM 478
SUGO 204TO	56	RM 488

PLASTIC / STAINLESS STEEL RECYCLE BIN



• 2 Bins
SUGO 1038
 L760*D380*H800
RM 2,358

• 3 Bins
 • Inner Liners
SUGO 1005
 L380*D230*H740
RM 1,728

• 3 Bins
 • Inner Liners
SUGO 1009
 Ø295*H760
RM 1,368

• 3 Bins
 • Inner Liners
SUGO 1010
 Ø295*H760
RM 1,528

• 3 Bins
 • Inner Liner
SUGO 1020/3
 L1140*W380*H800
RM 3,388

• 4 Bins
 • Quadro Recycle Bin
SUGO 1024/4
 L1600*W400*H800
RM 4,418



• 4 Bins
 • Quadro Recycle Bin
SUGO 1028/4
 L1424*D380*H800
RM 4,418



• 4 Bins
 • Quadro Recycle Bin
SUGO 1029
 L1424*D380*H800
RM 4,418



• 3 Bins
 • Inner Bin
 • Front Load
SUGO 141P
 Ø400*H830
RM 1,358



• 3 Bins
 • Inner Bin
 • Top Load
SUGO 142P
 Ø400*H830
RM 1,358



• 3 Bins
 • Inner Bin
 • Front Load
SUGO 144P
 Ø380*H810
RM 1,548



• 3 Bins
 • Inner Bin
 • Top Load
SUGO 145P
 Ø380*H810
RM 1,548



• 3 Bins
 • Swing Door
SUGO 146P
 L380*W380*H830
RM 1,348



• 3 Bins
 • Flap Door
SUGO 149P
 L505*W510*H980
RM 1,888



• 3 Bins
 • Inner Bin
 • Plastic Lid
 • Top Load
SUGO 150P
 L355*W355*H700
RM 1,318



• 3 Bins
 • Inner Bin
 • Swing
 • Pivot Top
SUGO 152P
 L380*W245*H745
RM 2,288



• 3 Bins
 • Inner Bin
 • Top Load
SUGO 153P
 L380*W245*H745
RM 2,188



• 3 Bins
 • Inner Bin
SUGO 154P
 Ø483*H660
RM 1,188

AUDITORIUM SEATING SERIES



*PRICE FROM **RM450** PER SEAT, FOR PROJECT ONLY!!!

CALL FOR BEST PRICE & SPECIFICATION



FAEL-RAF-P



SJ6706



SJ9707



ALPHA



ECHO



GAMMA



SJ8602



SJ6602



SOUND ABSORPTION

Pass the acoustic test, the special sound-absorbing holes on the seat plate can effectively reduce the noise and greatly improve the sound quality in the theater.



FLAME RETARDANT

The seat & back is made of cold foamed foam, which can be processed with flame retardant function, so that the seat is not easily deformed under long-term use and is durable.



RECOVERY MECHANISM

Spring and damping recovery mechanism, sound absorption and noise reduction, stable and reliable.



COMPRESSION TEST

Seat comprehensive testing machine: Carry out durability test on the auditorium chair, and test the mechanical structure safety, stability, strength and durability of the seat.

HOSTEL SERIES **CALL FOR BEST PRICE**



SCHOOL & COLLEGE LAB FURNITURE

CALL FOR BEST PRICE

CAFETERIA FOLDING TABLES SERIES **CALL FOR BEST PRICE**



• Images provided are for illustration purposes only. • Prices quoted are subject to change without prior notice & while stocks last. • Terms & conditions apply. • While every care is taken in the preparation of this flyer any inaccuracy or omission is much regretted.

ESD DRAFTING CHAIR (PRO SERIES)

CALL FOR BEST PRICE



CH-PRO500-PVC



CH-PRO500-FOAM



CH-PRO032-AS-DF



CH-PRO049-1JF



CH-PRO042

MODEL	SURFACE SIZE	SURFACE MATERIAL	ADJUST HEIGHT	SYSTEM RESISTANCE
CH-PRO500-PVC	460 * 420 MM	ANTISTATIC PVC LEATHER	584 - 845 MM	10e6 to 10e9
CH-PRO500-FOAM	400 * 410 MM	PU FOAM	584 - 845 MM	10e6 to 10e9
CH-PRO032-AS-DF	440 * 440 MM	PU FOAM	CALL FOR MORE DETAILS	5.76 * 10e4 - 5.76 * 10e5
CH-PRO049-1JF	460 * 420 MM	PU FOAM	490 - 680 MM	5.76 * 10e4 - 5.76 * 10e5
CH-PRO042	460 * 420 MM	PU FOAM	CALL FOR MORE DETAILS	5.76 * 10e4 - 5.76 * 10e6

ESD TYPIST CHAIR (PRO SERIES)

CALL FOR BEST PRICE



CH-PRO560-PVC



CH-PRO032-AS



CH-PRO143-TP



CH-PRO049-TP



CH-PRO050

MODEL	SURFACE SIZE	SURFACE MATERIAL	ADJUST HEIGHT	SYSTEM RESISTANCE
CH-PRO560-PVC	460 * 420 MM	ANTISTATIC PVC LEATHER	390 - 510 MM	10e6 to 10e9
CH-PRO032-AS	400 * 410 MM	PU FOAM	390 - 520 MM	5.76 * 10e4 - 5.76 * 10e5
CH-PRO143-AP		PU FOAM	430 - 570 MM	5.76 * 10e4 - 5.76 * 10e5
CH-PRO049-TP	460 * 420 MM	PU FOAM	CALL FOR MORE DETAILS	5.76 * 10e4 - 5.76 * 10e5
CH-PRO050	460 * 420 MM	PU FOAM	CALL FOR MORE DETAILS	5.76 * 10e4 - 5.76 * 10e5

ESD TYPIST / DRAFTING STOOL (PRO SERIES)

CALL FOR BEST PRICE



CH-PRO600-PVC



CH-PRO600-FOAM



CH-PRO580-PVC



CH-PRO001-DL



CH-PRO005-AL

MODEL	SURFACE SIZE	SURFACE MATERIAL	ADJUST HEIGHT	SYSTEM RESISTANCE
CH-PRO600-PVC	Ø 350 MM	ANTISTATIC PVC LEATHER	584 - 845 MM	10e6 to 10e9
CH-PRO600-FOAM	Ø 535 MM	PU FOAM	584 - 845 MM	10e6 to 10e9
CH-PRO580-PVC	Ø 350 MM	ANTISTATIC PVC LEATHER	390 - 510 MM	10e6 to 10e9
CH-PRO001-DL	320 * 355 MM	PU FOAM	570 - 800 MM	5.76 * 10e4 - 5.76 * 10e5
CH-PRO005-AL	Ø 340 MM	PU FOAM	430 - 585 MM	5.76 * 10e4 - 5.76 * 10e5

*Images provided are for illustration purposes only. *Prices quoted are subject to change without prior notice & while stocks last. *Terms & conditions apply. *While every care is taken in the preparation of this flyer any inaccuracy or omission is much regretted.

Chubb safes

Trusted the world over

GUNNEBO For a safer world



Guardian



Guardian DCR



* FREE delivery to ground floor only.
* Extra charges apply for 1st floor & above
* Terms & Conditions apply.



CALL FOR BEST PRICE!



Castle Safe



Custodian Safe



Mini Banker Safe



E35KL Imported Digital Safes



E50KL Imported Digital Safes



Duoguard Grade I Safe



Mini Banker Safe C/W NDT



VIPER Imported Digital Safes



Fortress Safe



Dataguard NT Safe



RPF Cabinet



Chubb safes CASTLE

Home/Office Burglary & Fire Resistant Safe

Secure by Key & Electronic Lock

MODEL	WEIGHT	SIZE	FIRE RESISTANCE	PRICE		
DIGITAL SAFE						
E35KL	42kg	W424*D388*H344	60 mins	RM 1,488 c/w Overriding Key		
E50KL	60kg	W420*D445*H520	60 mins	RM 1,788 c/w Overriding Key		
CASTLE SAFE						
060	96kg	W491*D467*H542	60 mins	RM 2,668		
070	120kg	W549*D507*H669	60 mins	RM 3,228		
080	185kg	W580*D507*H791	60 mins	RM 3,578		
100	200kg	W585*D507*H992	60 mins	RM 4,228		
MINI BANKER SAFE						
				KeyLock	Combination	Digital Lock
SIZE 2	180kg	W435*D445*H488	40 mins	RM 2,988	RM 2,978	RM 3,978
SIZE 3	210kg	W435*D445*H590	40 mins		RM 3,358	RM 4,348
SIZE 4	300kg	W550*D560*H590	40 mins		RM 4,208	RM 5,198
SIZE 5	340kg	W550*D560*H717	40 mins		RM 4,508	RM 5,498
SIZE 6	400kg	W550*D560*H894	40 mins		RM 4,988	RM 5,978
SIZE 7	540kg	W640*D650*H1047	40 mins		RM 5,558	RM 6,548
MINI BANKER SAFE c/w NIGHT DRAWER TRAP						
SIZE 3	360kg	W435*D445*H844	40 mins	RM 5,346		
SIZE 4	450kg	W550*D560*H844	40 mins	RM 6,346		
SIZE 5	490kg	W550*D560*H971	40 mins	RM 6,646		
RPF CABINET						
				Individual Locking	Central Locking	
5202	210kg	W551*D824*H839	120 mins	RM 3,458	RM 3,338	
5203	310kg	W551*D824*H1209	120 mins	RM 4,538	RM 4,368	
5204	390kg	W551*D824*H1573	120 mins	RM 5,888	RM 5,688	

MODEL	WEIGHT	SIZE	FIRE RESISTANCE	PRICE
FORTRESS SAFE				
SIZE 1	360kg	W560*D520*H680	60 mins	RM 4,958
SIZE 2	515kg	W620*D580*H880	60 mins	RM 6,288
SIZE 3	670kg	W680*D640*H1080	60 mins	RM 7,388
SIZE 4	1215kg	W740*D870*H1550	60 mins	RM 11,918
CUSTODIAN SAFE				
SIZE 1	370kg	W560*D550*H680	120 mins	RM 5,218
SIZE 2	530kg	W620*D610*H880	120 mins	RM 6,608
SIZE 3	720kg	W680*D680*H1080	120 mins	RM 7,938
SIZE 4	1250kg	W740*D900*H1550	120 mins	RM 12,378
DUOGUARD GRADE I SAFE				
MODEL 115	161kg	W600*D561*H690	60 mins	RM 9,378
MODEL 150	196kg	W600*D561*H875	60 mins	RM 10,428
MODEL 205	243kg	W600*D561*H1150	60 mins	RM 12,078
MODEL 290	322kg	W600*D561*H1600	60 mins	RM 14,628
DATAGUARD NT SAFE				
MODEL 30	145kg	W546*D566*H530	120 mins	CALL FOR BEST PRICE
MODEL 50	190kg	W546*D566*H700	120 mins	
MODEL 90	263kg	W546*D590*H1025	120 mins	
MODEL 130	330kg	W702*D590*H1025	120 mins	
VIPER SAFE				
MODEL 35	42kg	W445*D390*H450	30 mins	RM 2,838
MODEL 50	53kg	W445*D390*H600	30 mins	RM 3,378
MODEL 70	65kg	W445*D390*H800	30 mins	RM 3,908
MODEL 90	78kg	W445*D390*H1000	30 mins	RM 4,388

OF-300T PLUS



SIZE : W510*D530*H810
WEIGHT : 330 KGS
FIRE RESISTANCE : 120 mins

RM 3,288

OF-100T PLUS



SIZE : W530*D460*H510
WEIGHT : 210 KGS
FIRE RESISTANCE : 120 mins

RM 2,488

OF-300 PLUS



SIZE : W510*D530*H690
WEIGHT : 285 KGS
FIRE RESISTANCE : 120 mins

RM 2,688

OF-200 PLUS



SIZE : W510*D530*H580
WEIGHT : 250 KGS
FIRE RESISTANCE : 120 mins

RM 2,088/2,488*
*with envelope slot

OF-100 PLUS



SIZE : W530*D460*H390
WEIGHT : 170 KGS
FIRE RESISTANCE : 120 mins

RM 1,788

COMPACT SERIES SAFE
BURGLAR & FIRE RESISTANT



COMBINATION LOCK



DIGITAL LOCK



COMBINATION LOCK



WHILE STOCKS LAST!

D-30N [Digital]
SIZE : W450*D380*H230
WEIGHT : 19 KGS
FIRE RESISTANCE : NO

RM 278



1 SF-OF-P50S [Combination]
SIZE : W420*D390*H400
WEIGHT : 50 KGS
FIRE RESISTANCE : 120 mins **RM 598**

2 SF-OF-P50D [Digital]
SIZE : W420*D390*H400
WEIGHT : 50 KGS
FIRE RESISTANCE : 120 mins **RM 698**

3 SF-OF-P70S [Combination]
SIZE : W450*D420*H570
WEIGHT : 70 KGS
FIRE RESISTANCE : 120 mins **RM 838**

4 SF-OF-P70D [Digital]
SIZE : W450*D420*H570
WEIGHT : 70 KGS
FIRE RESISTANCE : 120 mins **RM 888**



5 SF-OF-P125S [Combination]
SIZE : W500*D470*H670
WEIGHT : 125 KGS
FIRE RESISTANCE : 120 mins **RM 1,088**

6 SF-OF-P125D [Digital]
SIZE : W500*D470*H670
WEIGHT : 125 KGS
FIRE RESISTANCE : 120 mins **RM 1,268**

7 SF-OF-P175SC [Combination]
SIZE : W590*D505*H880
WEIGHT : 175 KGS
FIRE RESISTANCE : 120 mins **RM 1,888**

8 SF-OF-P175D [Digital]
SIZE : W590*D505*H880
WEIGHT : 175 KGS
FIRE RESISTANCE : 120 mins **RM 1,999**

9 SF-OF-P230SC [Combination]
SIZE : W600*D530*H1000
WEIGHT : 230 KGS
FIRE RESISTANCE : 120 mins **RM 2,188**

10 SF-OF-P230D [Digital]
SIZE : W600*D530*H1000
WEIGHT : 230 KGS
FIRE RESISTANCE : 120 mins **RM 2,388**

11 SF-OF-P322SC [Combination]
SIZE : W700*D630*H1385
WEIGHT : 322 KGS
FIRE RESISTANCE : 120 mins **RM 2,988**

12 SF-OF-P322D [Digital]
SIZE : W700*D630*H1385
WEIGHT : 322 KGS
FIRE RESISTANCE : 120 mins **RM 3,288**



CHARACTERISTICS



Beautiful wood grain from polywood



Very strong & solid



Fine welding workmanship & quality aluminium screw & hardware. For table, carton box include assembly instruction (AI).



OF-T931 + C708 (1+4)

OUTDOOR 4 SEATERS
T : 850 x 850 x 730 MM
C : W550 D490 H880

RM 1,548



OF-T927 + C7201 (1 + 4)

OUTDOOR 4 SEATERS
T : 900RD x 760 MM
C : W550 D470 H880

RM 1,498

DIMENSIONS OF TABLE & CHAIR



OF FRESCO R800
H750 Ø800MM

RM 638



OF DENVER 70120
H750 L1200 W700 MM

RM 888



OF DENVER SQ800
H750 L800 W800 MM

RM 688



OF LORAIN ARM CHAIR
H785 L560 W560 MM

RM 338



OF SANDY ARM CHAIR
H870 L630 W560 MM

RM 408



OF FRESCO ARM CHAIR
H880 L620 W560 MM

RM 338



OF DENVER ARM CHAIR
H870 L560 W560 MM

RM 338

HOSPITALITY



SOOTHE VISITOR SERIES



E3691H
500-630 (W)
490 - 730 (D)
1070 (H)

E3693H
760 (W)
1850 (D)
720 (H)



E3692H
500-630 (W)
490 - 630 (D)
1080 (H)



ROOF POD SERIES

CALL FOR BEST PRICE

benithem[®]
Let our Quality do the Talking...



ROOF SINGLE POD



An even greater invention to maximise noise reduction and enhance seclusion to make the environment a viable one to work in, be it for a group discussion or to focus on individual work.

HIGH ACOUSTIC RATING
Roof Double Pod offers an acoustic workplace for 1-2 people to work away from their desk. No longer bothering or being bothered by co-workers.

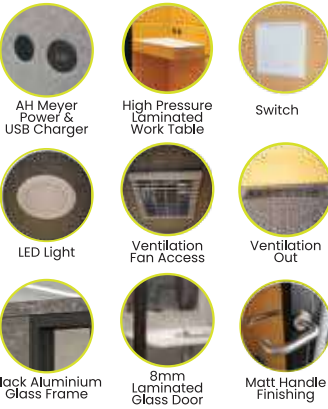

ROOF MEETING POD



A combination of functionality and ergonomics, ROOF DOUBLE POD is aesthetically pleasing and practical to have in a workplace. Furthermore, with a variety of colours to choose from, you can mix around to complement the view of the whole office.

ROOF DOUBLE POD T1-G



HIGH ACOUSTIC RATING
Roof Double Pod offers an acoustic workplace for 1-4 people to work away from their desk. No longer bothering or being bothered by co-workers.

ROOF DOUBLE POD T2

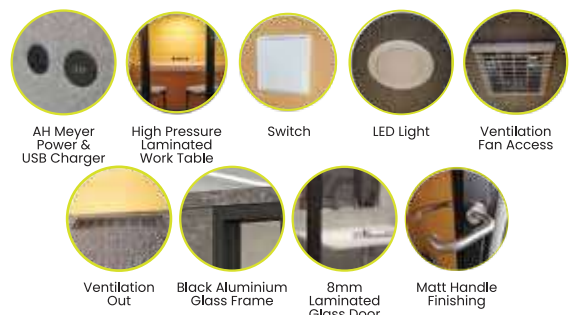

• Images provided are for illustration purposes only. • Prices quoted are subject to change without prior notice & while stocks last. • Terms & conditions apply. • While every care is taken in the preparation of this flyer any inaccuracy or omission is much regretted.

CARREL-OFFICE & HOME SERIES

CALL FOR BEST PRICE



OFIS Booth could be your new favourite room in the office. It creates opportunities to deliver new ways of working and ensure your floor provides a healthy balance between collaborative and focused work. NX Booth's creative construction makes portability and versatility an option, suiting clients who don't want their office interior to look common and dull.

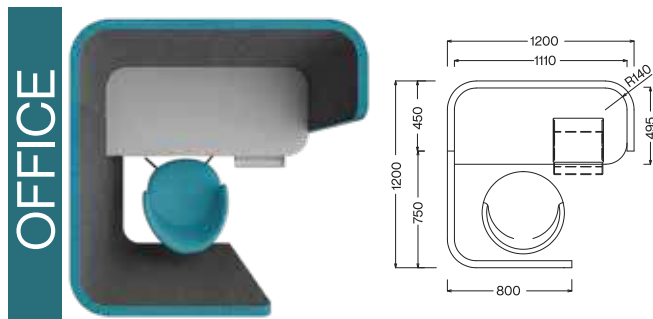

SIZE : (L) 1200 mm * (W) 1200 mm * (HT) 1350 mm

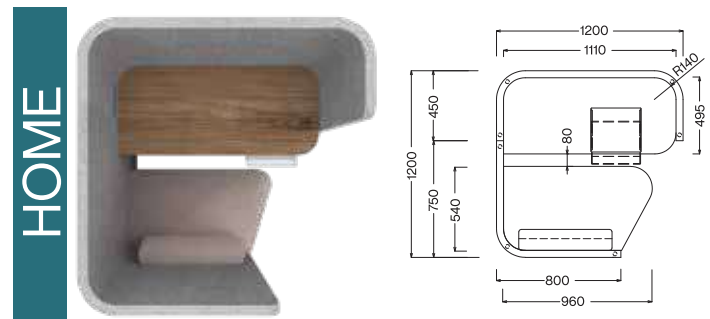

SIZE : (L) 1200 mm * (W) 1200 mm * (HT) 1350 mm

SPECIFICATION

1. Table Top

1110 mm (L) x 495 mm (W) x 25 mm (thk) table top come in Walnut / White / Graphite color in matte finish.

2. Panel

a) 1200 mm (L) x 450 mm (W) x 1350 mm (HT) x 40 mm (thk) fabric panel in light grey color inner side, bright color selection for outer panel in light grey color inner side, bright color selection for outer side of fabric knitting panel.

b) 800 mm (L) x 750 mm (W) x 1350 mm (HT) x 40 mm (thk) fabric panel in light grey color inner side, bright color selection for outer side of fabric knitting panel.

3. Plug Point

a) 2 gang 13 amp. Plug point come with USB charger attached with the fabric panel at the side.

4. Designer Chair

Dia. 530 mm x 775 mm (ht) designer chair in selected fabric knitting & PU in various colors, come with 4 nos. 60 mm dia. Polyurethane dual-wheel & 4 nos. fixed rubber studs.

5. Stationary Drawer

323 mm (L) x 283 mm (W) x 60 mm (HT) stationary drawer in white color, self-adhesive provided.

SPECIFICATION

1. Table Top

1110 mm (L) x 495 mm (W) x 25 mm (thk) table top come in Walnut / White / Graphite color in matte finish.

2. Customade Sofa

960 mm (L) x 540 mm (W) x 450 mm (ht) customize sofa to fit in with the home-booth concept, come with various fabric knitting colors selected.

3. Customade Backrest Cushion

600 mm (L) x 120 mm (W) x 300 mm (HT) customize Polyurethane sponge backrest cushion in various knitting fabric color selection, come with strappy tape at behind. - 1 no.

4. Panel

a) 1200 mm (L) x 450 mm (W) x 1350 mm (HT) x 40 mm (thk) fabric panel in light grey color inner side, bright color selection for outer side of fabric knitting panel.

b) 800 mm (L) x 750 mm (W) x 1350 mm (HT) x 40 mm (thk) fabric panel in light grey color inner side, bright color selection for outer side of fabric knitting panel.

5. Plug Point

a) 2 gang 13 amp. Plug point come with USB charger attached with the fabric panel at the side.

6. Stationary Drawer

323 mm (L) x 283 mm (W) x 60 mm (HT) stationary drawer in white color, self-adhesive provided.

CARREL-DISCUSSION SERIES CALL FOR BEST PRICE



The complementary NX Booth keeps you charged and connected, while ensuring your workspace is organized and clutter-free. The decorative acoustic panels absorb and deaden the noise, carrying out the primary function of soundproofing the overall space. It also adds aesthetically to the overall environment.



SIZE : (L) 2000 mm * (W) 1500 mm * (HT) 1350 mm

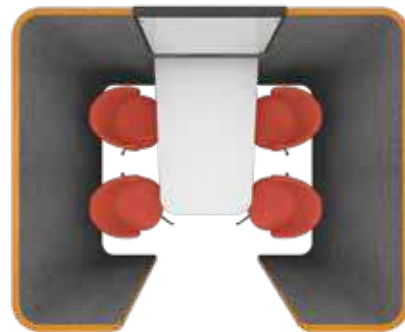
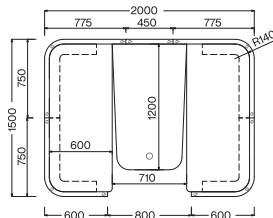

SIZE : (L) 2200 mm * (W) 1800 mm * (HT) 1350 mm

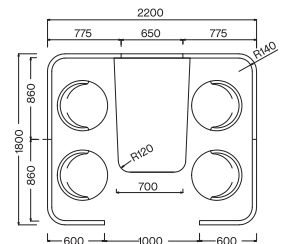

SPECIFICATION

1. Discussion Table

1200 mm (L) x 710 mm (W) x 25 mm (thk) table top come in White / Graphite color in matte finish, come with dia. 60 mm x 700 mm (ht) aluminium pole in polish finish.

2. Customade Sofa

1410 mm (L) x 600 mm (W) x 450 mm (ht) customize sofa to fit in with the home – booth concept, come with various fabric knitting colors selected. – 2 nos.

3. Customade Backrest Cushion

710 mm (L) x 550 mm (W) x 350 mm (HT) x 100 mm (thk) customade Polyurethane sponge backrest cushion in various knitting fabric color selection, come with strappy tape at behind. – 4 nos.

4. Plug Point

4 gang 13 amp. Plug point come with USB charger attached with the fabric panel at the side.

5. Panel

a) 750 mm (L) x 600 mm (W) x 1350 mm (HT) x 40 mm (thk) fabric panel in light grey color inner side, bright color selection for outer side of fabric knitting panel. – 2 nos.

b) 750 mm (L) x 775 mm (W) x 1350 mm (HT) x 40 mm (thk) fabric panel in light grey color inner side, bright color selection for outer side of fabric knitting panel. – 2 nos.

c) 450 mm (L) x 1350 mm (HT) x 40 mm (thk) fabric panel in light grey color inner side, bright color selection for outer side of fabric knitting panel. – 1 no.

SPECIFICATION

1. Discussion Table

1200 mm (L) x 800 mm (W) x 25 mm (thk) table top come in Walnut / White / Graphite color in matte finish, come with dia. 60 mm x 700 mm (ht) aluminium pole in polish finish.

2. Panel

a) 900 mm (L) x 600 mm (W) x 1350 mm (HT) x 40 mm (thk) fabric panel in light grey color inner side, bright color selection for outer side of fabric knitting panel. – 2 nos.

b) 900 mm (L) x 775 mm (W) x 1350 mm (HT) x 40 mm (thk) fabric panel in light grey color inner side, bright color selection for outer side of fabric knitting panel. – 2 nos.

c) 650 mm (L) x 1350 mm (HT) x 40 mm (thk) fabric panel in light grey color inner side, bright color selection for outer side of fabric knitting panel. – 1 no.

3. Plug Point

4 gang 13 amp. Plug point come with USB charger attached with the fabric panel at the side.

4. Designer Chair

Dia. 530 mm x 775 mm (ht) designer chair in selected fabric knitting & PU in various colors, come with 4 nos. 60 mm dia. Polyurethane dual – wheel & 4 nos. fixed rubber studs.

EBA



EBA 1128
S - RM 1,688
C - RM 1,988

WEIGHT : 10.5KG / 20L
 DIMENSIONS (H*W*D) : 516*345*213 MM

SHEET CAPACITY:

S : 4 MM (9-13) **C** : 3 x 25 MM (5-7)
 : 2 x 15 MM (3-5)



EBA 1824
S - RM 3,088
C - RM 3,388

WEIGHT : 22KG / 35L
 DIMENSIONS (H*W*D) : 635*395*291 MM

SHEET CAPACITY:

S : 4 MM (22-24) **C** : 4 x 40 MM (16-18)
 : 2 x 15 MM (11-13)



EBA 2331
S - RM 5,999
C - RM 6,688

WEIGHT : 52KG / 120L
 DIMENSIONS (H*W*D) : 930*538*470 MM

SHEET CAPACITY:

S : 4 MM (30-32) **C** : 4 x 40 MM (25-27)
 : 2 x 15 MM (15-17)

HSM



HSM B22
S - RM 2,388
C - RM 2,888

WEIGHT : 11KG / 33L
 DIMENSIONS (H*W*D) : 600*375*310 MM

SHEET CAPACITY:

S : 3.9 MM (15-18) **C** : 3.9 x 30 MM (11-14)



HSM PURE 630
S - RM 5,088
C - RM 5,688

WEIGHT : 43KG / 130L
 DIMENSIONS (H*W*D) : 889*538*487 MM

SHEET CAPACITY:

S : 3.9 MM (28-31) **C** : 4.5 x 30 MM (22-27)

IDEAL



IDEAL 2265
S - RM 2,188
C - RM 2,588

WEIGHT : 10.5KG / 20L
 DIMENSIONS (H*W*D) : 516*345*213 MM

SHEET CAPACITY:

S : 4 MM (11-13) **C** : 3 x 25 MM (6-7)
 : 2 x 15 MM (4-5)



IDEAL 2445
S - RM 3,588
C - RM 3,988

WEIGHT : 21KG / 35L
 DIMENSIONS (H*W*D) : 635*395*291 MM

SHEET CAPACITY:

S : 4 MM (18-21) **C** : 4 x 40 MM (11-15)



IDEAL 3104
S - RM 6,888
C - RM 7,588

WEIGHT : 52KG / 120L
 DIMENSIONS (H*W*D) : 930*538*470 MM

SHEET CAPACITY:

S : 4 MM (30-32) **C** : 4 x 40 MM (25-27)
 : 2 x 15 MM (15-17)

Dino



DINO DELUXE

CUT STYLE	: CROSS CUT
SHRED SIZE	: 3*25 MM
SHEET CAPACITY	: 10 SHEETS
WASTE CONTAINER VOLUME	: 20L
DIMENSIONS (H*W*D)	: 560*340*263 (MM)
NET WEIGHT	: 12.4 KG

RM 888



DINO PLUS

CUT STYLE	: CROSS CUT
SHRED SIZE	: 3*20 MM
SHEET CAPACITY	: 12-15 SHEETS
WASTE CONTAINER VOLUME	: 25L
DIMENSIONS (H*W*D)	: 620*318*410 (MM)
NET WEIGHT	: 18 KG

RM 988

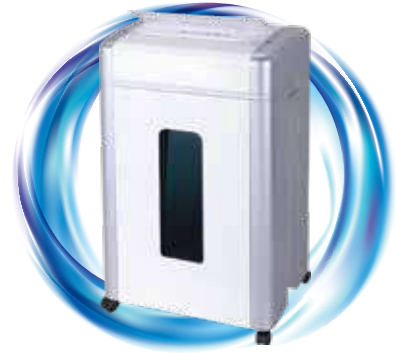

DINO SUPER GRAND

CUT STYLE	: CROSS CUT
SHRED SIZE	: 4*35 MM
SHEET CAPACITY	: 25 SHEETS
WASTE CONTAINER VOLUME	: 27L
DIMENSIONS (H*W*D)	: 693*400*310 (MM)
NET WEIGHT	: 20.5 KG

RM 1,388

BOX®



BOX HC2002D

CUT STYLE	: CROSS CUT
SHRED SIZE	: 4*44 MM
SHEET CAPACITY	: 20-22 SHEETS
WASTE CONTAINER VOLUME	: 32L
DIMENSIONS (H*W*D)	: 630*418*310 (MM)
NET WEIGHT	: 15.3 KG

RM 1,290

GBC®



GBC M515

CUT STYLE	: MICRO CUT
SHRED SIZE	: 2*15 MM
SHEET CAPACITY	: 15-17 SHEETS
WASTE CONTAINER VOLUME	: 30L
DIMENSIONS (H*W*D)	: 450*605*375 (MM)
NET WEIGHT	: 22 KG

RM 2,788

Fellowes

WORK BETTER™



FELLOWES 79CI

CUT STYLE	: CROSS CUT
SHRED SIZE	: 4*38 MM
SHEET CAPACITY	: 17 SHEETS
WASTE CONTAINER VOLUME	: 27L
DIMENSIONS (H*W*D)	: 450*390*277 (MM)
NET WEIGHT	: 12 KG

RM 1,800



FELLOWES 100M

CUT STYLE	: MINI CUT
SHRED SIZE	: 4*10 MM
SHEET CAPACITY	: 10-100 SHEETS
WASTE CONTAINER VOLUME	: 23L
DIMENSIONS (H*W*D)	: 640*390*370 (MM)
NET WEIGHT	: 14.4 KG

RM 1,750



FELLOWES 225CI

CUT STYLE	: CROSS CUT
SHRED SIZE	: 4*38 MM
SHEET CAPACITY	: 20 SHEETS
WASTE CONTAINER VOLUME	: 49L
DIMENSIONS (H*W*D)	: 732*280*520 (MM)
NET WEIGHT	: 32 KG

RM 4,850

NOTE & COIN COUNTER



CS-550

HOPPER CAPACITY : 300-500 UNITS
COUNTER SPEED : MAX. 300 UNITS/MIN
EACH RECEIVING SLOT CAPACITY : 150-300 UNITS
RECEIVING SLOT : 8 UNITS
TOTAL VALUE & QUANTITIES OF COINS
BATCH COUNT MODE & FREE COUNT MODE

RM 788



NC-250

BACK LOADING MACHINE
UV, MG, IR, DD DOUBLE NOTE, CHAIN NOTE & HALF NOTE DETECTION
COUNTING SPEED : 1,000PCS/MIN
WEIGHT : 5.3KG
DIMENSION (MM) : 292 x 248 x 175

RM 588



NC-600

FRONT LOADING MACHINE
UV, MG, DD DOUBLE NOTE, CHAIN NOTE & HALF NOTE DETECTION
SINGLE CURRENCY MIX VALUE COUNTING
COUNTING SPEED : 1,200PCS/MIN
WEIGHT : 6.2KG
DIMENSION (MM) : 265 x 250 x 252

RM 999



NC-M1600

FRONT LOADING MACHINE
UV, MG, IR & DD DOUBLE NOTE, CHAIN NOTE & HALF NOTE DETECTION
MULTI CURRENCY MIX VALUE COUNTING
COUNTING SPEED : 800/1000/1200 PCS/MIN
WEIGHT : 6.5KG
DIMENSION (MM) : 265 x 235 x 230

RM 2,888

LAMINATOR MACHINE



FGK 330

A3 LAMINATING MACHINE WITH 4 ROLLERS
SPEED : 0.5M/MIN

RM 308



SATURN 3i

NUMBER OF ROLLERS : 2
MAXIMUM POUCH THICKNESS : UP TO 125 MICRON
MATERIAL TYPE : ABS
MOUNTING BOARD CAPABLE : NO
DIMENSIONS (H*W*D) : 10.48*53.18*14.61 (MM)
NET WEIGHT : 2.31 KG

RM 670



2088 PLUS

A4 SIZE (21 HOLES)
MANUAL PLASTIC COMB BINDING
BINDING CAPACITY : 51 MM
PUNCHING CAPACITY : 20 PAGES
ADJUSTABLE MARGIN CONTROL
HEAVY DUTY

RM 488



EB-30

A4 ELECTRIC COMB BINDING
BINDING CAPACITY : 400 SHEETS
PUNCHING CAPACITY : 30 SHEETS

RM 1,688

CHEQUE WRITER



CW 388

WEIGHT : 2.3KG
DIMENSIONS (H*W*D) : 245*185*105 MM
INK ROLLER : BLACK
CURRENCY OPTION : MULTI CURRENCY
POWER SUPPLY : 220V 50Hz/60Hz

RM 328



ECT 6200

6 COLUMNS
2 COLOURS PRINTING
MONTHLY CARD
AUTO DETECTION OF FRONT & BACK
COME WITH 1 PACKET TIME CARD

RM 398



A-263 (STANDALONE)

FINGERPRINT/CARD/PASSWORD
RECORD CAPACITY : 100,000 LOGS
USER CAPACITY : 1,000
FINGERPRINT : 1,000
CARD : 1,000
PASSWORD : 1,000

RM 648



TA-100C

ATTENDANCE VERIFICATION : FINGERPRINT & PASSWORD
MICROPROCESSOR : 800 MHZ
MEMORY : 256MB FLASH MEMORY & 128 MB SDRAM
PRODUCT DIMENSIONS(LxWxH) : 190 x 52 x 140MM

RM 2,188

TIME ATTENDANCE

LCD PROJECTOR



EPSON

EB-X51

3LCD
3,800 ANSI
XGA
CONTRAST : 16,000:1

RM 2,059



EPSON

EB-W51

3LCD
4,000 ANSI
WXGA
CONTRAST : 16,000:1

RM 2,799



EPSON

EB-FH52

3LCD
4,000 ANSI
1080p WIRELESS FULL HD
CONTRAST : 16,000:1

RM 4,188

ELECTRONIC WHITEBOARD



PLUS M-18S

WRITE, PRINT AND SAVE IN COLOUR PRINTING SYSTEM
PANEL DIMENSIONS (W*H)
NO. OF PANELS
INKJET PRINTER & STAND INCLUDED

: COLOUR INKJET (A4)
: 1300 x 910 MM
: 2

RM 8,200

PLUS M-18W

WRITE, PRINT AND SAVE IN COLOUR PRINTING SYSTEM
PANEL DIMENSIONS (W*H)
NO. OF PANELS
INKJET PRINTER & STAND INCLUDED

: COLOUR INKJET (A4)
: 1800 x 910 MM
: 2

RM 8,900

FRANKING MACHINE



IS-280

call for best price

HIGH QUALITY DIGITAL PRINTING
PIN PROTECTED ACCESS
UP TO 10 PRINTED ADVERTISING
MAX ENVELOPE THICKNESS : 8MM
JOB IMPRINT MEMORIES : UP TO 5
PROCESSING SPEED : 20 LETTERS PER MIN
WEIGHT PLATFORM : 2KG IN 1G INCREMENTS
THE INTEGRATED SCALE WEIGHS UP TO 2 KG

WATCHMAN CLOCK



PR600

99 STATIONS KEY AVAILABLE
EASY OPERATION BATTERY INDICATOR LIGHT



call for best price



GUARD TOUR 9000-V5

STORAGE CAPACITY 4MB
READ RFID < 5CM
REAL TIME INTERNAL CLOCK



TEXT PERFORATOR



Perforation Sample



NEWKON 208-905

MANUAL PIN TYPE
PUNCHING CAPACITY : 15 SHEETS
SIZE : UP TO 5
OTHER MODEL AVAILABLE : 20 LETTERS PER MIN
8 DIGIT ADJUSTABLE DATE / : 2KG IN 1G INCREMENTS
NUMBERS PERFORATION WITH
FIXED LETTERS AT UPPER LINE



PRAI HEADQUARTERS

2688, Jalan Perusahaan, Kawasan Perusahaan Perai,
13600 Prai, Pulau Pinang.

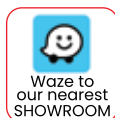

04-305 6678
www.dsop.com.my



✉ mail@dsop.com.my
f dsopoffice
@ dsopoffice



GEORGE TOWN (Opp. Balai Polis Patani Road)
276, Jalan Dato Keramat, 10150 George Town, Pulau Pinang.
04-228 7888

BUTTERWORTH (Opp. SHELL)
1286 & 1287, Jalan Baru, 13700 Prai, Pulau Pinang
04-399 2328

SUNGAI PETANI / KEDAH
04-421 2828
019-563 8127